

Supplements of *Anuario del Seminario de Filología Vasca «Julio de Urquijo»*, XXXVI

XABIER ARTIAGOITIA

VERBAL PROJECTIONS IN BASQUE
AND MINIMAL STRUCTURE

Gipuzkoako Foru Aldundia Diputación Foral de Gipuzkoa
Donostia San Sebastián
1995

SUPPLEMENTS OF ASJU
ASJU-REN GEHIGARRIAK
ANEJOS DE ASJU

- V. NILS M. HOLMER, *El idioma vasco hablado. Un estudio de dialectología vasca*, 1964, 1991. 2.000 pta. (1.600).
- VI. LUIS VILLASANTE, *Fr. Pedro A. de Añibarro, Gramática vascongada*, 1970. 1.000 pta. (800).
- VII. CÁNDIDO IZAGUIRRE, *El vocabulario vasco de Aránzazu-Oñate y zonas colindantes*, (índice inverso de Gerardo Markuleta), 2. arg. 1994. 2.000 pta. (1.600).
- VIII. *Papers from the Basque Linguistics Seminar. University of Nevada. Summer 1972, 1974.* 1.200 pta. (1.000).
- IX. JULIEN VINSON, *Essai d'une bibliographie de la langue basque. Con las anotaciones del ejemplar de Julio de Urquijo*, 1984. 3.000 pta. (2.500).
- X. LUIS MICHELENA, *Sobre historia de la lengua vasca*, 1988. Out of print.
- XI. LUIS MICHELENA - IBON SARASOLA, *Textos arcaicos vascos. Contribución al estudio y edición de textos antiguos vascos*, 1989. 2.000 pta. (1.500).
- XII. HUGO SCHUCHARDT, *Introducción a las obras de Leizarraga*, 1989. 1.000 pta. (800).
- XIII. MANUEL AGUD - † ANTONIO TOVAR, *Diccionario etimológico vasco*, I. A-Ardui, 1989. 1.000 pta. (800).
- XIV. JOSEBA A. LAKARRA (eds.), *Memoriae L. Mitxelena magistri sacrum*, 1991. 6.000 pta. (5.000).
- XV. RICARDO GÓMEZ - JOSEBA A. LAKARRA (eds.), *Euskalaritzaren historiaz I: XVI-XIX mendeak*, 1992. 2.500 pta. (2.000).
- XVI. BEÑAT OYHARÇABAL, *La pastorale soule-tine: édition critique de Charlemagne*, 1990. 2.500 pta. (2.000).
- XVII. RICARDO GÓMEZ - JOSEBA A. LAKARRA (eds.), *Euskalaritzaren historiaz II: XIX-XX mendeak*. In press.
- XVIII. JOSEBA A. LAKARRA, *Harrieten gramatikako hiztegiak (1741)*. 1994. 1.500 pta. (1.200).
- XIX. MANUEL AGUD - † ANTONIO TOVAR, *Diccionario etimológico vasco*, II. Ardu-Beuden, 1990. 1.000 pta. (800).
- XX. LUIS MICHELENA, *Lenguas y protolenguas*, 1963, 1986, 1990. 1.000 pta. (800).
- XXI. ARENE GARAMENDI, *El teatro popular vasco. (Semiótica de la representación)*, 1991. 2.000 pta. (1.600).

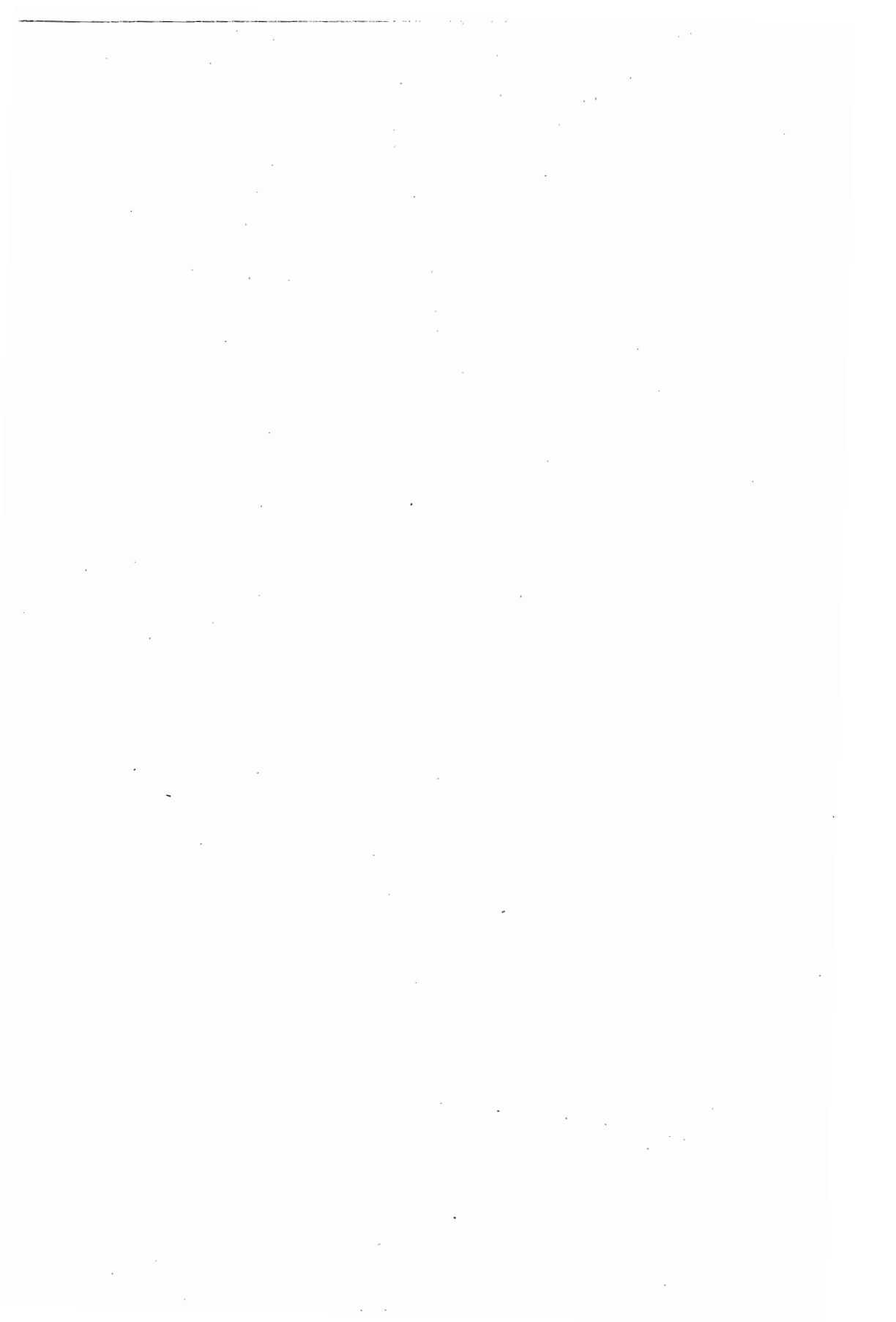

VERBAL PROJECTIONS IN BASQUE AND MINIMAL STRUCTURE

Supplements of *Anuario del Seminario de Filología Vasca «Julio de Urquijo»*, XXXVI

XABIER ARTIAGOITIA

VERBAL PROJECTIONS IN BASQUE
AND MINIMAL STRUCTURE

Gipuzkoako Foru Aldundia Diputación Foral de Gipuzkoa
Donostia San Sebastián
1995

© Seminario de Filología Vasca «Julio de Urquijo»

I.S.S.N.: 0582 - 6152

Lege-Gordailua: Donostia 400/1967

Inprimategia: IZARBERRI, S.A. - 36. Industri poligonoa, z/g - Usurbil

INDEX

Verbal projections in Basque and minimal structure.....	1
0. Introduction.....	1
1. Towards a simplified theory of the base component	2
1.1. Theoretical outline	2
1.1.1. <i>X-bar theory and syntactic categories</i>	3
1.1.2. <i>Government and the ECP</i>	4
1.1.3. <i>Case, the θ-criterion and directionality</i>	6
1.1.4. <i>Subjacency</i>	7
1.2. The base component: X-bar theory and the lexicon	7
1.2.1. <i>Lieber's X-bar theory</i>	7
1.2.2. <i>Syntax embraces morphology: the form of lexical entries</i>	11
1.2.2.1. <i>Some uses of the boundary notation</i>	12
1.2.3. <i>Lexical insertion and minimal structure</i>	14
1.2.4. <i>English ing and selection</i>	19
1.2.4.1. <i>A lexical entry for ing</i>	19
1.2.4.2. <i>Selection of gerunds and present participles and the minimal structure principle</i>	21
1.2.5. <i>Reconsidering morphology and syntax</i>	24
1.3. Basics of Basque grammar	25
1.3.1. <i>The position of heads and specifiers</i>	25
1.3.1.1. <i>N, DET, and P are final in NP, DP and PP</i>	25
1.3.1.2. <i>V is final in VP</i>	25
1.3.1.3. <i>Specifiers are phrase initial</i>	26
1.3.1.4. <i>The position of nominal adjuncts</i>	27
1.3.2. <i>Basque verbal inflection</i>	27
1.3.3. <i>Clausal word order: Basque as an INFL-initial language</i>	29
1.3.4. <i>Rightmost position of COMP</i>	35
1.3.5. <i>Other analyses of word order</i>	38
1.3.6. <i>Case in Basque</i>	39
2. The roots of nominalization in Basque	41
2.1. A DP analysis of English NP-gerunds	42
2.2. <i>te</i> in derived nominals	48
2.2.1. <i>Properties</i>	48
2.2.2. <i>Restrictions on te-derived nominals</i>	50
2.3. Nominalized clauses headed by <i>te</i>	52
2.3.1. <i>Previous analyses</i>	52
2.3.2. <i>Problems with previous analyses</i>	56
2.3.3. <i>Sentences vis-a-vis determiner phrases</i>	57
2.4. Nominalized clauses as DP-s	63
2.4.1. <i>Alternative DP analyses</i>	65
2.4.2. <i>The case of lexical subjects</i>	65
2.4.2.1. <i>Arguments for the presence of an INFL-like element inside NCs</i>	66
2.4.2.2. <i>INFL-like element = DET</i>	70
2.4.2.3. <i>Case-assignment in clausal DPs</i>	75

2.5. Some apparent clausal properties of nominalized DP-clauses	76
2.5.1. <i>Pied-piping</i>	77
2.5.2. <i>On apparent V-2 phenomena as V-I-C movement</i>	81
2.5.3. <i>Summary</i>	84
2.6. Spanish nominal infinitives	84
2.6.1. <i>Analysis</i>	84
2.6.2. <i>Extraction from English, Basque and Spanish NCs</i>	89
2.7. Final remarks	91
3. The so-called perfect participle morpheme in Basque and why it is not (always) perfect and why it is not (necessarily) participial	92
3.1. The perfect morpheme in derived morphology	93
3.1.1. <i>On the derived adjectives</i>	94
3.1.2. <i>On the derived nouns</i>	97
3.2. Non-derivational uses of the perfect morpheme	99
3.2.1. <i>Perfect nominalized clauses in adjunct positions</i>	100
3.2.1.1. <i>Verbal adjuncts</i>	100
3.2.1.2. <i>Nominal adjuncts</i>	102
3.3. The perfect morpheme in predicative contexts	106
3.3.1. <i>Stative PPs</i>	107
3.3.2. <i>The VP type of participial PP</i>	111
3.4. On the so-called passive	114
3.4.1. <i>More on tenseless relatives</i>	114
3.4.2. <i>Explaining the non-existence of the passive</i>	115
Addendum to chapter three	122
4. The lexical nature of Basque participles	124
4.1. Basque auxiliary verbs are main verbs	124
4.1.1. <i>Basque verbal forms revisited</i>	124
4.1.2. <i>Previous analyses</i>	126
4.1.3. <i>Izan and ukan as main verbs</i>	128
4.1.3.1. <i>Distribution</i>	128
4.1.3.2. <i>The syntax of verbs in Basque</i>	130
4.2. Some inconsistencies in the aspect phrase hypothesis	135
4.2.1. <i>Unfulfilled predictions</i>	135
4.2.2. <i>The problem posed by locative PPs</i>	137
4.3. Aspect markers are lexical heads	140
4.3.1. <i>The non-perfect participle as a PP</i>	140
4.3.1.1. <i>The non-perfect participle as complement to auxiliary verbs</i>	140
4.3.1.2. <i>Non-perfect participles cannot be clausal</i>	144
4.3.1.3. <i>Non-perfect participles and grammatical PPs revisited</i>	146
4.3.2. <i>The perfect participle</i>	150
4.3.3. <i>The future participle</i>	152
4.3.4. <i>Feature percolation: coordinating solutions</i>	155
Glossary	160
List of references.....	160

0. Introduction*

This work studies the structure of non-finite verbal projections in Basque and the nature of the grammatical formatives associated with them within the framework known as the Principles and Parameters approach to language (Chomsky 1986a, 1991). The central tenet of this research program states that there exists an invariant system of principles of Universal Grammar, genetically given, and that language particular variation arises as a result of specific settings of parameters and idiosyncratic properties of “non-substantive” elements of the lexicon.

In what follows, I attempt to show that a fair amount of syntactic variation specific to Basque is a consequence of the lexical properties of grammatical formatives in this language; moreover, these (grammatical formatives) do not necessarily correlate with the notion functional category in the sense of Fukui & Speas (1986), as I will clarify. More specifically, I concentrate on the analysis of the Basque nominalizing morpheme *te* (with its morphophonological variant *tze*), the perfect morphemes *i/n/tu*, their English counterparts *ing* and *en*, and the maximal phrases they project in the syntax.

I propose that some of these projections are selected and subcategorized as verbal heads. It is demonstrated here that the apparent neutralized character of these projections, i.e. the mismatch between their internal structure and their external distribution, can be adequately explained only by a theory which incorporates both syntactic and morphological information into subcategorization and selection.

In chapter one I outline the theoretical apparatus assumed throughout the article; specific attention is given to X-Bar theory and subcategorization, as well as to the interaction between morphology and syntax. I introduce and adopt Emonds' (1985, 1990) hypothesis that morphemes may be inserted at D-S (when insertion is conditioned or induced by some purely semantic feature) or after S-S otherwise. I refer to this as *the Double Lexical Insertion Level Hypothesis*. Some basic facts about the head-parameter and clausal structure in Basque are succinctly discussed as a general background for the next chapters.

Chapter two analyzes the properties of the Basque nominalizer *te*, which forms both derived nominals and nominalized clauses or DP-clauses similar to English DP-gerunds (NP-gerunds in traditional terms). I argue against previous analyses

* What follows is a virtually unmodified version of chapters one through four of my dissertation (Artiagoitia 1992a). Despite the crucial changes that the Principles and Parameters theory has known since its writing (cf. Chomsky 1992, 1994) and the various modifications that are possible, I have decided to publish the “creature” as it was conceived mainly because (it is hoped) the crucial insights have survived and the many dubious points still merit severe criticisms. The reader already familiar with the basics of Basque may want to skip most of chapter one. I would like to thank J. Lakarra for his insistence on my getting this work ready for publication. I would also like to express my deepest appreciation to the individuals that played a crucial role somehow when writing this dissertation: J. Emonds, H. Contreras, K. Zagona, J. Ortiz de Urbina, A. Eguzkitza, A. Olarrea, B. Oyharçabal, J.I. Markaida, I. Gomez Barrondo, A. Irizar, I. Markinez, G. Elordieta, A. Brugos, M. Galvaó, J.I. Artiagoitia. Special thanks to K. Zuazo and the audience of UEU (1994) for helping me revise some data of chapter two.

which hold that these DP-clauses are dominated by a CP node, and propose a unified lexical entry for *te* which predicts the formation of both types of DPs, despite the fact that DP-clauses are selected as +V. I claim that the *te* is inherently specified for aspect features when subject to late lexical insertion. I propose to derive the availability of nominative case inside DP-clauses from the existence of [V-N] to D movement, which allows D to be a nominative case-assigner.

Chapter three concentrates on the so-called perfect morpheme in Basque (with its variants *i/n/tu*) within the double insertion level hypothesis. I show that this morpheme is like English *en* in that it forms derived adjectives and past participles. It is, however, unlike English *en* in that it also forms derived nouns and DP-clauses of the perfective type; in the latter case, the morpheme is associated with the aspectual feature [+completed]. I argue that both nominals and adjectives derived at D-S from the perfect morpheme in Basque are associated with the same feature: the direct DP complement to the verb is absorbed by the perfect morpheme. The absence of this absorption feature when the morpheme is subject to late lexical insertion predicts another crucial difference with respect to English *en*: the absence of a verbal passive in Basque.

Chapter four takes issue with the idea argued for in Laka (1990) that an Aspect Phrase exists in Basque periphrastic verb forms (verb + auxiliary combinations). The question seems crucially dependent on a deeper understanding of the perfect morpheme and the nominalizer *te*, which are precisely the alleged "aspect" heads in Laka's analysis. I claim that the Aspect Phrase hypothesis makes predictions which are not borne out by the data, and is unable to account for the similarities between the non-perfect participle and a subclass of locative PPs. I develop an analysis of Basque participles whereby the "aspect" heads are indeed the same nominal and adjectival morphemes of chapters two and three. I argue that the mismatch between the verbal head selected by the auxiliary verbs *izan* and *ukan* ('be' and 'have') and the maximal projection headed by the selected verbs (PP and AP participles) is actually expected and predicted in the framework of Emonds (1990) and chapter one.

1. Towards a simplified theory of the base component

1.1. Theoretical outline

The Principles and Parameters model of grammar assumes the levels of representation in (1a); the properties of each level and the relations among them are determined by a restricted set of subsystems and principles in (1b):

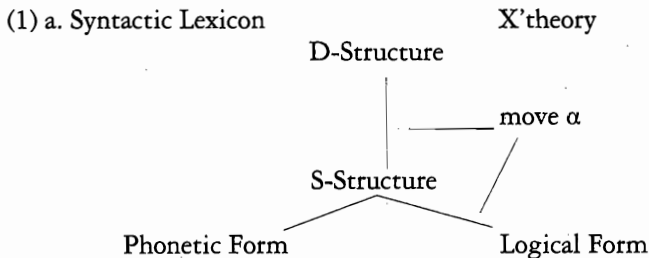

b. X-Bar Theory
 θ -Theory
 Government Theory, Empty Category Principle
 Case-Theory
 Bounding
 Binding
 Control

An overarching principle of the model is the *Principle of Full Interpretation* which requires that every element that appears in a well-formed structure be licensed (Chomsky 1986a). In other words, Universal Grammar (UG hereafter) does not allow superfluous elements. In the following sections, I omit any mention of the subtheories of Binding and Control, which are not directly related to the topic of this work.

1.1.1. X-Bar theory and syntactic categories

I assume that UG has an inventory of a) lexical categories defined by the features $[\alpha N, \beta V]$ as proposed in Chomsky (1970): verbs ($[+V, -N]$), nouns $[+N, -V]$, adjectives ($[+V, -N]$) and prepositions ($[-V, -N]$); and b) functional categories: Determiner, Complementizer, Inflection and Quantifier (DET, COMP, INFL and Q respectively henceforth). The relation between lexical and functional categories is unique unless stipulated otherwise: DET invariably has a noun phrase complement, INFL (both $[+finite]$ or $[-finite]$) a verb phrase complement, and COMP an IP complement. I further assume that the category VP does not exist outside its relation to INFL¹. As in Fukui & Speas (1986), I assume that functional categories may assign functional features such as $[+wh]$, $[+nominative]$, $[+genitive]$ (usually to their specifiers as part of the Spec-Head agreement relation proposed in Chomsky 1986b). Furthermore, if a member of a functional category is specified to assign some f(unctional)-feature, it *must* obligatorily assign that feature under certain conditions in order to avoid violating its subcategorization properties and, ultimately, the Projection Principle:

- (2) *Principle of Functional Feature Assignment*: If α , a member of a functional category F, is lexically specified to assign some f-feature, then α within F^{\max} must assign that f-feature.

I henceforth adopt the following X-Bar schemata, adapted from Lieber (1992: 39), where X ranges over both lexical and functional categories:

$$(3) \quad \begin{aligned} X'' &= XP * X' \\ X' &= X^0 XP * \\ X^0 &= X^0 * X^0 \end{aligned}$$

(1) This is the subject matter of chapter five in Artiagoitia (1992a), omitted here. I argue there that "participial VPs" are universally either AP or PP; in other words, that participial morphology always involves grammatical formatives of category A or N-P combinations. Consequently, true VPs only exist as sisters to INFL.

$$[\alpha^* = \alpha \text{ is iterable}]$$

$$[X'' = X^2; X' = X^1]$$

Base-generated adjunction to X'' is in principle possible. XP^* in X'' is the specifier of X ; XP in X' is the complement of X . The motivation for the possibility of expanding X^0 as in the last specification is discussed below in section 1.2.1. I will consider that α is a projection of β if α is a head, α and β share features, and the index of α is higher than zero; in particular an X^0 never qualifies as a "projection" of any head. The position of the head with respect to both complements and specifiers is determined by Case-Theory and θ -Theory and the head-parameter as in Koopman (1984) and Travis (1989).

1.1.2. *Government and the ECP*

The central structural relation inside X'' is that of government, which I define below:

- (4) Government: X governs Y iff X m -commands Y
- (5) X m -commands Y iff neither X nor Y dominate each other, and the first X^{\max} dominating X dominates Y

Following Rizzi (1990), I distinguish two kinds of government relations: head-government and antecedent-government. I assume with Rizzi that antecedent-government is a condition on chain-formation and reduces to Binding in the case of referential expressions. I adopt Rizzi's principle of Relativized Minimality; α in (6) ranges over "head" and "antecedent":

- (6) *Relativized Minimality*: X α -governs Y only if there is no Z such that
- (i) Z is a typical potential α -governor for Y
 - (ii) Z c -commands Y and does not c -command X

In this article I will be mainly concerned with head-government and X^0 -movement, for which the qualifications in (7) are needed:

- (7) a. Z is a typical potential governor head-governor for $Y = Z$ a head m -commanding Y
- b. Z is a typical potential antecedent governor for Y , Y in an X^0 -chain = Z is a head c -commanding Y . (Rizzi 1990: 7)²

I also assume that some rigid barriers to head and antecedent government may exist outside the relativized system, although this issue is peripheral in this article. The crucial assumption throughout this work is that a head always governs the specifier of a complement and that a head invariably protects its complements from an external governor.

(2) In Rizzi's (1990: 7) theory, the definitions of potential A- and A'-antecedents are as follows:

- i. Z is a typical potential antecedent governor for Y , Y in an A-chain = Z is an A specifier c -commanding Y .
- ii. Z is a typical potential antecedent governor for Y , Y in an A'-chain = Z is an A' specifier c -commanding Y .

Empty categories must obey the Empty Category Principle:

- (8) *Empty Category Principle*: A non-pronominal empty category must be properly head-governed (where "properly" means governed within the immediate projection). (Rizzi 1990: 87)

Following Aoun et al. (1987), I will assume that the ECP (the Head Government Requirement) applies at PF³. The ECP is relevant for the discussion of Spanish infinitives in chapter two.

I will assume that movement of heads is constrained by Travis's Head Movement Constraint (HMC hereafter):

- (9) An X⁰ may only move into an Y⁰ that properly governs it (Travis 1991: 352).

In Travis's (1991) theory, an X⁰ is properly governed by a head A if X⁰ is the head of the complement of A. This definition conflicts with the definition of proper government given in (8); for the purposes of this article, I reformulate the HMC as follows:

- (10) *Revised Head Movement Constraint*: An X⁰ may only move into an Y⁰ that is its minimal (closest) head-governor.

Although the HMC is probably subsumed under the well-formedness conditions of X⁰ chains as in Rizzi (1990), I will continue to refer to the HMC as an independent constraint for ease of exposition ⁴.

(3) If PF is indeed a pure phonetic representation as argued in Chomsky (1992), then the ECP applies at a level prior to PF but post-transformational (after S-S). Note that the proponents of Lexical Phonology (cf. Kaisse 1985) also distinguish between postlexical rules which are sensitive to syntactic bracketing and postlexical rules which are not (= apply across the board).

(4) In Rizzi's (1990) initial system, all empty elements require head-government and antecedent government. Rizzi opts for reducing the latter to binding (in the case of referential expressions) and general conditions on chain formation. In particular, he claims that the head-government requirement for empty heads is subsumed under antecedent government and Relativized Minimality (1990: 118) and thus does not fall under his final formulation of the ECP (the one given in (8) in the text). Travis' account presupposes a different formulation of proper government and makes different assumptions about X⁰ movement:

- i. *Empty Category Principle*: Empty categories must be identified
- ii. *Identification*: An empty category is identified iff
 - a) the gap is properly governed, and
 - b) the features of the gap are recoverable
- iii. *Proper government*: A properly governs B iff A governs B and
 - a) B is a complement or the head of a complement of A, or b) A is antecedent for B (Travis 1991: 351)

Travis' view differs from Rizzi's in two respects: a) proper government includes government of an X⁰ head by a head outside the immediate projection of X⁰; and b) there is a recoverability condition as part of the ECP. According to Travis, recoverability is attained through binding. Heads, however, do not have indices; hence, the recoverability of features of heads depends on the head's being "close enough":

- iii. *Restriction of head feature transmission*: Head features may only be transmitted from a head to its sister (Travis 1991: 354)

In short, whether the locality restrictions on head-movement are reduced to conditions of X⁰ chains (= antecedent government as in Rizzi (1990) and not part of the ECP proper) or feature transmission and the ECP proper as in Travis, the descriptive generalization is the same: heads can only move to the closest governing head. See Baker (1988), who also proposes reducing the HMC to the ECP.

1.1.3. Case, the θ -criterion and directionality

Every argument must play some semantic or θ -role in a larger structure. The condition on proper assignment of θ -roles is called the θ -Criterion, which I define informally:

- (11) *θ -Criterion*: Each argument α must be assigned a θ -role, and each θ -role is assigned to one and only one argument (adapted from Chomsky 1981: 335)

Given this version of the θ -Criterion, an argument can indeed receive two θ -roles from two heads (cf. also Chomsky 1986a). In Emonds (1985), the θ -Criterion is refined as to allow one argument to receive two θ -roles from two heads only if these are *not θ -related*:

- (12) Two heads are θ -related iff the maximal projection of one bears a θ -role with respect to the other
- (13) *Revised θ -Criterion*: θ -relatedness is an anti-transitive relation (Emonds 1985: 78).

Noun phrase arguments ("DP"s) must be visible in order to receive a θ -role:

- (14) An element is visible for θ -role assignment only if it receives case

In particular, V and P assign objective case to a sister noun phrase they govern; α and β are sisters if they are both dominated by the exact same projections. I adopt Koopman & Sportiche's (1991) proposal that subjects originate VP-internally and that INFL can assign nominative case by government or by specifier-head agreement, the choice being subject to parametric variation: in English and French finite clauses nominative is assigned by agreement between INFL and its specifier. Put differently, INFL is a raising category in these two languages:

- (15) English

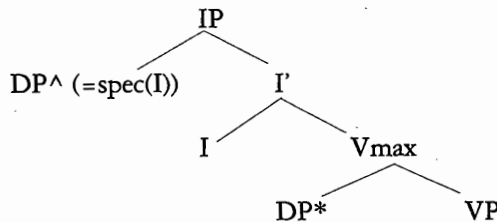

In Welsh and Irish finite clauses, on the other hand, the subject need not raise to spec(I) to receive case by agreement and can receive governed case from INFL. In Arabic both possibilities are realized with different surface orders (SVO vs VSO). I return to this issue as it applies to Basque in section 1.3.2.

The directionality of case- and θ -role assignment determines the linear order in the X-Bar schemata. As in Travis (1989), I assume that if the subdomain of θ -role or case-assignment is set, then the head-parameter is uniform for all categories in the

language (i.e. nothing else can be specified). If no subdomain direction is set for case or θ -role assignment, the value for headedness must be specified; crucially, it need not be the same across categories. This is the case of German as Travis points out. In sections 1.3.1-1.3.3, I will argue that most heads are final in Basque with respect to their specifiers and complements except for INFL, which precedes its complement.

1.1.4. *Subjacency*

For the purposes of this article, I adopt Chomsky's (1986b) version of the Subjacency Condition:

- (16) β is n -subjacent to α iff there are fewer than $n+1$ barriers for β that exclude α (Chomsky 1986b: 30).
- (17) τ is a barrier for β iff (a) or (b)
 - a. τ immediately dominates δ , δ a Blocking Category for β
 - b. τ is a Blocking Category for β , $\tau \neq \text{IP}$.
- (18) τ is a Blocking Category iff τ is not L-marked and τ dominates β (Chomsky 1986b: 14).

I understand L-marking as government by a lexical category of its complements: therefore, COMP, INFL, and DET do not L-mark their complements. Some modifications to these assumptions as they apply to Basque will be made in the course of the argumentation.

1.2. The Base Component: X-Bar theory and the Lexicon

The lexicon plays a crucial role in determining the shape of lexical structure in syntax:

- (19) *Projection Principle*: Representations at each syntactic level (i.e. LF, D-S, S-S) are projected from the lexicon, in that they observe the lexical properties of lexical items (Chomsky 1981: 29).

The projected lexical structure must conform to X-Bar theory. In what follows, I first motivate the X-Bar schemata I have adopted from Lieber (1992); second, I explain what properties I attribute to lexical entries and subcategorization.

1.2.1. *Lieber's X-Bar theory*

The X-Bar schema given in (3) differs from that of Chomsky's (1986b) in one important respect: it allows for recursion at the X^0 level.

The fundamental claim underlying this difference in Lieber (1992), to which I fully adhere in this article, is that there is no morphological component in the grammar distinct from syntax proper, and that the principles of syntax *are* the

principles of word formation as well: X-Bar theory, the head-parameter, directionality of θ -assignment, move α , the ECP and binding (cf. also Walinska 1986). The last three are of no special concern here; Lieber (1992: ch.4) shows how the three operate under X^0 in the same manner they operate "in the syntax". I will concentrate only on Lieber's motivation to reduce the specification of headedness under the X^0 level to X-Bar theory and directionality parameters.

Lieber's initial empirical observation is that certain word-formation processes involve maximal phrases: phrasal compounds, affixal case markers on a head that have scope over entire XPs, formation of verbs from XPs. If the grammar is to explain these, a theory that separates syntax from morphology will not suffice; therefore, they both must be allowed to interact. Lieber remarks that morphological theories exist (e.g. Williams 1981b, Lieber 1980, Selkirk 1982) which already share characteristics similar to those found in the syntactic component proper (at least at earlier stages of generative grammar): a) lexical entries for each affix specifying category label, subcategorization, phonetic and semantic information; b) specific rules of word formation similar to phrase structure rules:

- (20) a. $V \rightarrow \{N, A, V\} V^{af}$ (Selkirk 1982)
 b. $ize \]N, A _]V$
 [ayz]
 LCS: [CAUSE ([THING], [BE (LCS OF BASE)])]
 (Lieber's own entry)

Despite this similarity, the notion of headedness is still stipulated outside the syntax component proper:

- (21) *Right-Hand Head Rule*: In morphology we define the head of a morphologically complex word to be the righthand member of that word (Williams 1981b: 248)

Lieber reasons that as long as the direction of headedness in morphology must be established independently of syntax, it is conceivable that the two components are separate. Lieber then embarks on presenting cross-linguistic data (from Tagalog, English, Dutch, and French) to show that the head parameter in a language applies both in the syntax and in the morphology. I present here her arguments for English.

Lieber assumes the following parameter settings ("Licensing Conditions" in her terms) for English (cf. also Emonds 1985: ch.1):

- (22) *Licensing Conditions*
 a. Heads are initial with respect to complements
 b. Heads are final with respect to specifiers
 c. Heads are final with respect to modifiers⁵

(5) The motivation for condition (c) stems from the fact that NP-internal modifiers or adjuncts are generated preminimally according to Lieber; "heavy" modifiers like APs with complements, relatives, and PPs are then extraposed to the right as is the case in Heavy NP-shift. Lieber (1992) assumes that phrasal (XP) modifiers are possible under the X^0 level.

The X-Bar schema can in principle produce four different structures below X^0 according to Lieber:

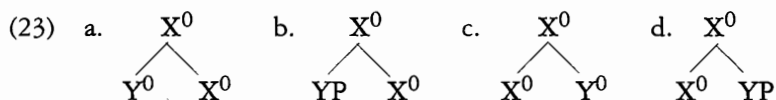

For 23a. Lieber argues that affixes that attach to adjectives/nouns and form either adjectives or nouns fall under condition (22b), since the stems will act as specifiers; therefore, they are predicted to be right-headed:

- (24) a. [[happi]_A-ness]_N b. [[fruit]_N-y]_A

Root compounds are also a subcase of modification, so (22b) predicts that they must be right-headed:

- (25) a. [[file]_N [cabinet]_N]_N (= some kind of cabinet)
b. [[green]_A [house]_N]_N (= some kind of house)

Lieber admits that deverbal nouns and adjectives are not necessarily predicted to be right headed, since verb stems do not seemingly qualify as specifiers or modifiers (they are "predicates"); but, in her view, they do not constitute evidence to the opposite effect.

As for verb forming suffixes like *ify* and *ize*, Lieber claims that that these suffixes do not assign a θ -role to their stems (the stems are predicates: *unionize* is to make X a union, *purify* is to make X pure, and so on); rather they assign a θ -role outside the derived word. Therefore, since verbs assign a θ -role to their right in English, they must assign it outside the word, leaving their internal noun or adjective stem as a predicate.

For 23b. Phrasal compounds of the type *over the fence gossip*, *ate too much headache* are also cases of modification, hence they are right headed.

For 23c. Lieber assumes that English prefixes are either specifiers (e.g. negative *un*) or adjective/adverb-like modifiers (e.g. *ante*, *co*, *re*). Alternatively, one can simply assume that prefixes lack category (the resulting word is usually of the same category as the initial word). As for category-changing prefixes, Lieber claims that only θ -assigning categories can be category-changing prefixes (they would fall under the head-complement generalization); N is excluded because, in her view, only derived nouns can assign θ -roles they inherit from a verbal stem. P is a closed class item, so it is almost impossible to derive a new member of that class by prefixation. Therefore, only verb-forming prefixes are predicted to exist, which seems correct:

- (26) a. [V de-[N bug]], [V de-[N throne]], [V de-[N fuzz]]
b. [V en[N case]], [V en[N rage]], [V en[N throne]]

The non-existence of left-headed [\bar{V} -X] compounds is left unexplained by Lieber, although she notes that right-headed [X-V] compounds are not productive either except for cases of back-formation (e.g. *babysit*, *bartend*). [P-X] compounds are excluded on general grounds again because P is a closed category by itself. Finally, the

possibility of [N-X] compounds reduces to [N-N], which in Lieber's view is excluded as a potential case of structural ambiguity. In particular: "all N-N compounds must be interpreted as right-headed" (Lieber 1992: 59)⁶.

In conclusion, Lieber claims that no morphology specific parameter or phrase structure rule other than those already specified in the syntax are needed to predict headedness under X^0 ("in morphology").

In this article I assume the correctness of Lieber's tenet that no morphological component exists outside the principles of syntax. I will interpret her proposal in a more general way: all cases of productive affixation are subsumed under the licensing conditions (or directionality parameters) for specifiers, and all cases of root-compounding are subsumed under the licensing conditions for modifiers/adjuncts. I do not adhere, however, to her analysis of category changing prefixes. Lieber herself establishes as a preliminary point that only productive affixes constitute positive and relevant evidence for a realistic theory of word-formation. In this regard, as she acknowledges, the verb forming suffix *en* is not productive and hence is not a sufficient piece of data to argue for the existence of structures like that of (23c). Similar considerations apply to *de*, which, contrary to Lieber's proposal, seems to be a non-category changing prefix (i.e. creates verbs from already existing verbs):

- (27) a. mobilize → demobilize (*demobil) c. compress → decompress
 b. moralize → demoralize (*demoral) d. range → derange

The cases of *de*'s changing category are thus restricted and non-productive. Although it is explicitly contemplated in Lieber's proposal to account for phrasal compounds, I will omit the possibility of generating phrases as daughters of X^0 , since phrasal compounds do not play any role in the discussion ahead. Therefore, we are left with the following X-Bar schema:

- (28) *Generalized X-Bar Schema:* $X'' = XP^* X'$
 $X' = X^0 XP^*$
 $X^0 = X^0 * X^0$
 $[\alpha^* = \alpha \text{ is iterable}]$
 $[X'' = X^2 ; X' = X^1]$

(6) (23d) is not discussed by Lieber. As for right-headed synthetic compounds, Lieber assumes they are derived as in (i):

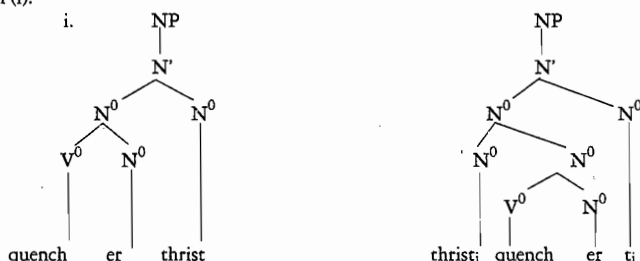

thrist receives a θ -role from *quencher*. Unless it adjoins to the noun *quencher*, it will receive case from it too, thus violating the condition that only NPs can be case-marked; central to this account is the assumption that case-marking is not a condition on θ -role assignment.

1.2.2. *Syntax embraces morphology: the form of lexical entries*

I assume here that lexical entries only contain non-predictable information about a head: the categorial membership, intrinsic features associated with the morpheme, subcategorization frame for the complement and for the latter's intrinsic features (whether semantic or syntactic), its phonetic form, and its morpheme boundaries stating whether the morpheme is bound, free or both. I specifically adopt the position that θ -grids as such do not exist and that Lexico-Conceptual Structures are not part of the lexicon. Rather, I side with Emonds (1991) in claiming that, given a properly specified lexical entry, θ -roles are predictable from subcategorization whilst the reverse is not true. By intrinsic syntactic feature I mean one that plays a role in the transformational component (or S-Structure) such as [+wh]. By intrinsic semantic feature I mean a feature that specifies classes of lexical categories and does not play a role in the syntax such as ACTIVITY, STATE, or PSYCHOLOGICAL for verbs.

Following a proposal in Baltin (1989), I reduce phrasal subcategorization (standard *c*-selection) to the form, α , +X, since *a priori* the generation of some YP is predictable from the feature +X⁷. In fact, we will see that XP *per se* may not be projected from +X. I retain, as in Lieber (1992), the notion that affixes have lexical entries of the same type as free morphemes. I propose that bound morphemes are represented in the lexicon with a missing edge boundary that must be provided by an adjacent element (whether the latter is base-generated or incorporated after the application of move α). This notation serves to minimally capture the difference between free and bound morphemes (I skip phonetic information for simplicity):

- (29) a. ity], N, +N__ {N = +latinate, ...}
 b. ness], N, +A__ {A = -latinate, ...}
 c. [anti, +__N
 +__A
 d. [read], V, +(N) (= "takes a DP")
 e. [story], N, +(N)⁸ (= "takes a DP")

This system easily allows for the representation of phrasal heads that are affixal. The Basque article is one example of this:

- (30) *a*], [+ or -definite], D, +N
 (*a* = the/a)

(30) means that a full NP complement will be projected;] indicates that no left-boundary exists for the determiner. Therefore, by S-S the leftmost member of the NP must move to D to satisfy the subcategorization property α . Finally,

(7) I depart, however, from Baltin's assumption that phrasal structure need not be projected; in my terms, a subcategorization frame of the type +X always gives rise to some YP.

(8) A residual question can be now clarified: subcategorization of the form X⁰__ is not subcategorization of a "complement" proper, but of some head, which I have equated to "specifier" following Lieber. If specifiers which are maximal projections close off maximal projections, specifiers which are X⁰'s close off X⁰'s. In this respect, Lieber's insight seems to me basically correct.

subcategorization frames of the type, $[\alpha]$, $+X$ are predicted to exist for morphemes that are independent words but can still head syntactically complex words. Words that are optionally free or bound (e.g. English *able*) can be represented as $([\] \alpha)$.

1.2.2.1. Some uses of the boundary notation

The notation for lexical items I propose has the advantage of eliminating a great deal of information that is reduplicated if morphological subcategorization is assumed to be different from syntactic subcategorization. I illustrate this claim here with two examples: the singular article *a* 'the/a' in Basque, and the postposition *ra* 'to'.

In Basque, determiners are head-final with respect to their NP complement; the singular article *a* (which may be specified as $[-/+definite]$) is a bound morpheme, and depending on whether an adjective has cliticized onto the noun and whether the head noun (or the entire NP) is ellipsed, several heads may attach to it:

- (31) a. *etxe-a*
house-art
the,a house
- b. *oso t_i etxe berri_i-a*
very house new-art
the,a very new house
- c. [*Bilboko etxe-a*] eta [*Eako-Ø-a*].
Bilbo-gen house-art and Ea-gen-Ø-art
The house in Bilbao and the (one) in Ea
- d. [*Nik eros-i dudan etxe-a*] eta [*zuk eros-i duzun-Ø-a*]
I-E buy-perf have-comp house and you-E buy-perf have-comp-art
The, a house I bought and (the) one you bought

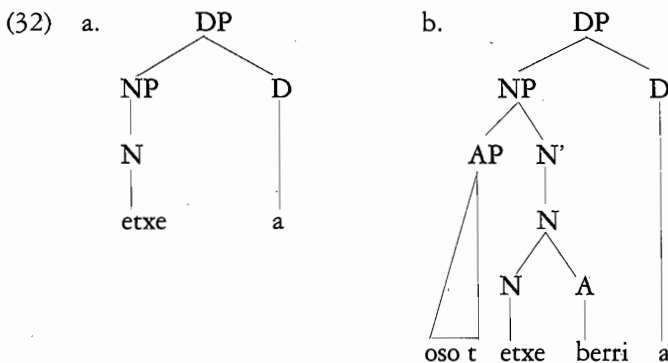

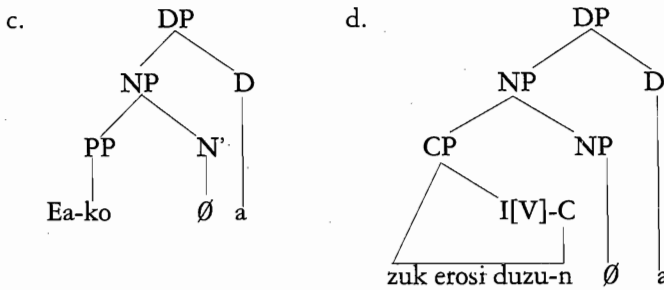

In (b) the presence of spec(A) before the noun suggests that the adjective probably originates in a prenominal position; and in fact this holds for all DP-internal adjuncts in Basque (relative clauses, PPs, most quantifiers). I assume here that this movement of the adjective to N and all the cases of head movement to DET are legitimate instantiations of move which obey Travis's Head Movement Constraint as re-formulated in (10). If we separate morphological subcategorization from syntactic subcategorization, we need a separate morphological entry for each "morphological" combination:

- (33) a. *a*, D, +NP
 b1. *a*, D, +N___
 b2. *a*, D, +A___
 b3. *a*, D, +P___
 b4. *a*, D, +C___

This multiple morphological subcategorization only obscures the predictable fact that the rightmost element of the NP must move to D, because DET is a bound morpheme; yet this information must be expressed four or five times. Under the notation I use here, (33) reduces simply to (34):

- (34) *a*], D, +N

where ...] means that *a* is bound morpheme which requires some other morpheme to provide a left boundary to form a word; which element moves to D need not be specified. Any element may move and the Revised Head Movement Constraint will rule out illegitimate derivations.

A second advantage of my proposed notation is that it can provide a minimal lexical entry for elements that can be both heads of phrases and heads of derived words, e.g. most members of category P in Basque. Postpositions in Basque are bound morphemes; hence, [P-X] derived words or compounds "look like" [PP-X] combinations. That this is not the case can be shown because true PPs which contain more than a simple [N-P] combination cannot be part of derived words or compounds:

Phrasal PPs

- (35) a. *etxe-∅-ra* 'to home, to the house' (D = ∅)
 b. *etxe berri-∅-ra* 'to the new house' (D = ∅)

*P-X derived and compound words*⁹

- | | | | |
|---------|--------------------------|----|--------------------------------|
| (36) a. | [etxe-ra]-∅ 'go home' | c. | [etxe-ra]-tze 'home-going' |
| b. | [etxe-ra]-tu 'gone home' | d. | [etxe-ra] [joalea] 'home-goer' |
| | | | (joan 'go'; joa-le 'goer') |
-
- | | | |
|---------|---------------------------|---------------------------|
| (37) a. | *[etxe berri-ra]-∅ | 'go to the new house' |
| b. | *[etxe berri-ra]-tu | 'go(ne) to the new house' |
| c. | *[[etxe berri-ra]-tze | 'new home-going' |
| d. | *[etxe berri-ra] [joalea] | 'new home-goer' |

What looks like a "PP" in (36) (i.e. the strings between brackets) is just a case of an N-P combination. If an N-A-P combination is used to form a derived word or a compound, the results in (37) are ungrammatical. The same results obtain with any combination other than N-P (e.g. N-Q-P, N-overt D-P). Using the notation I have proposed, all that is required is the following:

- (38) a. $ra]$ P, GOAL, +N (as in (35)) (= "takes a DP")
 b. $ra]$, P, GOAL, +N__ (as in (36))

The two can now be factored out:

- (39) $ra]$, P, GOAL, +N(__)

A theory which distinguishes morphology and syntax is forced to express these restrictions in a duplicated manner, and still has to stipulate that [A-P] combinations are impossible in forming derived Ps:

- (40) a. $ra]$, P, +DP (syntax)
 b. $ra]$, P, +N__ (morphology)
 +A__ (morphology; can't form derived Ps)

In conclusion, by reducing "morphological" subcategorization to subcategorization proper, we obtain a minimally simple set of lexical entries containing only unpredictable features of individual items. How both +X and +X__ frames interact is the subject matter of the next section.

1.2.3. *Lexical insertion and Minimal Structure*

The fundamental hypothesis I adopt here for lexical insertion stems from work by Emonds (1985, 1990):

- (9) The process of deriving a verb via zero suffixation is totally productive with the postposition $ra]$:
- | | | | |
|----|--|--------|--|
| i. | [[etxe-ra] _P -∅]V 'go home' | ii. a. | [mendira] 'to the mountain' |
| | | | b. [[mendira] _P -∅] 'go to a/the mountain' |
| | | | c. [[mendira] _P -tu] 'gone to a/the mountain' |

The participle is the citation form in the tradition of the South Basque Country. In the dialects spoken there, the participle is often used where the bare stem is used in other dialects.

- (41) a. *The Double Lexical Insertion Level Hypothesis*: Deep structure insertion is restricted to inserting elements associated with (either conditioned by or inducing) the presence of a purely semantic (non-syntactic) feature.
- b. Otherwise, when no semantic features are associated with insertion, S-S is always the level of insertion (Emonds 1990: 129-130).

By (41a) all elements containing some purely semantic feature (e.g. open class items) are already present at D-S, as in the classical "standard theory" of Chomsky (1965). The so-called derivational morphemes also belong under this heading since their insertion is generally constrained by some semantic feature or another; e.g. derived *ing* nominals are restricted to ACTIVITY verbs (cf. **knowing of algebra*), *ity* is at best restricted to LATINATE stems (a non-syntactic feature).

By (41b) certain closed class items (various spec(X) categories) and inflectional morphemes are subject to late lexical insertion. This proposal is motivated in Emonds (1985) in view of the fact that certain items are inserted into contexts produced only after certain applications of move α ; thus, the operation of late lexical insertion always defines or produces a post transformational (post S-S) structure. Emonds' examples include morphemes of category INFL such as *ed*, comparative *er*, the non-floating quantifier *every*, the prepositions *of* and *to* (in dative shift contexts), an alternation between *so* and *too*, the causative verb *give*, *be* itself, and so on.

One clear example is the case of "grammatical" verbs like *have* and *get*; by grammatical X is meant "a lexical item of a lexical category (N, A, V, P) which contains no purely semantic feature in its lexical entry" (Emonds 1985: 169). These grammatical verbs are transitive, i.e. they subcategorize for a noun phrase complement but they fail to undergo passivization (with a non-agentive presentation):

- (42) a. John had this car last year
b. * This car was had by John last year (E's (42a))
- (43) a. Joan got malaria during her trip
b. *Malaria was gotten by Joan during her trip (E's (42d))

Given the *grammatical* status of these verbs, they are not inserted until after S-S, namely after move α has applied. At this point, their subcategorization feature must be checked:

- (44) A contextual subcategorization feature Z^0 , $+_X^k$ of a morpheme α is satisfied only by a Lexical-Head Z^0 and a complement X^k which both dominate a terminal element at the level at which α is inserted, unless X^k is further stipulated as (possibly) empty by the feature in question (adapted from Emonds 1990: 131).¹⁰

(10) The definition of lexical head is given below. For the purposes of (42) and (43) lexical head = selecting head. Emonds (1990) uses the term *functional head*, which I replace with *L-head* to avoid confusion with functional heads such as DET, INFL and COMP.

It follows then that these verbs' complements cannot undergo passivization; when insertion of *have* and *get* takes place (after S-S), their noun phrase complements must be in their base-position in order for the transitive subcategorization feature to be satisfied.

I presuppose here that the projection of phrasal structure from the lexicon is constrained by the following principle, a subcase of the Principle of Economy of Representation (cf. Chomsky 1991):

- (45) *Minimal Structure Principle*: Co-occurrence restrictions are to be satisfied by D-S trees which contain the fewest number of phrasal nodes consistent with the principles of syntax (Emonds 1990: 136).

Thus, if a head α subcategorizes as +X, the Projection Principle and the Minimal Structure Principle (MSP henceforth) guarantees that the subcategorization frame is satisfied using the least structure possible. Since +X is the minimum unpredictable specification for α , the maximal phrase dominating X may be but need not be XP. This is the case, for example, when a head takes a DP complement:

- (46) $\alpha, Z, +X$

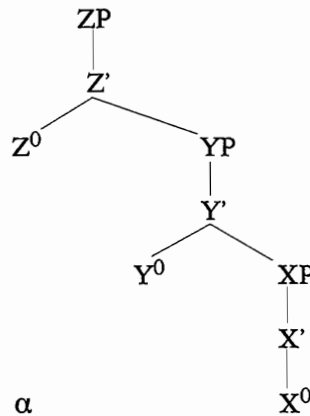

($\alpha = V$, and $X = N$, then Y must be DET)

In the case of "derivational morphemes" no conflict arises since these specifically subcategorize for non-phrasal complements (+X__). However, there exists the possibility that the subcategorization +X may require excess phrasal structure which can be avoided. In particular, suppose that $\alpha, Z, +X$ and principles of the grammar are consistent with (47):

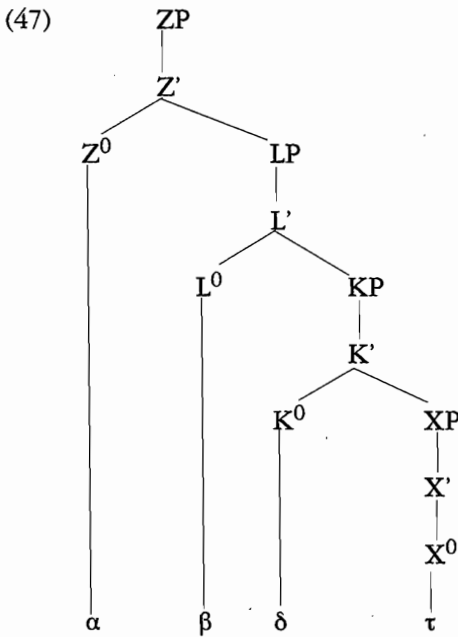

If a language contains a morpheme β, Y, +X__ which can attach to X and project YP without violating any syntactic principle, then the Minimal Structure Principle will dictate that YP (and not LP) is projected at D-S, as in (48):

- (48) a. α, Z, +X
 β, Y, +X__ (order irrelevant)

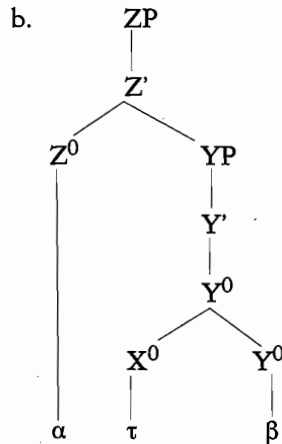

By economy of representation, +X is satisfied with fewer phrasal nodes in (48) than in (47). In view of the selection of X by α, the morpheme β can only be a morpheme that is subject to late lexical insertion (that is to say, that contains no purely semantic features); otherwise, it will impose restrictions on X that are absent in the subcategorization frame α, Z, +X:

- (49) a. $\alpha, Z, +X$
 $\beta, Y, +X$ (order irrelevant)

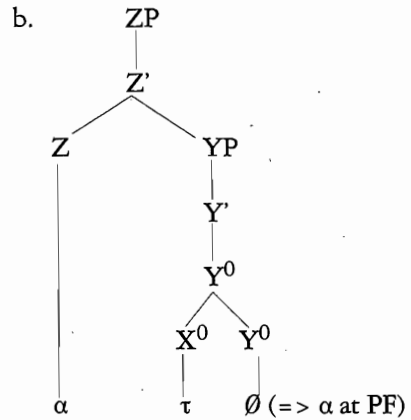

α and τ are lexically filled at D-S; Y remains empty until after S-S.

The situation in YP raises the question of what the status of X is with respect to Y, given that Y is only inserted after S-S. Following Emonds (1990), I propose to define an affixal head as the Lexical-head of any maximal phrase only if that affixal head is lexically realized at a given level of representation; this serves to disambiguate the situation in cases like (49) above:

- (50) *Lexical-head*¹¹: The L(lexical)-head of Y^2 is the rightmost lexically filled X^0 dominated by Y^2 (and by no other maximal projection under Y^2).

I assume here that the L-heads are the selectionally dominant heads inside their maximal projections and can govern and assign case across an empty Y^0 ; they also determine the range of possible adjuncts inside YP (cf. Emonds 1990). In other words, late-inserted heads in a morphologically complex word do not play a role in government relations:

- (51) *Empty Head Transparency*: Under the same Y^2 , empty heads induced by subcategorization distinct from the L-head are transparent in the syntax.
- (52) *Transparent*: A transparent head doesn't govern and doesn't block government.

Thus, *Empty Head Transparency* has the effect of making the L-head (the highest lexically filled head) the only governing head under all the same YP. As is standard, any head under a lexically filled X^0 (i.e. under the L-head) cannot govern outside that X^0 (e.g. the verb *read* in [N [V read][N er]] cannot govern across the noun). Following an idea of Emonds (1985), I assume that X^0 in (49) constitutes a sister to WP at S-S because the only terminal element under the sister of WP (= the upper Y^0) is under X^0 (and Y^0 dominates X^0)¹².

(11) The definition of L-head will require the opposite directionality in languages where specifiers follow heads, as explained earlier.

(12) Emonds' exact definition of "constitutes" goes as follows: i. D constitutes a Cj if and only if Cj dominates D and the only terminal elements under Cj are under D Emonds (1985: 38).

In what follows, I show how selection, the MSP, and the interaction of “phrasal” and “affixal” subcategorization conspire to provide minimal base structures, and how this sheds light on the nature of neutralized categories, English present participles and gerunds in particular.

1.2.4. *English ing and selection*

1.2.4.1. *A lexical entry for ing*

Emonds (1990) proposes that all uses of *ing* in English reduce basically to adjectival *ing* and nominal *ing*, and that the four way paradigm is due to the fact that, for either value, the morpheme may be inserted at D-S or after S-S. This four way paradigm includes a) derived nominals and NP-gerunds; and b) derived adjectives and present participles (what I term AP-gerunds below).

1.2.4.1.1. The following examples illustrate the nominal value of *ing*:

- (53) a. The shooting / finding / killing of the lions
 b. *The knowing / boring of Mary
- (54) We prefer John’s winning the prize to your obtaining it fraudulently
 (adapted from Emonds 1990).

As can be seen in the contrast between (53a) and (53b), *ing*-derived nominals are restricted to a subclass of verbal stems that Emonds identifies, roughly speaking, as [+ACTIVITY]. No such restriction applies to NP-gerunds¹³. He proposes the following lexical entry for *ing*:

- (55) *ing*, N, +V__ ({V = +ACTIVITY})

If the parenthesized option is chosen, *ing* must be inserted at D-S since its insertion is then conditioned by the semantic feature ACTIVITY, and we obtain a derived nominal. Otherwise, the insertion of *ing* is post-transformational since no semantic feature induces the insertion of *ing*. At D-S and S-S, a noun phrase headed by *ing* will have the following structures ((56a) is a derived nominal; (56b) an NP-gerund):

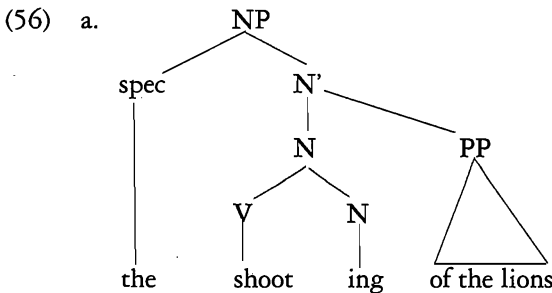

(13) I will reanalyze NP-gerunds in terms of the DP hypothesis in chapter two. I keep the NP notation in this chapter whenever the authors cited (e.g. Emonds 1990, Lieber 1992) use it.

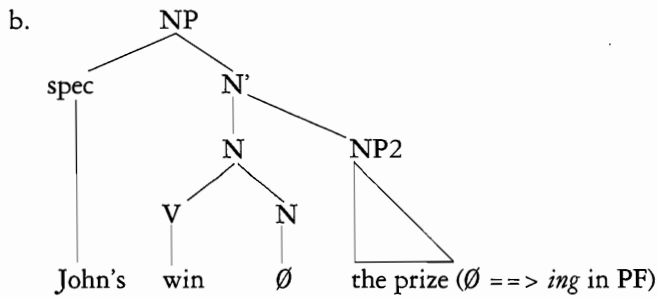

In (56a) the morpheme *ing* is both the L-head and the structural head of NP, and internal selection of complements proceeds as in a regular noun phrase. In (56b), however, the late insertion hypothesis determines that *ing* is absent in the syntax (at D-S and S-S) because it is not associated with any semantic feature. This fact alone makes the verb the L-head of NP; by virtue of *Empty Head Transparency*, the empty N does not affect the government properties of V; in particular the complements inside the NP-gerund are selected by V and V can assign objective case to *the prize*. The empty N element in (56b) abides by the ECP because the latter applies at PF, after late (post S-S) lexical insertion has taken place.

1.2.4.1.2. Consider the following examples of adjectival *ing*:

- (57) a. an amazing / exciting / boring / person
 b. *a(n) hitting / eating / speaking person

These are cases of lexical adjectives; they seem to be restricted to subclasses of verb which Emonds characterizes in general terms as +PSYCHOLOGICAL (cf. also Brekke 1988).

Emonds claims that present participles of the type traditionally referred to as “VP-ing” (they have the internal structure of a verb phrase) are dominated by an AP node of which *ing* is the head. The motivation for this position is based on the fact that these present participles occur precisely in the same environments APs do: a) in complement position to certain verbs, b) as sister to N', c) as VP/IP-adjuncts, and d) in absolutive constructions¹⁴. Each case is exemplified below:

- (58) a. We found the students *studying French* / *sick and tired*
 b. Travellers *holding American passports* / *ready to board* may go to gate two
 c. John left the room *swearing he would never study linguistics again* / *angry*
 d. With John *having obtained his degree* / *eager to leave town*, we can hit the road
 (examples adapted from Emonds 1990).

Emonds thus proposes the following lexical entry for adjectival *ing*:

- (59) *ing*, A, +V__ ({V = +PSYCHOLOGICAL}).

(14) Like APs, they too can marginally be complements to prepositions:
 i. While driving the car...
 ii. She went from happy to sad.

If the option between parentheses is chosen, we obtain a derived adjective as before and *ing* is inserted in the base (as constrained by the semantic feature PSYCHOLOGICAL). If not, then *ing* will not be inserted until after S-S. The two possible AP structures parallel to (56) are given below:

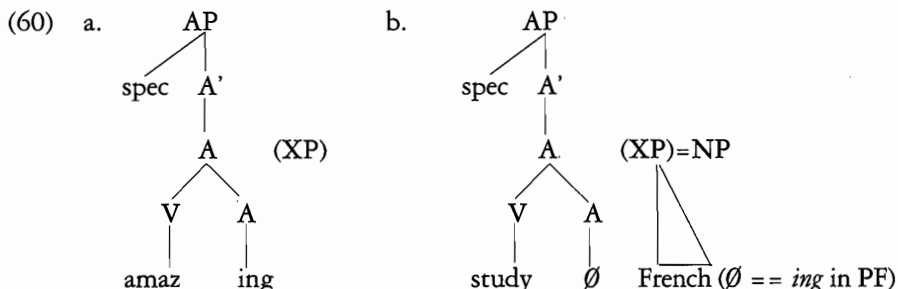

(60a) is just a lexical adjective; in (60b), on the other hand, V is crucially the L-head and, hence, can again select its complements inside AP as if in a bare “VP”¹⁵.

1.2.4.2. *Selection of gerunds and present participles and the minimal structure principle*

The characterization of present participles and NP-gerunds as headed by morphologically complex heads allows a verb to act as a selectionally dominant L-head in a phrase which is specifically *not dominated* by a CP node or a VP node. This raises the question of whether these present participles and NP-gerunds are selected as APs and NPs respectively, or as verbs. Emonds’ answer is the latter; there are verbs which take AP complements but do not tolerate AP-gerunds and there are verbs which take AP-gerunds and do not tolerate regular APs:

- (61) a. Mary feels happy / *going to the movies
- b. Mary started *happy / going to the movies

Emonds (1990) assumes then that AP-gerunds and NP-gerunds are selected as V heads while the category of the XP dominating them is determined by independent principles of the grammar; more specifically, the Minimal Structure Principle (as a subcase of Economy of Representation) and the Revised θ -Criterion.

By comparing AP- and NP-gerunds, Emonds contends that AP-gerunds are maximal with respect to V’s being their head and minimal with respect to the MSP; since NP-gerunds contain a subject position to which a θ -role must be assigned,

(15) Emonds further unifies both the nominal and adjectival *ing* lexical entries as follows:

i. *ing*, [+N], +V___, ((N: V = +ACTIVITY)
 ({A: V = +PSYCHOLOGICAL})

This entry expresses “the related nature of derivational and inflectional *ing*” (Emonds 1990: 130) and reduces the difference between Middle English (which lacked an NP-gerund) and Modern English to a minimal change in the lexical entry of *ing*:

i. *ing*(e), [+N], +V___, {N: V = +ACTIVITY }
 {A: (V = +PSYCHOLOGICAL)

The difference that gave rise to the modern English NP-gerund is the extension of the late-insertion option to nominal *ing*.

whenever possible AP-gerunds will prevail over NP-gerunds. Obviously, this is the case in non-subcategorized position (adjuncts, reduced relatives, absolute constructions) where only AP-gerunds are found. In the complement system, a few verbs which select as +V have AP gerunds: aspectuals. But these are precisely those which do not assign a θ -role to their subject:

- (62) a. keep, +V b. John kept mowing the lawn (E's (39a))
c.

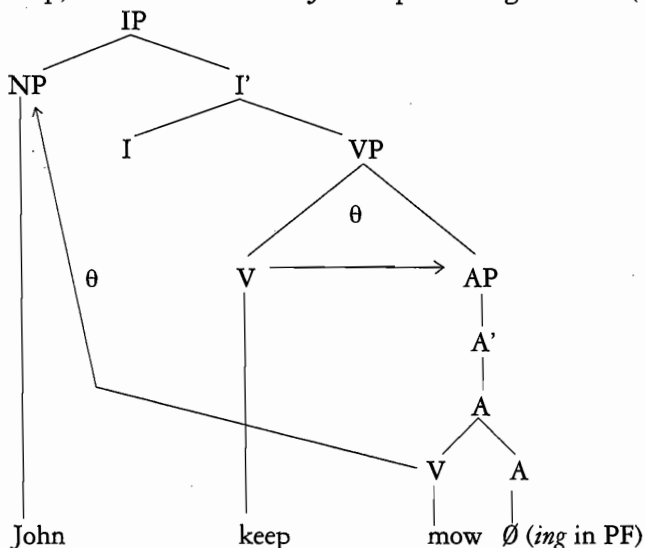

θ -roles are assigned as indicated by the arrows. The specification +V cannot give rise to NP-gerunds because, even if their extra subject position were controlled, the extra subject NP in (62b) would not receive any θ -role. Similar considerations apply to perception verbs where Emonds assumes that the verbal head assigns no independent θ -role to its object (*I caught John mowing the lawn*)¹⁶. That these gerunds are not NP-gerunds is shown by the impossibility of undergoing NP-movement in passives and clefts:

- (63) a. * It's mowing the lawn that John kept
b. * Mowing the lawn was kept by John

In sum, where no conflict arises with θ -Criterion, the preferred minimal structure which satisfies the subcategorization feature +V is an AP-gerund.

In the case of verbs which select +V and do assign a θ -role to their subject, an NP-gerund is generated to minimally meet subcategorization requirements and to allow the verb of the gerund to assign an external θ -role without violating the θ -Criterion (cf. (11) and (13) above):

- (64) a. avoid, V, +V b. John avoided mowing the lawn

(16) See Emonds (1990) for a detailed account of how θ -role assignment proceeds in perception verbs.

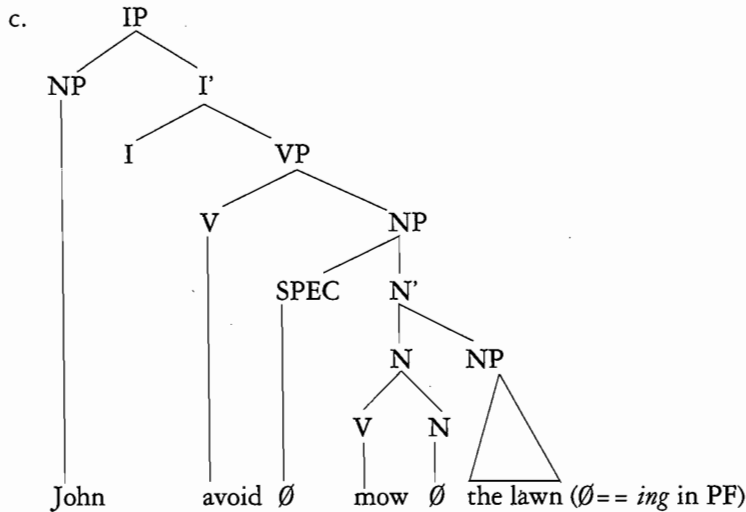

That this is a true case of NP-gerund is shown in (65):

- (65) a. It's mowing the lawn that John avoided
 b. Mowing the lawn was avoided by John

Given the selection of +V, then, the Revised θ -Criterion given in (13) in accord with the MSP determines what type of gerund (NP or AP) is generated¹⁷.

To sum up, complement subcategorization reduces to selection of heads, as proposed in 1.2.2. Some syntactic features may trigger base generation of further structure; but in the case of AP- and NP-gerunds, the frame +V is sufficient to project the necessary phrasal structure. Economy principles determine that only the needed structure is projected onto the syntax. Again, the simplification of subcategorization provides a radical explanation of the nature of neutralized phrases; these arise as a result of head-selection and the interaction of morphology/syntax as constrained by the MSP.

(17) According to Emonds, the choice between NP-gerunds and infinitives reduces to the specification of some syntactic features in the lexical entry of the selecting verbs beyond the basic +V feature: GOAL (for clauses), [+WH], M(odal) (which triggers the insertion of *to* after S-S). In this scenario, some verbs select as +M[∧]V (they only take infinitival complements):

i. John hoped {to mow the lawn / * mowing the lawn / * when to mow the lawn }

Verbs like *know* select as +WH[∧]V:

ii. John knows { * to mow the lawn / * mowing the lawn / how to mow the lawn }

A verb like *decide* selects as ((WH,GOAL))[∧]M[∧]V, which predicts it will have wh-infinitives, for-clauses and infinitives, but not gerunds:

iii. John decided {to mow the lawn / when to mow the lawn / for Mary to mow the lawn / * mowing the lawn }

Finally, verbs which optionally subcategorize for F-features (=WH, M, GOAL) are predicted to exist; *climb* for example subcategorizes as +(M)[∧]V, and hence it will have infinitival and gerundive complements:

iv. John has tried {to climb the mountain / climbing the mountain }

A similar situation obtains with verbs like *discuss*, which select as +(WH)[∧]V:

v. The lawyer discussed {buying some clothes in Rome / * what clothes buying in Rome / * to buy some clothes in Rome / what clothes to buy in Rome}.

1.2.5. Reconsidering morphology and syntax

The theory of subcategorization and interaction of morphology/syntax proposed in this chapter and illustrated with English *ing* has some implications which merit further scrutiny.

First, the proposal explicitly confirms that base-generation of complex heads exists and is constrained by both subcategorization and the MSP. At the same time, it presupposes the abandonment of the assumption of much current work (e.g. Baker 1988, Ouhalla 1991 and others) that every (inflectional) affix *must* project to a full phrase, an assumption which is rarely supported by argument. In the terms of this article, a head generated by the frame +X will project to a full phrase only if it *must*. By including boundaries in subcategorization frames, I retain the notion that head-movement may be triggered by "morphological" requirements, for example when a given head is affixal with respect to its complement sister (α], +X).

The merging of "affixal" and "phrasal" subcategorization also presupposes that constraints to the effect that bound morphemes must host some morpheme such as Baker's (1988) Stray Affix Filter¹⁸ are subsumed under the Projection Principle without any further addendum. In cases where two lexical properties cannot be simultaneously met (e.g. the Basque article, which takes an NP sister and is a bound morpheme), I propose the following convention:

- (66) *Simultaneity Convention*: If a lexical entry contains two properties P₁ and P₂ which cannot be simultaneously met at a level of representation L₀, the Projection Principle is said to be satisfied if P₁ is met at L₀..._n and and P₂ is met at L₁..._n.

It is not necessary to stipulate which one must be met first; in the case of the Basque article (which has the lexical entry α], D, [α definite], +N), if the determiner is affixed onto a noun and forms a complex determiner of the form [D N-D] at D-S, then the requirement that it takes an NP sister cannot be met at the next level of representation, since X⁰-structure would need to be modified. Suppose, on the other hand, that a deep phrase marker of the form (67) is generated:

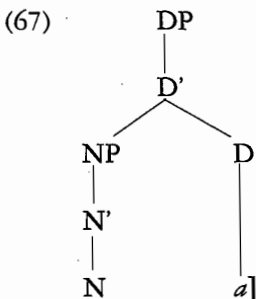

(18) **X* if X is a lexical item whose morphological subcategorization is not satisfied at S-S" (Baker 1988: 140).

Now the requirement that the determiner a host a head can and, furthermore, must be met at the next level of representation by head movement of the noun as constrained by the HMC.

The framework adopted here implicitly rejects the claim that syntax has no access to the internal structure of words as assumed by DiSciullo and Williams (1987); it does if, and only if, certain affixes are by hypothesis transparent in the sense that they are not inserted until after S-S (cf. (41) and (51) above)¹⁹. Once an X^0 is inserted, then nothing under X^0 can be analyzed. Thus, the term “weak lexicalist hypothesis” (rather than say “ X^0 hypothesis”) is appropriate for my proposal.

1.3. Basics of Basque Grammar

1.3.1. The position of heads and specifiers

1.3.1.1. *N, DET, and P are final in NP, DP and PP*

As we saw in section 1.2.2.1, Basque Determiners and Ps are last inside DPs and PPs respectively:

- (68) [[[[Etxe berri]_{NP} honeta]_{DP-n}]_{PP}
 house new this -loc
 In this new house

Complements (and subjects) to nouns also precede the latter:

- (69) Asierren Kavafis-en itzulpen hau
 Asier-gen Cavafy-gen translation this
 This translation of Cavafy by Asier

1.3.1.2. *V is final in VP*

The position of objects with respect to verbs in root clauses is more problematic because of the relatively free word order of Basque, as we shall see in 1.3.3. There are however cases of bare participial complements to aspectual verbs like *hasi* ‘start’, traditionally assumed to be VPs, which provide a testing ground for the position of the verb. Assuming for the time being that they are instances of VPs, we can see that a verb must follow the object (I disregard potential cases of object focalization or topicalization):

- (70) a. Ainhoa *egunkaria irakur-tze-n* has-i da
 newspaper read-te-loc start-perf is
 Ainhoa has started reading the newspaper
 b. * *Egunkaria Ainhoa irakurtzen* hasi da (no pause after *egunkaria*)

(19) I depart from Lieber’s claim that inflectional affixes lack a *categorial signature*. A categorial signature in Lieber’s terms is “a frame of morphosyntactic features headed by the category features [+/-N], [+/-V] that are of syntactic relevance for a particular category in a particular language” (Lieber 1988: 88-89). The categorial signature for nouns may include person/gender/number features and so on. I assume here that *inflectional features do have categorial signature and category label*: sometimes they are of the same category of the stem they attach to (the plural morpheme); sometimes they belong to a functional category (DET, INFL) (English modals, *ed*).

- c. * Ainhoa *irakurtzen egunkaria* hasi da
- d. Ainhoa hasi da *egunkaria irakurtzen*
- e. *Ainhoa hasi da *irakurtzen egunkaria*
- f. Hasi da *egunkaria irakurtzen* Ainhoa
- g. *Hasi da *irakurtzen egunkaria* Ainhoa

As can be seen from the contrasts, all the grammatical sentences have the object DP immediately preceding the verb. This indicates that verbs are also head-last with respect to their complements.

De Rijk (1969) provides other cases of tenseless structures where the verb must follow its complement. Nominalizations are one instance of this:

- (71) a. Cascabelek *Urtain bota-tze-a-k* harri-tze-n nau
 -E throw-TE-art-E amaze-TE-loc has
 Cascabel's knocking down Urtain amazes me
- b. * *Cascabelek botatzeak Urtain* harritzen nau
 Cascabel's knocking down Urtain amazes me (de Rijk 1969: 350)

The verbs of control *nahi* 'want' and *behar* 'have to/need' subcategorize for a bare infinitive. This infinitive must follow its complement, or the sentences turns out to ungrammatical:

- (72) a. Orain *sagarr-a jan* behar du
 now apple-art eat need has
- b. * Orain *jan sagarra* behar du (de Rijk 1969: 349)
- c. Orain behar du *sagarra jan* (ok, northern dialects)
- d. * Orain behar du *jan sagarra*
 Now s/he needs to eat an/the apple

According to Ortiz de Urbina (1989), *jan* and *behar* in sentences like (72a) get reanalyzed as a single verb; irrespective of this, the restriction that the verb follow its complement still holds in (72c).

The preceding paragraphs, then, show that in Basque Verbs, Nouns and Postpositions are last with respect to their complements and assign θ -roles and case to their left. Determiners also follow NPs.

1.3.1.3. *Specifiers are phrase initial*

With regard to classes of specifiers, these precede the head. Inside DPs possessive genitives and genitive subjects precede a head noun and are both compatible with a lexical determiner; I take this to imply that spec(D) and spec(N) precede D and N respectively²⁰:

(20) Quantifiers are other candidates for the spec(N) position; these generally precede the noun, although some quantifiers are postnominal:

- i. Hiru / zenbait / anitz / aski lagun heldu dira
 three some many many fried arrive-perf are
 { Three, some, many } friends have arrived
- ii. Lagun batzu / asko / gutxi heldu dira
 several many few
 { Several / many / few } friends have arrived

- (73) [DP Asierren [NP Leizarragaren Bibliaren itzulpen] hau]
 -gen -gen Bible-gen translation this
 This translation of the Bible by Leizarraga of Asier's

Specifiers of degree also precede their head in APs²¹:

- (74) Asier [AP oso / nahikoa / guztiz / zeharo azkarra] da
 very / rather / totally / absolutely smart is
 Asier is {very, rather, totally, absolutely} smart

1.3.1.4. *The position of nominal adjuncts*

As shown above in 1.2.2.1, nominal modifiers or adjuncts are invariably pre-nominal in Basque: relative clauses and PPs precede the noun. Additionally, PPs and bare DPs usually take the postposition *ko*:

- (75) a. Eros-i dudan etxe-a b. Donostiara-ko tren-a
 buy-perf have-comp house-art Saint Sebastian-adl-KO train-art
 The, a house I have bought the, a train for Saint Sebastian
 c. Begirada hitse-ko neska
 glance sad-ko girl
 The girl of sad look

Adjectives are usually postnominal. However, if a spec(A) is present, it tends to precede the noun, which suggests that APs also originate prenominally and that the adjective itself is moved onto N:

- (76) a. Oso filme (?oso) luze-a b. Hain filme (*hain) interesgarri-a
 very movie long-art so movie interesting-art
 A very long movie Such an interesting movie
 (lit: "a so interesting movie")

1.3.2. *Basque verbal inflection*

Before I turn to the structure of the clause in Basque and the position of COMP and INFL, I introduce some basics of the verb conjugation.

Only some Basque verbs (around twenty or so), which roughly correspond to the oldest native set of verbs in the language, have a synthetic form for present tenses and past (imperfect) tenses. The list includes verbs that do not seem to be semantic-

(21) Affixal spec(A) members follow the adjective:

- i. Asier azkarr-egi-a / azkarr-ago-a da
 smart-too-art -more-art is Asier is too smart / smarter

This could be taken as an argument that *egi* and *ago* are true heads. Specifiers of the category P are scarce if not non-existent; some PPs allow the specifiers *oso* and *nahiko*:

- i. Oso / nahiko goian
 very fairly top-loc
 Very (much) / fairly on the top

ally related: *joan* 'go', *etorri* 'come', *esan* 'say', *ukan* 'have', *izan* 'be', *eritzi* 'opine', *ekarri* 'bring', *jakin* 'know', *eraman* 'carry', *egon* 'stay', *etzan* 'lie', *erion* 'flow', *esan* 'say' and so on (see Euskaltzaindia 1985 for a complete list). Traditional grammarians describe these synthetic forms in the present and past as having *punctual* aspect, since they are incompatible with an habitual interpretation. Here are some examples:

- (77) a. *Ainhoa etxera doa*
home-adl goes
Ainhoa is going home
- b. *Ainhoa etxera zihoan*
went
Ainhoa was going home
- (78) a. *Ainhoak eskuan liburua dakar*
-E hand-loc book-art brings
Ainhoa is carrying the book in her hand
- b. *Ainhoak eskuan liburua zekarren*
brought
Ainhoa was carrying the book in her hand

Most of the verbal conjugation, however, is periphrastic and consists of an uninflected form of the verb (a participle) and an auxiliary verb. In these periphrastic forms, the auxiliaries *izan* 'be' and *ukan* 'have', which are themselves main verbs and have synthetic forms, may take any of the three participles: perfect, non-perfect and future. The auxiliary *izan* 'be' is used with unaccusative verbs in the sense of Burzio (1986), while *ukan* 'have' is used with transitives and unergatives:

- (79) *Ainhoa etxera {etorr-i / etor-tze-n / etorr-i-ko} da*
home-adl arrive-perf / -TE-loc / -perf-KO is
Ainhoa has arrived / arrives / will arrive home
- (80) *Ainhoak eskuan liburua {ekarr-i / ekar-tze-n / ekarr-i-ko} du*
-E hand-loc book bring-perf / -TE-loc -perf-KO has
Ainhoa has brought / brings / will bring the book

There exists a progressive construction formed with the non-perfect participle followed by the verbs *ibili* 'walk', *egon* 'stay, be' or the particle *ari* followed by *izan* 'be'. The choice among these three options depends on the dialect:

- (81) *Euskal Herriaren egoera politikoa alda-tze-n {dago / dabil / Basque Country-gen situation political change-TE-loc a} stays / walks / ari da*
ARI is
The political situation in the Basque Country is changing

This progressive construction makes up for the absence of synthetic ("punctual") forms with the majority of the verbs. One salient feature of the inflected verbs (whether they are "main verbs" or "auxiliaries") is their *poly-personal* nature (in Rebuschi's 1989) terms). By this, we mean that, besides tense and subject agreement

markers, Basque inflected verbs also contain agreement markers for the object and the indirect object²²:

- | | | | | | | | |
|------|----|-----------------------------|------------|--|----|---|---------------|
| (82) | a. | ekarr-i | d-u-∅ | | c. | ekarr-i | d-i-zu-∅ |
| | | bring-perf | 3A-root-3E | | | bring-perf | 3A-root-2D-3E |
| | | S/he has brought it/her/him | | | | S/he has brought it/her/him to you (sg) | |
| | b. | ekarri | d-u-t | | d. | ekarr-i | d-i-zu-t |
| | | bring-perf | 3A-root-1E | | | bring-perf | 3A-root-2D-1E |
| | | I have brought it/him/her | | | | I have brought it/her/him to you (sg) | |

This richness in verbal agreement licenses empty object and indirect object pronouns in Basque (i.e. Basque is a null-object and null-indirect object language), as explained in Eguzkitza (1986) and Ortiz de Urbina (1989).

Throughout this article, I assume that all these person markers are spellouts of INFL (or AGR in INFL), and that the poly-personal character of Basque arises because the verb is capable of carrying three indices (the indices of three DP arguments) when it moves to INFL²³. In principle, I dissociate these morphemes from case-marking of DPs; this seems justified since the same range of case-marking possibilities holds even when inflected main verbs or auxiliaries are absent; i.e. in tenseless clauses and in nominalizations, as we shall see in chapter two.

1.3.3. Clausal word order: Basque as an INFL-initial language

I have deliberately delayed the discussion of what the position of INFL and COMP is in Basque. The matter is not trivial and requires a more detailed discussion than I can possibly offer in an introductory chapter, nor is the focus of this article. I suggest below that IP is head-initial and that CP is head-final in Basque. This proposal should be regarded as an intermediate step in the search for a definitive solution to the murky issue of Basque word-order. I will outline my tentative proposal and briefly show how it accounts for the different word order patterns found in Basque.

There is a general consensus among most Bascologists (cf. de Rijk 1969, Goenaga 1980, 1984, Eguzkitza 1986) that Basque is an SOV language. This is also the opinion of the official grammar of the Basque Academy (cf. Euskaltzaindia 1985). Nonetheless, when explaining the data, all discussions about word order in Basque contain lengthy explanations about how the syntax of focused phrases is similar to that of wh-phrases; and how these two constructions are similar to that of sentences with negative and emphatic "particles" or operators.

(22) See Laka (1988) for a thorough analysis of these verbal paradigms in terms of Baker's *Mirror Principle* (1988). There are also allocutive forms for colloquial speech which display an extra agreement marker with the "listener" or addressee.

(23) In Lieber's (1992) terms, the categorial signature of the verb in Basque can include three specifications for number/person, which are "filled out" after the verb moves to INFL. I assume with Emonds (1985) that datives are PPs with an empty P at D-S and S-S, filled in at PF. Nonetheless, the DP in a dative "constitutes" a sister to the verb at D-S and S-S in that the only terminal lexical elements under a dative PP are under DP.

In fact, in the absence of more data concerning unacceptable orders, one wonders sometimes if there is an “unmarked” order in Basque at all²⁴. I will maintain here that Basque is *indeed* an SOV language at D-S; the same is true at S-S in certain cases, but I propose to derive the unstability of word order from the fact that INFL precedes VP in Basque. In other words, a Basque clause looks like the following at D-S:

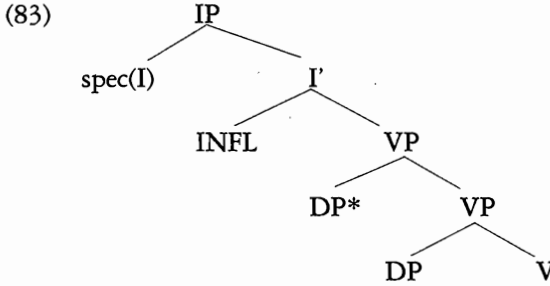

Under this analysis, INFL assigns nominative case to DP* under government, and *not* by agreement with a DP in spec(I) (cf. Koopman & Sportiche 1991). This leaves spec(I) as a possible landing site for moved phrases. My contention is that the following parametric choice holds of Basque INFL:

- (84) *Basque INFL*: Every [+finite] α , α a member of (functional category) INFL, assigns the feature [+operator] to some overt element in spec(I)

(84) simply states that the f-feature assigned by a finite INFL in Basque to its specifier is [+operator]. In other words, the Spec-Head agreement relation within IPs in Basque always involves the feature [+operator] (and not, say, [+nominative] as in English according to Koopman & Sportiche 1991). I include wh-phrases, focused XPs, and affective predicates in the sense of Klima (1964) as potential recipients of the feature [+operator]. Whichever features these elements inherently have, they move to spec(I) and INFL as a result assigns (“discharges”) the f-feature [+operator]. This proposal has a series of important ramifications that I explore henceforth.

As is well-known in the tradition of Basque linguistics since Altube (1929) and de Rijk (1969, 1978), focused XPs and wh-phrases behave alike in that both must usually be adjacent to the verb²⁵:

- (85) a. *Nora doa Ainhoa ordu honetan?*
 where goes time this-loc
 Where is Ainhoa going at this time ?

(24) Mitxelena (1981) analyzes four possible word orders for the sentence *hau ona da* “this is good”:

i. *Hau ona da* ii. *Hau da ona* iii. *Ona hau da* iv. *Ona da hau*

He explains them in terms of which XP is the topic and which one the focused phrase; but he does not say whether a certain order (e.g. (i)) may be interpreted as lacking both.

(25) The reason adverbial and, to a lesser degree, the wh-phrase *nola* ‘how’ seem to be exceptions to this generalization; cf. Mitxelena (1981), Laka (1985). This exception is accounted for if, as proposed in Rizzi (1990), the reason adverbial is generated in spec(C). The same can be proposed for *nola*.

- b. *ETXERA doa* Ainhoa ordu honetan
home-adl
It's home that Ainhoa is going
- c. **Nora* Ainhoa *doa* ordu honetan ?
- d. **ETXERA* Ainhoa *doa* ordu honetan

Although other constituents may precede focused and wh-phrases, they usually behave like topics in that such elements are pronounced with "a characteristic listing intonation" (Ortiz de Urbina 1986: 225; cf. Eguzkitza 1986):

- (86) a. Ainhoa / ordu honetan / *nora doa* ?
- b. Ordu honetan / Ainhoa / *nora doa* ?

I assume here that these topics are adjoined to IP. The negation and emphatic markers (*ez* and *ba*) must also precede the inflected verb; in fact they may as well be considered affixes on the inflected verb²⁶. The same is true of other operator-like elements of the type studied by Klima (1964) and de Rijk (1972b):

- (87) a. *Ez dator* Ainhoa etxera (88) a. *Ba dator* Ainhoa etxera
 No comes home-adl yes comes home-adl
- b. **Ez* Ainhoa etxera *dator* b. **Ba* Ainhoa etxera *dator*
 Ainhoa is not coming home Ainhoa IS coming home
- (89) a. *Ainhoa bakarrik dator* etxera b. **Ainhoa bakarrik* etxera *dator*
 only Only Ainhoa is coming home
- (90) a. *Nekez uzten* *du* bere sorterrria sustraiak han dituen-a-k
 hardly leave-TE-loc has his/her homeland roots there has-comp-art-E
 Hardly does the one who has roots there leave her/his homeland
- b. **Nekez* sustraiak han dituenak bere sorterrria *uzten du*

Following Eguzkitza (1986) and Ortiz de Urbina (1989), I adopt the position that *ba/ez* are heads generated under INFL; in this case, the feature [+operator] can be assigned internally by INFL to the adjoining head, as in (91):

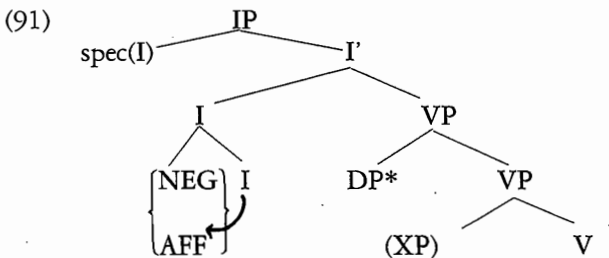

(26) It is only because of an orthographic convention that *ez* 'not' is written as an independent word nowadays. The only elements that can appear between *ez/ba* and the inflected verb are the so-called modal particles, which are generally assumed to be base-generated under the INFL node (cf. Eguzkitza 1986, Ortiz de Urbina 1989):

- i. [*Ez omen* *dator*] Ainhoa etxera
 neg apparently comes home-adl
 Ainhoa is apparently not coming home

This INFL-internal assignment requires that we add the following to (84):

(84)' ... in spec(I) or in INFL

When the *f*-feature [+operator] is assigned INFL-internally, however, the subject DP* may move to spec(I) without being interpreted as a focused phrase. This is actually the preferred order in negative sentences:

(92) *Ainhoa ez dator etxera* (cf. (87a))
Ainhoa is not coming home

Nonetheless, INFL may assign its *f*-feature to a *wh*-phrase or, more marginally, to a focused phrase, in the presence of negation. This is impossible with the emphatic morpheme *ba*:

(93) a. *Nor ez dator etxera?*
who no comes home-adl
who is not coming home?
b. *?AINHOA ez dator etxera*
It's Ainhoa that is not coming home

(94) a. **Nor ba dator etxera ?*
who aff comes home-adl
It's Ainhoa that IS coming home
b. **AINHOA ba dator etxera*
Who IS coming home ?

This means that negation, unlike the affirmative morpheme, *may but need not agree* with INFL.

A sequence of a participle and an auxiliary verb can also be sentence-initial; I will analyze these participles in detail in chapter four. For the present discussion, I assume that these structures may appear in INFL because the main uninflected verb (i.e. the participle) is coindexed with the auxiliary verb as proposed in Chomsky (1986b) and hence may adjoin to INFL without violating any syntactic constraint:

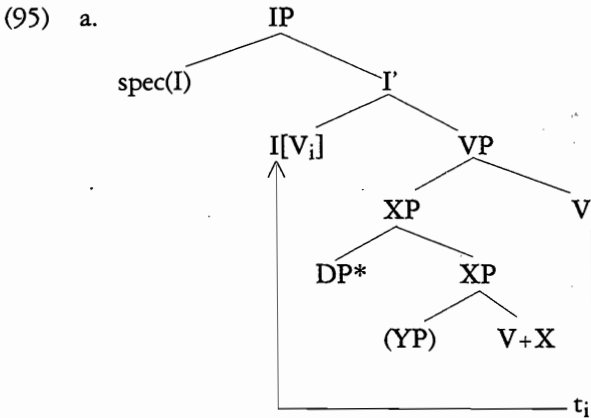

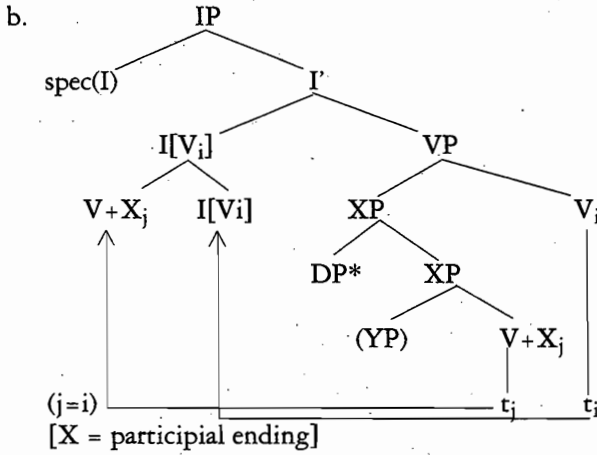

This adjunction complies with the Head Movement Constraint. Given Chomsky's (1986b) contention that auxiliary verbs are coindexed with main verbs in V* constructions, the indices *i* and *j* are probably the same and the entire [I_i ...t...t] counts as a unimember chain; no head intervenes and relativized minimality is respected.

Another means for explaining why [X V+X] can adjoin to INFL is to consider that the complex head INFL governs XP after movement of the auxiliary as in Baker (1988); then t_i does not constitute a closer head or a barrier to (antecedent) government of t_j by the new INFL containing V+X;²⁷

If nothing occupies the spec(I) position, INFL will internally assign the feature [+operator] to the participle (regardless of which account of participle adjunction is chosen). This seems appropriate; participle-initial sentences are interpreted as V-focalization (cf. Ortiz de Urbina 1989):

- (96) *etorr-i da Ainhoa etxera*
 arrive-perf is home-adl
 What Ainhoa did was come home

If some XP occupies the spec(I) position, then XP rather than the participle agrees with INFL and receives the focus interpretation²⁸:

- (97) *ETXERA etorr-i da Ainhoa*
 home arrive-perf is
 It's home that Ainhoa has come

(27) This complies with Baker's *Government Transparency Corollary*: "A lexical category which has an item incorporated into it governs everything which the incorporated item governed in its original structural position" (Baker 1988: 64).

(28) In V + auxiliary complexes, if some XP occupies the spec(I) position the participle may also remain in its base-position; the resulting order is stylistically marked:

- i. *Nora da Ainhoa etorr-i?* ii. *ETXERA da Ainhoa etorr-i*
 where is arrive-perf It's home that Ainhoa has come
 Where has Ainhoa come?

I will return to this matter in chapter four.

By identifying the left position of operators in Basque with $\text{spec}(I)$, we can derive the impossibility of having a sentence-initial inflected verb from general principles of UG:

- (98) a. *dator Ainhoa etxera b. *da Ainhoa etxera etorr-i
 comes home-adl is home come-perf
 Ainhoa is coming home Ainhoa has come home

If INFL is filled with some lexical item, then it must agree with an operator-like element. This follows from (84) and the Principle of Functional Feature Assignment in (2), which forces a member of a functional category (INFL in this case) to obligatorily assign its f -feature under certain conditions:

- (2) *Principle of Functional Feature Assignment*
 If α , α a member of a functional category F , is lexically specified to assign some f -feature, then within F^{max} must assign that f -feature

If a filled INFL remains in situ, sentences (98a, b) are ungrammatical because INFL does not assign its f -features (it cannot vacuouly assign it to an empty position) and (2) is violated. The only way for a sentence without operators not to violate this requirement is for INFL to move somewhere else; I suggest that this is exactly what happens in the unmarked verb-final order. INFL moves to an empty COMP (a substitution movement), and then a lexical item under INFL need not assign its f -feature (since INFL is no longer contained in IP):

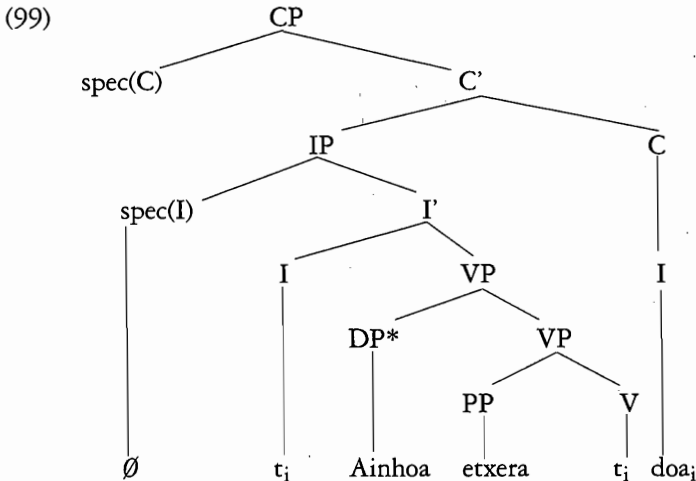

In accord with Economy of Representation (cf. also Travis 1991), it is plausible that no COMP node need be generated in matrix clauses if $\text{spec}(I)$ is filled and INFL assigns its functional feature within IP as part of Spec-Head agreement; the substitution movement to COMP takes place as a "last resort" for INFL not to violate the Principle of Functional Feature Assignment in (2). I now turn to the motivation of COMP as CP-final in Basque.

1.3.4. *Rightmost position Of COMP*

Complementizers in Basque are bound morphemes on inflected verbs. That the COMP position is final in Basque is supported by the fact that words consisting of an *inflected verb* and a *complementizer* are sentence final in many non-root clauses. Relative clauses are a clear example of this:

- (100) a. Asierrek gaur Ainhoari idatz-i *dio-n* gutuna
 -E today -D write-perf has-comp letter
 b. *Asierrek idatzi *dion* Ainhoari gaur gutuna
 The letter that Asier has written to Ainhoa today

The same is true of subordinate clauses that involve sentential complements other than to verbs of saying and thinking:

- (101) a. Asierrek Ainhoari gutuna idatz-i (*ez*) *dionetik*...
 -E -D letter write-perf (no) has-comp
 Since Asier has (not) written a letter to Ainhoa
 b. *Asierrek *ez dionetik* Ainhoari gutuna idatzi...
 Since Asier has not written a letter to Ainhoa
 c. *Asierrek idatzi *dionetik* Ainhoari gutuna...
 Since Asier has written a letter to Ainhoa
- (102) a. Asierrek Ainhoari gutuna idatz (*ez*) *diezaion*...
 -E -D letter write (no) aux-comp
 (So) that Asier (not) write (subj) a letter to Ainhoa
 b. *Asierrek *ez diezaion* Ainhoari gutuna idatz...
 (So) that Asier not write a letter to Ainhoa
 c. *Asierrek idatz *diezaion* Ainhoari gutuna...
 (So) that Asier write a letter to Ainhoa
- (103) a. Asierrek Ainhoari gutunak idaz-te-n (*ez*) *dizkionez*...
 -E -D letters write-TE-loc (not) aux-comp
 Because/since Asier does (not) write letters to Ainhoa
 b. *Asierrek *ez dizkionez* Ainhoari gutunak idazten...
 Because/since Asier does not write letters to Ainhoa
 c. *Asierrek idazten *dizkionez* Ainhoari gutunak...
 Because/since Asier writes letters to Ainhoa

As can be observed, the negative element moves along with the inflected verb to the complementizer position. Interestingly enough, when these subordinate sentences have empty (pronominal) subjects and objects and the inflected verb stands alone, no ungrammaticality results. This contrasts with the situation in root-clauses (e.g. (98) above, repeated here as (104a) for convenience):

- (104) a. *dator (Ainhoa)... 'is coming (Ainhoa)...'
 b. *dakit (gauza bat)... 'I know (a thing) ...'

- (105) a. datorrean, Ainhoa deitu egi-n-go gaitu
comes-comp -E call do-perf-KO has
When she arrives, Ainhoa will call
b. dakidan gauza bakararra...
know-comp thing only-art
The only thing I know

The contrast is nicely predicted by the analysis whereby INFL moves to COMP in these subordinate clauses and hence need not assign its f-feature to an overt element in spec(I); in (104a) and (104b), on the other hand, *dator* and *dakit* are standing in INFL but assign no f-feature in violation of the Principle of Functional Feature Assignment. An interesting question arises when we look at the situation of embedded sentences that are complements to verbs of thinking and saying (generally formed with the complementizer *la* 'that'); these subordinate sentences behave precisely like root sentences in that operator-like elements are sentence-initial (in the "left position") and have the inflected verb immediately following them together with the complementizer:

- (106) a. Asierrek [*ez datorrela* Ainhoa etxera] esan du
-E not comes-comp home say-perf has
Asier has said that Ainhoa is not coming home
b. Asierrek [*ba datorrela* Ainhoa] esan du
aff comes-comp say-perf has
Asier has said that Ainhoa IS coming home
c. *Asierrek [*datorrela* Ainhoa etxera] esan du²⁹
comes-comp Ainhoa home say-perf has
Asier has said that Ainhoa is coming home
d. *Nondik_i* dio Asierrek [*t_i datorrela* Ainhoa *t_i*] ?
where-abl says -E comes-that
Where does Asier say that Ainhoa is coming from?

The contrast between (106a,b) and (106c) indicate that these sentential complements are indeed root-like in that INFL must assign its f-feature to an operator-like element (cf. Emonds 1976: chapter two and references therein). If the operator is [+wh] then it must move to a higher spec(I), but the embedded verb is still second with respect to the extracted element³⁰.

What is problematic in these embedded sentences which display root-clause behavior is the presence of the complementizer on the verb in second-position. What I would like to propose here is that the COMP position is allowed to remain empty in these cases, because its alternative realization on the head INFL is licensed by the *Invisible Category Principle* of Emonds' (1985, 1987):

(29) Sentence (105c) is ok as an indirect imperative; note that imperatives, as opposed to regular inflected verbs, are also possible sentence-initially: *betor* 'that s/he come', *zatoz bona* '(You-sg) come here'. Perhaps, some imperative element stands in spec(I) (cf. Katz & Postal 1964).

(30) Pied-piping of the entire clause is also possible (cf. Ortiz de Urbina 1989).

- (107) *Invisible Category Principle*: A closed category B with positively specified features C_i may remain empty throughout a syntactic derivation if the features C_i (save possibly B itself) are all alternatively realized in a phrasal sister of B.
- (108) *Alternative Realization*: A feature C of a closed category B is alternatively realized in a sister D of B if and only if B appears in the surface configuration $[B, +C] D[... C_i ...]$ and no maximal projection within D contains C_i (Emonds 1987: 615).

In Emonds' account, the ICP allows for the possibility of the Determiner's remaining empty when the feature [+plural] is realized on the head of NP; for the possibility of spec(A) to remain empty when comparative *er* is realized on the adjective (rather than as *more*); and for the existence of adverbial DPs with empty prepositions.

Because of the properties of the functional category INFL in Basque root clauses, features that are generally associated with COMP (= [α wh, β operator], [raffective]) in other languages are in fact productively realized on IP (its specifier and/or its head). Since IP is a sister of COMP, the ICP will license an empty COMP position alternatively realized on INFL³¹:

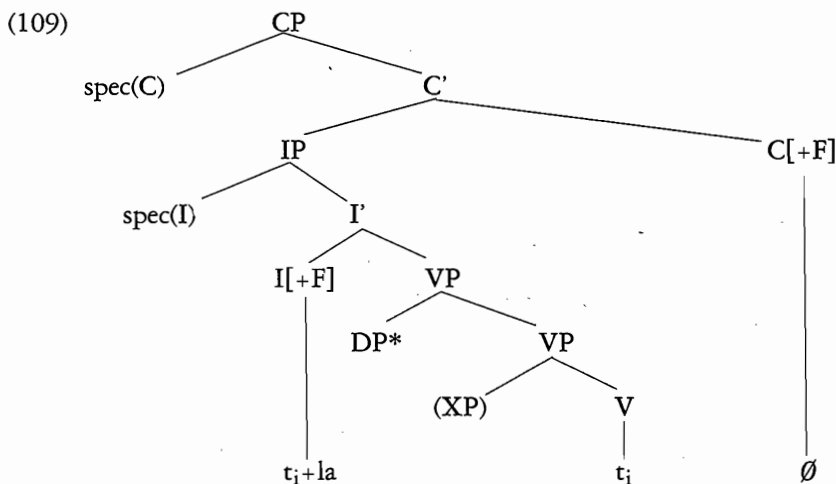

Put differently, the complementizer may be realized on INFL because INFL may productively bear or assign the features associated with COMP. If INFL doesn't agree with an operator element in an embedded sentence, then INFL must move to COMP because complementizers are bound morphemes. The situation is exactly the same with the [+wh] complementizer *n*; if there is an overt INFL element, the complementizer *n* is realized on INFL:

(31) The ICP account is akin to de Rijk's (1969: 331) suggestion that "*la* is stuck in by a late postcyclic rule". A similar proposal (though slightly different in spirit) is made in Ortiz de Urbina (1989b), who suggests that *la* is semantically "empty" and is perhaps lowered onto INFL.

- (110) a. *Gurasoek [*nor* Dimara *joa-n-go den* oporretan] galde-tu dute
 parents-E who Dima-adl go-perf-KO is-comp vacation-loc aske-perf have
 The parents asked who will go to Dima on vacation
 b. Gurasoek [*nor joa-n-go den* Dimara oporretan] galde-tu dute

Nonetheless, the *wh*-phrase must raise to *spec*(C) from *spec*(I) for the subcategorization requirements of [+*wh*] verbs to be satisfied; I assume that this is the case in (110b) and the like. The complementizer itself, however, is realized on INFL:

- (111) Gurasoek [CP *nor*_i [IP *t*_i [I *joango den*] Dimara oporretan]] galde-tu dute

1.3.5. Other analyses of word order

The proposal I have made here is intended to contribute to the solution of the word order issue in Basque. Although it is not without problems, it preserves the insights of traditional grammarians and, especially, the insights of Ortiz de Urbina's (1989) analysis. Ortiz de Urbina's (1989) insightful discussion of Basque word order presupposes that all heads are final in Basque, but that COMP is initial:

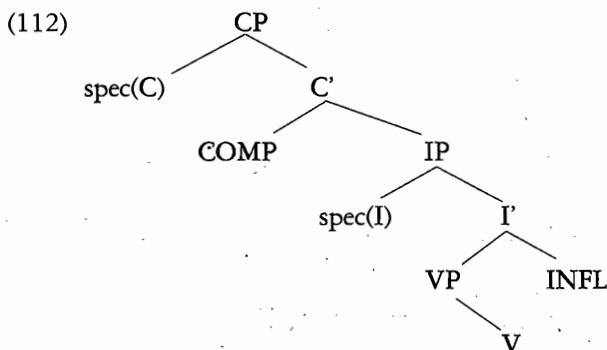

The major advantage of Ortiz de Urbina's proposal³² is that 63 operator-verb sequences are analyzed as V-2 phenomena of the kind found in many languages (Germanic and Romance) and that the existence of an additional preverbal Focus position (besides COMP) is rendered unnecessary (cf. Eguzkitza 1986, Horvath 1986). The major drawback of his proposal, however, is that Ortiz de Urbina has to assume that every instance of a sentence-final complementizer is a result of downward movement of the latter to INFL. In the case of sentence-initial operator-verb sequences (i.e. sentential complements to verbs of saying/thinking), the complementizer is moved to INFL and the entire [INFL-COMP] sequence is moved back to the COMP node. My proposal, on the other hand, retains the notion that COMP is head-final like most heads in Basque, but ascribes the fairly "unstructured" and unconstrained

(32) See Ortiz de Urbina (forthcoming) for an updated version of his account of *wh*- and focus movement within the minimalist program.

word-order to the effect produced by a head-initial INFL. I do not doubt that this may have historically arisen due to the pressure of the neighboring Indo-European languages³³.

Laka's (1990) insights too are retained under my proposal without the problems inherent to her analysis. She proposes a sentence-initial Σ projection where the functional negative and affirmative/emphatic heads are generated. She assumes that focused phrases move to $\text{spec}(\Sigma)$:

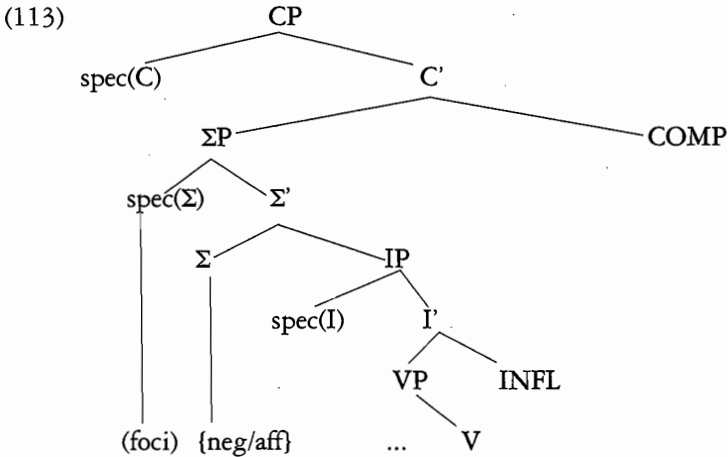

The main problem with Laka's analysis is that wh-phrases are left out of the discussion and the parallelism between foci/negation and wh-phrases is not captured in a unified way. Her analysis also predicts that the unmarked word order in negative sentences is negation + (auxiliary) verb + subject, when in fact the subject generally precedes the negative element. A second problem in Laka's proposal is that no account is given for the fact that some (but not all) embedded sentences behave like root sentences.

1.3.6. Case in Basque

Basque is a morphologically ergative language. By morphologically ergative I mean that the subject of transitive verbs (regardless of the θ -role they receive) and the subject of unergative verbs in the sense of Burzio (1986) bear the marker *k*.

(33) No doubt, the hypothesis that the irregular order of a head in Basque is caused by the neighboring languages is consistent with the notion that CP is its only head-initial category, as Ortiz de Urbina proposes. In Old Basque, we find some examples of argumental wh-phrases that are not adjacent to the verb; this is expected if movement is to $\text{spec}(I)$ or $\text{spec}(C)$ and both I and C are final:

- i. Zer adorazione-mota hemen kondenatzen da?
- what adoration-kind here condemn-TE-loc is

 What kind of adoration is condemned here? (Leizarraga, XVIth century writer)

These sentences usually involve rhetorical questions in literary texts, whose status as sentences representative of the grammar (even of speakers of that time) is dubious (Leizarraga is well-known to have intended to write in an archaic style). Therefore, these sentences do not necessarily imply that Basque was INFL-final (or COMP-final in O. de U.'s terms) at a given time.

Subjects of unaccusatives and objects of transitive verbs have no morphological mark at all:

(114) *Unergatives*

Ainhoa-k gogor burruka-tze-n du
 -E hard fight-TE-loc has
 Ainhoa fights hard

(115) *Transitives*

<p>a. Ainhoa-k Asier maite du -E love has Ainhoa loves Asier</p>	<p>b. Labana-k gutunazala ebak-i du knife-E envelop cut-perf has The knife has cut the envelop</p>
--	--

(116) *Unaccusatives*

Gutuna berandu hel-du da
 letter late arrive-perf is
 The letter has arrived late

The ergative marker seems to indicate that certain DPs are external arguments in their D-S position; at S-S no syntactic difference exists between subjects of unaccusatives and subjects of transitives/unergatives³⁴. I will assume therefore that the ergative marker is just a reflection of a language specific rule inserting the affix *k* under Koopman & Sportiche's DP* position if the latter is lexically filled:

- (117) $\emptyset \rightarrow K$, D, /+D__
 If D is lexical, and D is in [DP*, VP]

I take the position that INFL in Basque assigns governed (nominative) case to the DP* position at S-S; in the case of unaccusative verbs, the D-S object raises to DP* to receive governed case from INFL. I thus assign no particular case-theoretic status to the ergative morpheme. Put differently, I dissociate abstract case from morphological ergativity. Another alternative is to assume that INFL may assign case to the DP* position at D-S or at S-S. If it assigns it at D-S, then the noun phrase occupying the DP* position will be marked by the "ergative" affix. If the D-S object of an unaccusative verb moves to the DP* position at S-S, then INFL will also assign governed case to it but without a morphological reflex on the noun phrase. I will not adopt this position here but keep it as a possibility³⁵.

(34) See Ortiz de Urbina (1989) for arguments: these have to do with control, the position of negation, etc. Ortiz de Urbina shows that a treatment of unaccusatives *à la* Burzio —coindexation with a pronominal element in spec(I)— is untenable in Basque.

(35) See Oyharçabal (1992) for a proposal that the ergative is an inherent case. My assumptions agree with O. de U. in that INFL is responsible for case-marking of subjects in both situations ("ergative" and "absolutive"). But I depart from his view that Basque INFL may assign ergative, absolutive and dative indistinctively. For a more updated version of case theory as it applies to Basque, see Laka (1993).

2. The roots of nominalization in Basque

The grammatical formative *te* (and its variant *tze*) has long been regarded as “nominal in nature” in the Basque linguistic literature (Lafitte 1962); it shows up in three different constructions, summarized in (1):

- (1) a. [Euskaldunen alfabetatze masiboak] ere ez luke hizkuntzaren
 Basque-gen alphabetize-TE massive-E even no aux language-gen
 etorkizuna ziurtatuko
 future assure
 Even a/the massive alphabetization of Basque speakers would not
 secure the future of the language
- b. [(Herri batek) hiritarrak alfabetatze-a] funtsezkoa da
 country one-E citizens TE-art fundamental is
 A given country's alphabetizing its citizens is fundamental
- c. Ainhoa oporretan Lekeitiora joa-te-n da/zen
 vacation-loc Lekeitio-adl go-TE-loc is/was
 Ainhoa goes/used to go to Lekeitio on vacation

In (1a) *te* forms a derived nominal; in (1b) the bracketed structure corresponds to a nominalized (tenseless) clause, a notion which will be clarified below and which constitutes the core of this chapter; in (1c) *te*, together with the locative postposition *n*, is used as an aspect marker for imperfect (i.e. [-completed]) tenses. I will argue in chapter four that this third use of *te* reduces to the second one (i.e. that there is no Aspect Phrase), but I leave it out of the discussion for the time being.

The main idea of this chapter is to show that the theory of grammar can (and furthermore must) capture the intuition that *te* is indeed a morpheme of category N in both instances (1a and 1b) if it is indeed to attain a deep understanding of the interaction between morphology and syntax. In this light, I adopt and further investigate the *Double Lexical Insertion Level Hypothesis* presented in chapter one: grammatical formatives are inserted at D-S when some purely semantic feature conditions lexical insertion; otherwise, they are inserted after S-S. It is claimed here that in UG late insertion of a nominalizing suffix gives rise to a maximal projection headed by a nominal element which is “switched off” until PF and allows the entire phrase to behave as a clause internally. More specifically, I propose that *te* is uniformly a morpheme of category N, which bears the syntactic feature [-completed] when it is inserted in the context V___ after S-S. I will try to show that this, interpreted in the light of the DP hypothesis, accounts for the possibility of assigning abstract case to the subject in (1b) as a result of V-N to D movement, a situation that mirrors movement in clauses (V-to-I movement). Since this movement is impossible in English gerunds for independent reasons, it follows that the only case available for the subject will be genitive¹.

(1) ACC-*ing* seems to be a purely stylistic variant of POSS-*ing* for many speakers, according to Emonds (but see footnote 3).

I have organized the discussion as follows. Section 2.1 refines Emonds's treatment of English nominal *ing*, in terms of the DP hypothesis; several theoretical and empirical advantages over Abney's (1987) and Suzuki's (1988) analyses are examined. Section 2.2 discusses briefly the use of *te* as a suffix forming derived nominals. Section 2.3 argues against previous analyses of Basque nominalized clauses of the type shown in (1b), which considered them CPs, and proposes several tests that show that these constituents are indeed noun phrases in the traditional sense. Section 2.4 develops an analysis of Basque nominalized clauses as DPs with a nominal head (*te*), subject to late lexical insertion. Abstract case-marking of the subject DP is shown to be dependent on the possibility of V-N to D movement. Section 2.5 argues that the apparent clausal properties of nominalized clauses are compatible with their being dominated by a DP node. Finally, the case of the Spanish nominal infinitives discussed in Plann (1981) is brought into the discussion in 2.6 as another example of the double insertion nature of grammatical formatives. Variation in the extraction possibilities out of "clausal" DPs in Basque/English and Spanish are accounted for in terms of the *Empty Category Principle*, which I assume applies at PF (cf. Aoun et al. 1987).

2.1. A DP analysis of English NP-gerunds

As was pointed out in chapter one (1.2.2.1), Emonds (1990) has proposed that the dual nature of nominal *ing* in English stems from the hypothesis that grammatical formatives may be inserted at D-S or after S-S otherwise (in which case they are not visible until PF). This dichotomy makes it possible to maintain that both instances of the morpheme are basically the same, i.e. that the morpheme is of category N, +V___, in both the "syntactic" and the derivational uses, as expressed by the lexical entry in (4):

- (2) a. The shooting of the lions by the hunters
 b. My handling of the problem
 c. *Your knowing of algebra surprised me
 d. *The amusing of people is fatiguing
- (3) a. (The hunters') shooting the lions upset all of us
 b. Nobody objected to my handling the problem
 c. Your knowing algebra surprised me
 d. Amusing people is fatiguing
- (4) *ing*], N, +V___ (N: V= +ACTIVITY)

The parenthesized option in (4) forces the affix to be restricted to a semantic subclass of verbs which will result in its being inserted at D-S; no such restriction exists if the affix is by default inserted after S-S. Emonds (1990) further claims that the feature +V and the late insertion option of nominal *ing* induce a full NP structure as constrained by X-Bar theory whose nominal head is in fact null,

“switched off”, until PF, thus allowing the verb to act as the L-head of the phrase, so defined in (6):

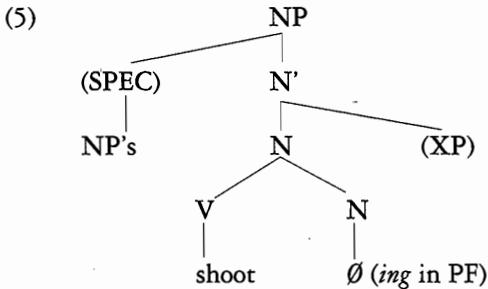

- (6) The L(exical)-head of Y^2 is the rightmost lexically filled X^0 dominated by Y^2 (and by no other phrasal projection under Y^2)

By (6), the verb is the L-head of the NP at both D-S and S- S; the verb selects all the complements inside NP and is able to assign case to an NP of which it constitutes a sister (cf. ch. one: 1.2.3), so the internal sentence-like behavior of the phrase follows from this. Henceforth I propose to recast the proposal in (5) in terms of the DP hypothesis (Fukui & Speas 1986); as in chapter one, I assume that *all categories* project to the double bar level:

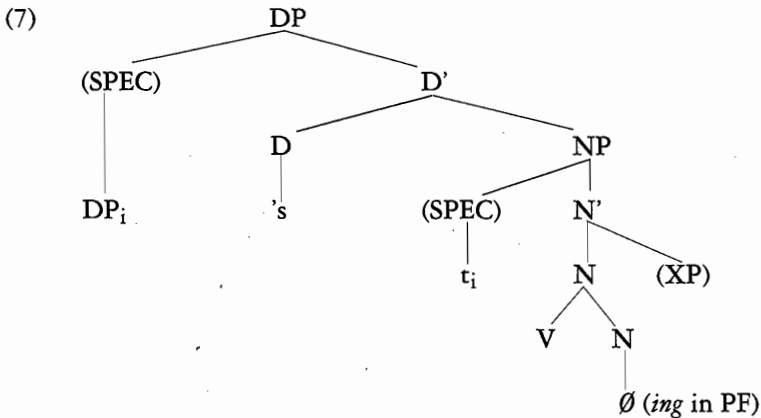

Following Mallén (1989), Suzuki (1988) and Torrego (1987), I assume that DP subjects originate (in the specifier position) inside NP. This claim is parallel to the notion that IP subjects originate inside VP (cf. Zagona 1982, Koopman & Sportiche 1991 and others)². In line with Koopman & Sportiche (1991), I also assume that DET in English is a raising category (like INFL), and that the DP subject moves to spec(D) for case reasons: it receives case from DET ('s) by agreement. If 's is absent,

(2) Koopman & Sportiche (1991) do not decide whether the DP* subject position inside VP is the actual specifier position or an adjunction structure. I retain that ambiguity here. Nevertheless, I do assume that the NP internal subject is the spec(N) position.

PRO stays in the spec(N) position and remains ungoverned: an empty (contentless) DET cannot govern into spec(N)³. The absence of a lexical DET eliminates the minimality effect over V (cf. Rizzi 1990) and therefore V inside NP in (7) could head-govern spec(N) since it m-commands it by *Empty Head Transparency*; nevertheless, this is avoided because head-government in English is from left to right.

The structure in (7), to which I will refer as the *Nominal Head hypothesis*, is reminiscent of recent proposals to analyze nominal gerunds advanced by Abney (1987) and Suzuki (1988):

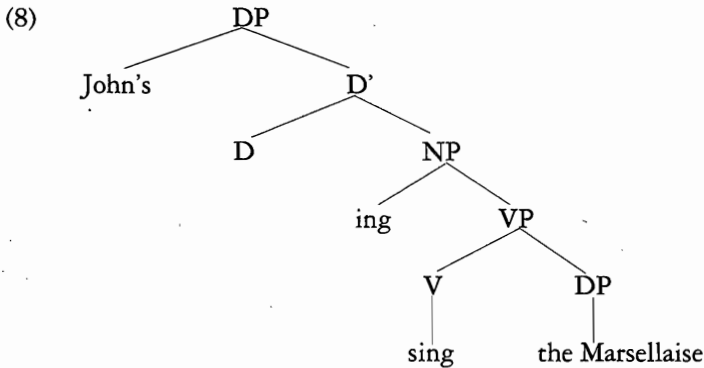

Abney (1987: 223)

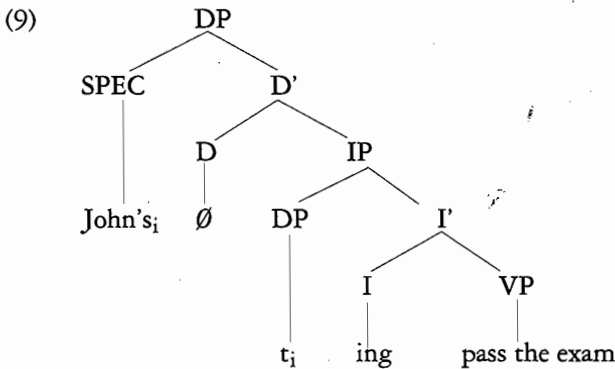

(=John's passing the exam) Suzuki (1988: 119)

(3) I regard POSS-*ing* and PRO-*ing* as instances of (7), which I will call DP-gerund [the latter being the subjectless case of the former], since they both have the same external distribution (Emonds 1976, Abney 1987). As for ACC-*ing*, some authors suggest that it behaves differently from DP-gerunds even with respect to distributional tests (Reuland 1983, Abney 1987). Emonds (1992), on the other hand, argues that the different properties attributed to the ACC-*ing* construction (free extraction, anaphor subjects) are a reflection of the fact that the sequence of an accusative noun phrase and a gerund doesn't always form a constituent and is in many cases a sequence of two complements (DP and AP-gerund) just like in the case of perception verbs. Where this is not the case, both POSS-*ing* and ACC-*ing* behave alike:

- i. * My parents are investigating each other (s) buying a house
- ii. * What are your parents investigating John(s) buying ?

In (9), movement of the DP subject to spec(D) is triggered by Suzuki's *Definiteness Principle*, which requires all [+definite] DPs (among which he includes DP-gerunds) to have some [+definite] element in spec(D) or DET at S-S. In Suzuki's account, a [+Nominal] INFL can assign genitive case to its specifier.

The nominal head hypothesis in (7) differs from Abney's and Suzuki's proposals in fundamental ways and, theoretical matters aside⁴, it also makes a different set of predictions. In the following paragraphs, I briefly summarize these differences with respect to the absence of a spec(V) position, the absence of gapping and null VP effects, and the lack of NP ellipsis (standard N' deletion). The data will show that only the nominal head hypothesis can predict all these characteristics of DP-gerunds. First of all, the Nominal Head hypothesis represented by (7) predicts that only specifiers of DET should be allowed inside DP-gerunds, as is the case (cf. Abney 1987 and Suzuki 1988, who include demonstratives, negative 'no', and the article in Old English). Crucially the proposal in (7), unlike Abney's or Suzuki's, also predicts that no specifier of VP should be licensed since there is no VP proper. Zagona (1988a: ch.2) has independently shown that the *scarcely* type of adverbials are generated under the spec(V) position. If she is right, they should not be able to occur in DP-gerunds. This prediction is confirmed by all the speakers I have consulted with:

- (10) a. We all object to the university's (*? hardly) hiring female professors
 b. The teacher was shocked by Mary's (*? hardly/barely) answering a question right
 c. Lisa's (*? barely/scarcely) drinking beer surprises her friends

Second, gapping of the verb alone in English usually contrasts with gapping of the verb associated with INFL:

- (11) a. Max played the drums and Charlie the alto sax
 b. Max could play the drums and Charlie the alto sax
 c. ?? Max could play the drums and Charlie could the alto sax
 [d. * Max could play the drums and Charlie play the alto sax]

Under Suzuki's analysis, gapping of V-*ing* in DP-gerunds should pattern with (11a/b) if *ing* is indeed INFL; under (7), it should pattern together with (11c), where V alone is gapped (no INFL element is involved). The data indicate the correctness of (7)'s predictions:

- (12) a. ?? I enjoy Max's playing the drums and Charlie's the alto sax
 b. *? I object to Mary's writing the first part and Joe's the second
 c. *? Sharon's teaching syntax and Joe's phonology came as a surprise
 [cf. d. I expected Sharon to teach phonology and Joe syntax]

(4) These are not trivial in any case. And I will return to them in section 2.2.1. Note that licensing VP as complement to an affix which lacks categorial status is unusual from the point of view of UG; the same can be said of the ability of the "lexical features" of *ing* to transform VP into NP (cf. Abney 1987). Equally problematic is the licensing of IP as complement to DET. Both authors fail to characterize in a systematic way what is common to both nominal *ings* (derivational vs syntactic), and hence to predict why DP-gerunds should have a noun phrase distribution in the first place.

As (12d) illustrates, gapping of a verb and a non-finite INFL is grammatical, which goes to prove that the marginality of (12a-c) cannot be attributed to the non-finiteness of inflectional *ing*. The data on gapping thus favors Emonds' analysis over Suzuki's (the argument is neutral with respect to Abney's account). A third argument which also favors the Nominal Head hypothesis account over Suzuki's analysis (but is neutral with regard to Abney's proposal) is provided by the absence of VP-ellipsis in DP-gerunds. Lobeck (1986) and Zagona (1988a, b) have shown that a non-finite INFL can only properly govern a null VP if the CP immediately containing it is an argument:

- (13) a. John persuaded Mary to leave, and Fred persuaded Mary to [vp \emptyset]
 b. * John runs to stay fit, and Bill swims to [vp \emptyset] (Zagona 1988a: 94)

Zagona derives this contrast by requiring that null VPs be Tense-governed, and by assuming that non-finite INFL can only become a Tense-governor if it is immediately contained in an argument. Unlike *to*, a head like *ing*, if it is indeed INFL as Suzuki proposes, cannot be a proper governor by itself because it requires affixation of a verb, a process which destroys the context for null VPs. Nevertheless, according to Zagona (1988b: 114), auxiliaries in argument non-finite clauses may properly govern a null VP if they are coindexed with their non-finite INFL:

- (14) a. (?) John might not want to have graduated soon, but Phil would like to have [vp \emptyset]
 b. (?) John might not want to be studying tonight, but Phil would love to be [vp \emptyset]

The auxiliary verbs *have* and *be* in (14) properly govern a null VP because they can be coindexed their non-finite INFL (*to*) (no barrier intervenes). Similar judgments should obtain with *have-ing* (V-I) under Suzuki's analysis if *ing* is indeed INFL provided the gerund is an argument. The prediction is not confirmed:

- (15) a. * Some people don't regret having gone to the movie but John regrets having [vp \emptyset]
 b. * Bird enjoyed having played with Miles and Trane enjoyed having [vp \emptyset], too

Nothing prevents Zagona's INFL-auxiliary coindexing from taking place in (15a, b); therefore Suzuki's analysis predicts that (15) should be grammatical. The failure of the auxiliaries to properly govern the null VP in (15), on the other hand, follows from (7), since no INFL node is present. Finally, the absence of NP ellipsis in DP-gerunds favors the Nominal Head account over Abney's proposal. Consider the following sentences:

- (16) a. *I like Mary's singing the blues but I prefer Bessie Smith's [NP \emptyset]
 b. *I was surprised by John's pitching in, and by Mary's [NP \emptyset] too (Abney's 1987: 200b)

- (17) a. I like Maria's car but I prefer Perry's [NP \emptyset]
 b. I was surprised by John's eagerness, and by Mary's [NP \emptyset] too
 (Abney's 200a)
 c. Mary's examination of the papers lasted one hour, but Joe's [NP \emptyset]
 lasted just a few minutes
 d. Mary's defense of the proposal came as a surprise but Joe's [NP \emptyset]
 was expected

The contrast between (16) and (17) shows that NP ellipsis (standard N' deletion) is not possible with DP-gerunds even though it is grammatical with regular DPs. This seems unproblematic for Suzuki's analysis; the ungrammaticality of (16) can be attributed to the failure of the genitive subject to receive case from INFL, since the latter is missing. Abney, however, has no explanation to offer for the contrast. Contrary to Abney's claim, the absence of NP ellipsis in DP-gerunds cannot be due to the fact that event/fact nominals (among which DP-gerunds are certainly included) disallow NP ellipsis in general, since (17c/d) are grammatical⁵. Under the Nominal Head hypothesis, there is a very straightforward account of the contrast between (16)-(17).

Let us assume, as in Williams (1977), that null NPs are base-generated. Following Lobeck (1986, 1991), I assume that a null NP must obey the ECP and is licensed as an empty category because it is properly governed by 's in DET (at PF in my terms). Like all elements in a syntactic representation, a null NP must be interpreted (cf. Chomsky's 1986a *Principle of Full Interpretation*). According to Williams (1977), this is done via an interpretive rule (i.e. his *Delta-Sub-f Interpretation rule*) which copies some previous NP in the sentence/discourse in order to assign the relevant interpretation to an ellipsed NP and applies to LF representations. This rule (which crucially has no access to PF, the level at which the nominal head *ing* is inserted) will fail to provide the ellipsed NP with an appropriate interpretation on the assumption that the copied NP lacks a nominal head proper⁶.

The preceding four characteristics of DP-gerunds are all predicted by the Nominal Head hypothesis in (7), but not by Suzuki's and Abney's proposals, which fail to predict at least two of them. In view of this, I conclude that the Nominal Head hypothesis for DP-gerunds is to be preferred. Its predictive power thus constitutes further evidence for the correctness of the late lexical insertion mechanism advocated by Emonds (1985, 1990) for English *ing*. I now turn to the analysis of the Basque morpheme *te* in its derivational use.

(5) Not surprisingly, Grimshaw (1990: ch.2) does not mention N'-deletion among the numerous tests distinguishing complex event nominals from result nominals, which roughly corresponds to Abney's fact/act nominals distinction.

(6) Although I have referred to the paradigm in (16)-(17) as *NP ellipsis*, the argument in favor of the Nominal Head hypothesis is independent of whether these empty NPs are actually base-generated or deleted by *affect*. If this second approach is taken, the argument can be formulated along the following lines: Let us trivially suppose that in order for *affect* α Chomsky 1991) to apply (at S-S), α must be present in the representation; this is uncontroversial. Let us further assume that in order for α , $\alpha=XP$, to be present, the head of α must be present (=X). Since the nominal head in (16) is in fact absent, it follows that deletion cannot proceed to the extent that the head of N is absent until PF [crucially *affect* α does not affect the PF component].

2.2. *te* in derived nominals

In this section I simply outline the characteristics of nominals derived from *te* which are relevant for the discussion here and which illustrate the true nominal character of these nouns. I have heavily relied on Goenaga's (1984) and Ortiz de Urbina's (1989) works on the subject, as well as on Eguzkitza's (1992) general discussion on DPs in Basque. The second part of this section is devoted to showing that *te* derivation is in fact restricted to a semantic class that I will tentatively characterize as [+ACTIVITY].

2.2.1. *Properties*

a. The noun phrase status of *te*-derived nominals is indisputable. First, the internal structure of these nominals parallels that of other derived nominals and regular noun phrases. Both subjects and objects appear in the genitive case:

- (18) a. Ainhoa-ren argazkia (picture noun)
 gen photo
 The/a picture of Ainhoa
 b. Ainhoa-ren etorrera (derived noun)
 arrival
 Ainhoa's arrival
 c. Ainhoa-ren *etortzea* (*te* derived noun)
 Ainhoa's arrival
 d. Berebila-ren erreketeta (derived noun)
 car-gen burning
 The burning of the/a car
 e. Berebila-ren *erretzea* (*te* derived noun)
 The burning of the/a car

According to Eguzkitza (1992), both subject and object genitives can occur inside DPs. This is also possible in *te*-derived nominals:

- (19) Manifestatzaileen berebilaren erreketeta/ *erretzea*
 demonstratros-gen car-gen burning / burn-TE-art
 The demonstrators's burning of the/a car

b. *te*-derived nominals may also be modified by adjectives:

- (20) Ainhoa-ren ibiltze azkar hori itzel gustatzen zait
 -gen walk-TE quick that terrible like aux
 I like a lot that quick walking of Ainhoa's

c. Like in regular nominals, any PP modifier (whether complement or adjunct) must take the postposition *ko* in order to occur as a DP internal element (cf. de Rijk 1988, who analyzes *ko* as an adjective forming suffix)⁷:

(7) There are some apparent counterexamples to this, with some adjuncts and adverbs, as noted by Goenaga (1984). They are apparent, because they involve composition:

- (21) a. Ainhoa-ren gaurko *etortzea* / *etorrera*
 -gen today-KO come-TE-art arrival
 Ainhoa's arrival "of" today
 b. Ainhoa gaur dator
 Ainhoa arrives today

d. Like regular nouns, nominals derived from *te* can be relativized (cf. Goenaga 1984) yielding a result reading:

- (22) Aitonari gustatzen zaion gidatze azkarra Alemanian ikusten da
 grandpa-D like aux-comp driving fast Germany-loc see aux
 (adapted from Goenaga 1984)
 The fast driving that grandpa likes can be seen in Germany

e. As noted by Goenaga (1984), and contrary to the situation in tensed clauses, scrambling of internal arguments within *te*-derived nominals and noun phrases in general is ungrammatical and the order is rather fixed:

- (23) a. Ainhoa gaur etxera dator c. Gaur dator Ainhoa etxera
 today home-adl comes d. ...
 b. Ainhoa dator gaur etxera "Ainhoa comes home today"
- (24) a. Ainhoa-ren gaurko etxerako *etortzea*/ *etorrera*
 -gen today-KO home-adl-KO come-TE-art/ arrival
 b. * Ainhoa-ren *etortzea*/ *etorrera* gaurko etxerako
 c. * Gaurko *etortzea*/ *etorrera* Ainhoaren etxerako⁸
 d. * ...
 "Ainhoa's coming/arrival "of to home" "of today"

- i. Gurasoen Ondarrura-joatea [hyphen X.A.] Parents' Ondarroa-going
 ii. Gurasoen ongi-izatea [hyphen X.A.] Parents' well-being

As for (i), the fact that Basque P(ositions) are bound morphemes entails that any P-V or P-N compound looks like PP-V or PP-N on the surface (cf. chapter one 1.2.2.1). That (i) is a compound can be shown because the (i) becomes ungrammatical if more than a single word is used for the P element:

- iii. *? Gurasoen etxe berrira-joatea Parents' new house-going

Crucially, *ondarrura* does not have referential value in (i) (this test is taken from Williams & DiSciullo 1987); (iv) is not a contradictory statement whereas (v), with a nominalized clause where *Ondarrura* is a PP, is:

- iv. Nekatuta nago gurasoen Ondarrura-joatearekin, Ondarrura sekula joan ez badira ere
 I'm tired of (my) parents' Ondarroa-going, although they've never gone to Ondarroa
 v. (!) Nekatuta nago gurasoak Ondarrura joatearekin, Ondarrura sekula joan ez badira ere
 I'm tired of my parents' going to Ondarroa, although they've never gone to Ondarroa

Finally, Goenaga himself gives one further argument: no wh-phrase can replace *Ondarrura* in (i), a result expected if it is indeed a member of a compound (and hence lacks referential value):

- vi. Gurasoen nora-joatea da berri ona? Parents' where-going is good news?

Similar considerations apply to (ii).

(8) Eguzkitza (1992) notes that in some cases an object may precede the subject:

- i. Cortazar-en Poe-ren itzulpena Cortazar's translation of Poe
 ii. Poe-ren Cortazar-en itzulpena Poe's translation by Cortazar

In (ii) the implication is that there is more than one translation other than Cortazar's. In any case, it seems that any further scrambling/movement beyond the object's moving to spec(D) is not possible. Thus, Goenaga's generalization is still valid to a large extent.

f. Extraction of any internal arguments from *te*-derived nominals and Basque DPs in general is impossible, most likely because they violate Ross's (1969) Left Branch Condition (or, ultimately the ECP)⁹:

- (25) a. *Noren espero du aitak [t etortzea] ?
 whose expect aux father-E come-TE-art
 Whose does father expect [t coming/arriving] ?
 b. *Noren espero du aitak [t dirua] ?
 money
 Whose does father expect [t money] ?

However, the entire DP can be pied-piped to the matrix spec(C) position:

- (26) a. [Noren etortzea] espero du aitak t ?
 Whose coming/arriving does father expect ?
 b. [Noren dirua] espero du aitak t ?
 Whose money does father expect ?

In view of these six characteristics, I propose the following tree structure for *te*-derived nominals:

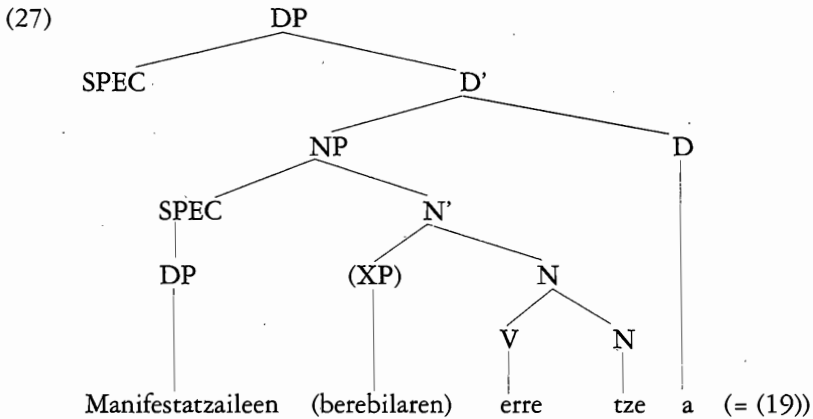

My contention is that the subject DP is assigned genitive case by DET, which, *unlike in English* (cf. (17) above), I take not to be a raising category in Basque, the same as INFL (cf. Koopman & Sportiche 1991).

2.2.2. Restrictions on *te*-derived nominals

Having outlined the main properties of *te*-derived nominals, I now take up the issue of the restriction on the verbs that may take *te*. At first sight, it appears as

(9) See Stowell (1989) for an ECP treatment of the LBC, and Suzuki (1988: 94), who reduces the LBC to the following Definiteness Principle:

- i. Definiteness Filter: a [+definite] DP must have one [+definite] element at S- \bar{S}
- ii. Definiteness-raising: every [+definite] XP must be raised to [+definite] DP at LF

though just any verb may undergo *te* suffixation, especially if a derived nominal is impossible with other suffixes, very much like *ing* in English:

- (28) a. Lagunen mendirako igoera/igotzea
 Friends-gen mountain-adl-KO climbing/climb-TE-art
 My friends's climbing of the mountain
 b. Lagunen ibilera/ ibiltzea
 walking/ walk-TE-art
 My friends's walking
 c. Arazoaren azalpena/ azaltzea
 problem-gen explanation/ explain-TE-art
 The explanation/ explaining of the problem
- (29) a. Ainhoaren * mintzapena/ mintzatzea
 -gen speaktion / speak-TE-art
 Ainhoa's "speaktion" / speaking
 b. Umeen * euskaldunketa/ euskalduntzea
 Kids-gen Basque-learn-tion/ Basque-learn-TE-ing
 The kids's Basque-"learn-tion" / Basque-learning
 c. Abioiaren *lurrarpena/ lurrartzea
 Plane-gen land-tion/ lan-TE-art
 The plane's "land-tion"/ landing

Nonetheless, when one tries to form derived nominals from stative and "psych" verbs, the results are far less felicitous:

- (30) a. * Lagunen atzoko geratzea
 Friends-gen yesterday-KO stay-TE-art
 "My friends' staying/remaining of yesterday"
 b. * Lagunen mendiko egotea
 friends-gen mountain-KO stay-TE-art
 "My friends' staying "of" at the mountain"
 (cf. Lagunen mendiko egotaldia)
 (cf. "My friends' stay-time at the mountain)
 c. * Ainhoaren igandeko aspertzea
 -gen sunday-KO get-bored-TE-art
 "Ainhoa's getting bored of Sunday"
- (31) a. * Lagunen atzoko larritzea (cf. larrialdia)
 yesterday-KO get-upset-TE-art
 "My friends' getting upset of yesterday"
 (cf. "My friends' upset-time of yesterday")
 b. ?? Umearen etengabeko beldurtzea/ikaratzea
 Kid-gen constant-KO fright/scare-TE-art
 "The constant frightening/scaring of the kid"
 c. * Zurrumuruaren gurasoen lotsatzea
 rumor-gen parents-gen embarrass-TE-art
 "The rumor's embarrassing of my parents"

Although sporadic examples of *te*-derived nominals with stative/"psych" verbs might be found, the nature of the generalization is clear: activity oriented verbs freely form derived nominals with *te*, whereas other subclasses of verbs resist them. Therefore, I propose this provisional lexical entry for *te*:

(32) *te*, N, +V___ {V = [+ACTIVITY]}

(32) simply states that *te* is morpheme of category N that attaches to verbal roots specified as activity verbs, a restriction akin to that found for English *ing* by Emonds (1990).

2.3. Nominalized clauses headed by *te*

2.3.1. Previous analyses

Based on their internal similarities to tensed clauses, Goenaga (1984) has proposed the following structure for nominalized clauses (NCs henceforth) of the type exemplified by (1b), repeated here as (33a):

- (33) a. Herri batek hiritarrak alfabetatzea funtsezkoa da
 A given country's alphabetizing its citizens is fundamental
 b. Herri batek hiritarrak alfabetatzea funtsezkoa da
 country one-E citizens alphabetize aux-comp
 That a country alphabetizes its citizens is fundamental

- (34) a. Ainhoa etxera etortzea...
 home-adl come-TE-art
 Ainhoa's coming home...

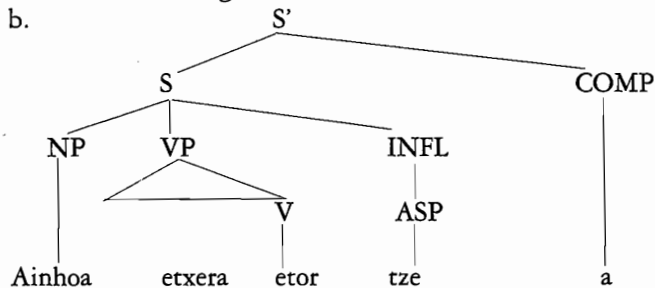

When the different postpositions (locative, ablative, ...) are attached to these NCs, he proposes that they occupy the COMP position:

- (35) a. Nik [herri batek hiritarrak *alfabetatzeari*] garrantzia ematen dio
 I-E TE-Dt importance give aux
 I give importance [to a country's alphabetizing its citizens]
 b. [Ainhoa etxera *etortzean*], denok irtengo gara
 home come-TE-loc all leave aux
 [Upon Ainhoa's coming home], we will all leave

- c. [Ainhoa etxera *etortzearekin*] ez dugu ezer konpontzen
 come-TE-with no aux anything solve
 We don't solve anything [with Ainhoa's coming home]
 d. ...

(36)

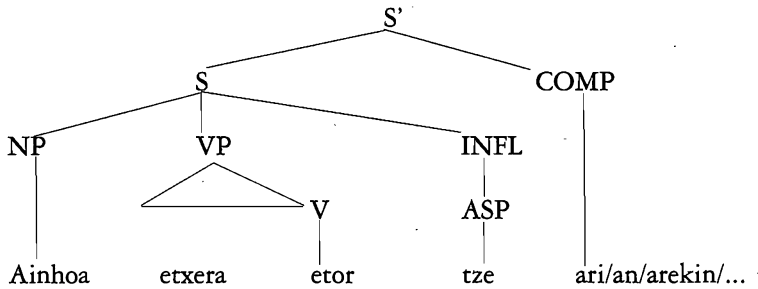

There exists in Basque a second type of NC headed by the morphemes *tu/i/n* (the choice depending on each verb), for which Goenaga proposes the exact same structure. The only difference between the two NCs is aspectual according to him: *te* is specified as [-perfect], whereas *tu/i/n* are specified as [+perfect]¹⁰:

- (37) Nik [Ainhoa etxera etorria] espero dut
 I-E home come-I-art expect aux
 "I expect [Ainhoa's having arrived home]"

(38)

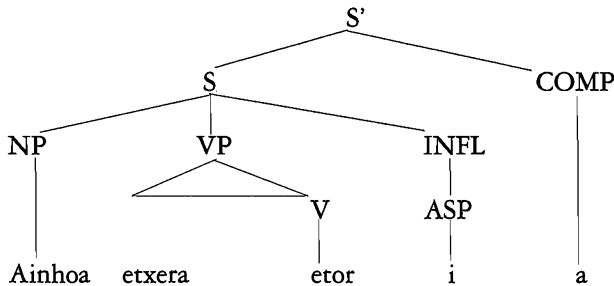

Ortiz de Urbina (1989) basically follows Goenaga's intuitions a) that NCs are indeed CPs; b) that *te* is a morpheme of category INFL; c) that the article and the relevant postpositions that attach are members of the category COMP as far as NCs are concerned (or at least they are generated under the COMP node):

(10) Goenaga argues that this difference mirrors the difference between the two morphemes when they function as aspect markers in periphrastic verb forms (cf. Arriagoitia 1991); he assumes these aspect markers originate in INFL and then cliticize onto the verb:

- i. Ainhoa etxera etor-tze-n da (= 'Ainhoa comes home')
- ii. Ainhoa etxera etorr-i da (= 'Ainhoa has come home')

Matters are more complex because *te* must also take the locative postposition N when functioning as aspect marker (a fact that Goenaga does not address). I will return to this in section 2.4 and, more extensively, in chapter four.

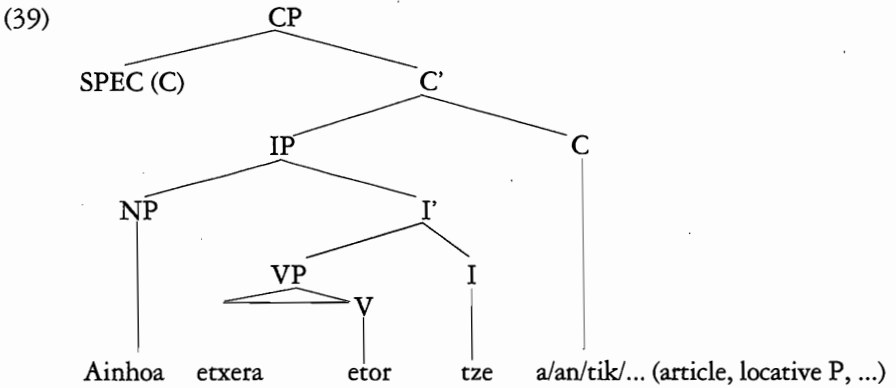

Ortiz de Urbina's analysis of NCs differs from his analysis of tensed CPs (cf. chapter one, section 1.3.5), where COMP precedes IP.

Ortiz de Urbina elaborates further on the clausal properties of NCs:

a. In contrast with *te* derived nominals (cf. (24)) and regular DPs, NCs admit scrambling of the internal elements, like tensed clauses:

- (40) a. Ainhoa gaur etxera dator (= 23) c. Etxera Ainhoa gaur dator
 today home-adl comes d. ...
 b. Gaur etxera Ainhoa dator

- (41) a. [Ainhoa gaur etxera etortzea] harrigarria da
 today home-adl come-TE-art surprising is
 b. [Gaur etxera Ainhoa etortzea] harrigarria da
 c. [Etxera Ainhoa gaur etortzea] harrigarria da
 d. *? [Gaur etortzea Ainhoa etxera] harrigarria da
 e. *? [etxera etortzea gaur Ainhoa] harrigarria da
 [Ainhoa's coming home today] is surprising

The sentences become very marginal if the scrambled phrases are to the right of the verb of the NC (cf. example (71) in chapter one); but the permutation of the elements when the verb is final is free.

b. The range of arguments and adjuncts licensed in NCs are exactly the same in NCs as in tensed CPs (and unlike in derived nominals (cf. 2.2.1.b/c above)):

- (42) a. Ainhoa gaur azkar etxera dator
 fast
 Ainhoa comes home fast today
 b. Ainhoa gaur azkar etxera etortzea
 Ainhoa's coming home fast today
 cf. c. Ainhoaren gaur-ko etxera-ko etorrera azkarr-a¹¹
 Ainhoa's fast arrival "of" at home of today

(11) The only adjectives allowed in NCs are *buts* and *soil*, which both translate as "mere, bare":

c. Wh-phrases are tolerated in NCs; NCs containing wh-elements usually pied-pipe the whole NC to a sentence initial position (matrix spec(C) in Ortiz de Urbina's analysis), a phenomenon also found in tensed clauses in Basque:

(43) [Zu nora joango zarela]_i erabaki du aitak t_i ?
 you where go aux-comp decide aux father
 "That you will go where did father decide ?"

(44) [Zu nora joatea]_i erabaki du aitak t_i ?
 go-TE-art
 "Your going where did father decide ?"

This, according to Ortiz de Urbina, constitutes evidence that NCs do indeed have a spec(C) position. I will return to this in section 2.5.

d. Following ideas developed in Raposo (1987) (and stemming from Reuland 1983), Ortiz de Urbina 1989 claims that the case-marking of the subject of NCs by non-finite INFL (i.e. by *te* in INFL) is possible a) because the IP itself is case-marked by some element in COMP (when the latter is occupied by some postposition); or b) because the entire CP is case-marked (for example when the article occupies the COMP position). Put differently, a non-finite INFL will assign case under government if it is itself governed (by a case-assigning postposition in COMP or by the article heading CP, the latter receiving case from outside). Since in the former case, the postpositions usually have DPs as sisters and presumably assign case to them, and since in the latter case NCs headed by the article can only be assigned case in the same positions as regular DPs, Ortiz de Urbina concludes that his analysis predicts that NCs (true CPs) will have the same distribution as DPs (i.e. as noun phrases), a statement which is descriptively correct:

- (45) a. [[Astelehen]_{DP}-eanP]_{pp} denok irtengo gara
 monday -loc all leave aux
 [On Monday] we will all leave
 b. [[Ainhoa etxera etor-TZE]_{IP} -[ean_{COMP}]_{CP} denok irtengo gara
 home come-TE -loc all leave aux
 [Upon Ainhoa's coming home] we will all leave
- (46) a. Asierrek [ur-[a_D]]-∅ nahi du
 -E water-art want aux
 Asier wants [(the) water]
 b. Asierrek [[Ainhoa etxera etor-TZE]_{IP} -[a_{COMP}]_{CP}] nahi du
 -E home come-TE art want aux
 "Asier wants [Ainhoa's coming home]"

i. [Ingalaterrara joate *butsak/soilak*] ez du bermatzen inglesa ondo ikastea
 "The mere going to England does not warrant learning English well"

This is an interesting restriction, also operative in Spanish nominalized infinitival clauses (cf. Plann 1981, and section 2.6), which can only be modified by the adjective *mero* "mere". I assume, with Plann, that *buts/soil* and *mero* (and possibly *solo* 'only' not discussed by her) are N-level adjectives that can modify a noun that is empty at S-S (these "grammatical" adjectives cannot be used predicatively, nor do they have any referential value).

2.3.2. Problems with previous analyses

Both Goenaga's and Ortiz de Urbina's analyses pose several problems for the theory of grammar and also face some empirical inadequacies. Their contention that NCs have internal sentential structure, although descriptively correct, dilutes any possibility of explaining in what sense these "clauses" are "nominalized" since, according to their claims, there is no nominal element. Furthermore, the alleged CP/S' status of NCs force both authors to assume that articles and contentful postpositions may have different categorial status between DET/COMP and P/COMP depending on whether they take NPs/DPs complements or a *te*-headed IP. In fact, *this latter construction is the only one which motivates this categorial duality*¹²:

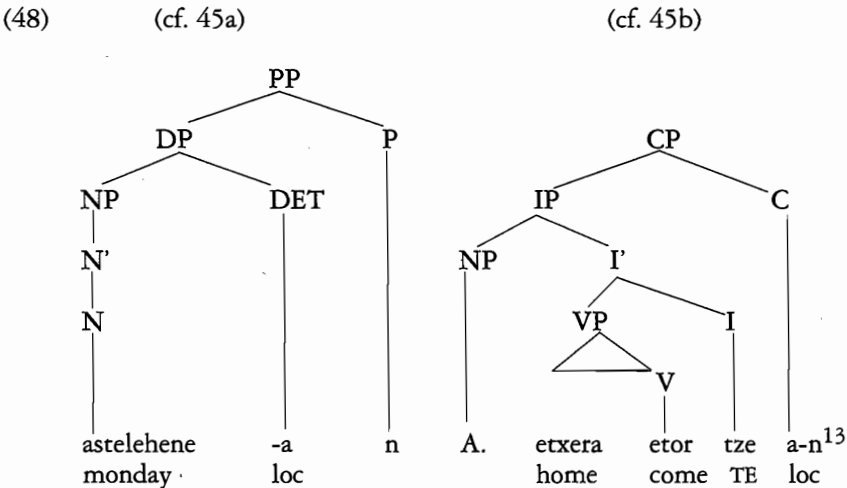
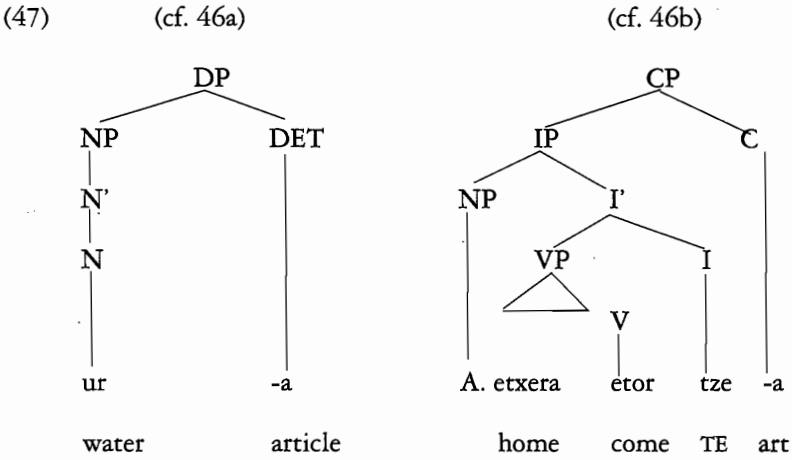

(12) Lexical items that have dual categorial status are not rare: in English *that* (COM and DET), and *to* (P and INFL) are good examples. Nonetheless, unlike the case at hand, the totally different complement system in either case warrants their duality: *that* has an IP or NP sister, and *to* takes DP or VP depending on the categorial status.

This redundancy is indeed suspect and it simply reveals the failure to properly characterize *te* as a nominal element also when it occurs in NCs.

A second theory-internal objection to Ortiz de Urbina's (and Raposo's) proposal has to do with the case-assignment mechanism they propose. It is not clear why INFL should receive case and be governed in order to assign it in the first place. Given the unconstrained occurrences of *te*, the affirmation that *te* be governed and receive case seems vacuous, since *te* seems to assign case by itself anyway; in other words, there does not seem to be any case in which *te* is not governed and hence is unable to assign case. Furthermore, the assumptions regarding the case-marking in NCs are stipulative: in one instance IP receives case from a postposition in COMP, a somewhat unusual situation in UG. In the other instance, when the article occupies the COMP position, the CP itself receives case, but it is (mysteriously) transmitted down to *te* in INFL.

Finally, on both theoretical and empirical grounds, the contention that Ortiz de Urbina's analysis predicts the DP distribution of NCs is somehow puzzling. Distribution has always been regarded as a criterion for constituency; if two constituents show exactly the same distribution but belong to different categories, and this is claimed to be a prediction of a given analysis, one has reason to believe that the premises of that analysis are questionable.

From now on, I intend to refocus the whole issue of NCs and propose several empirical tests to distinguish DPs from sentences in Basque. On this basis, it will become clear that nominalized clauses do indeed behave (as far as distribution goes) exactly as regular DPs, which is predicted if they have a nominal head. How internal sentential properties and external DP distribution is allowed in the grammar of Basque will be shown in section 2.4 to be another instantiation of a possibility available in UG.

2.3.3. Sentences vis-a-vis Determiner Phrases

There are at least five/six major tests specific to Basque which distinguish sentences and DPs:

a. DPs may bear the ergative marker *k*, which is regarded among Basque generativists to be a reflection of the DP's being the subject at D-S (Levin (1983),

(13) The locative singular is *an*, but *a* is considered to be the overt realization of the singular article, and *n* the locative postposition proper. In other postpositions, there is no trace of the article (*etxe-rik* 'from the house'; singular DET is zero). It is not clear why Goenaga does not represent (48b) as an instance of a CP (of the type represented in (47b)) being a complement to COMP, since after all the postposition is singular:

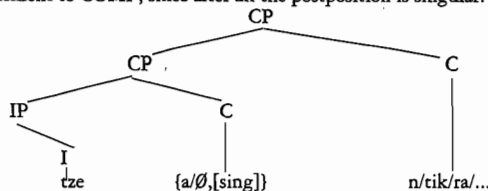

This raises the question of what under his analysis is the source of the singular interpretation of the postpositions in (48b) in the absence of a determiner or a noun.

Eguzkitza 1986, Ortiz de Urbina 1989, Oyharçabal 1992) (i.e. subjects of both unergative and transitive verbs are marked ergative). Sentences, however, cannot be subjects of these two types of verbs¹⁴:

- (49) [Ainhoa-k] izugarri kezkatzen nau
 -E terrible worry aux
 Ainhoa worries me terribly
- (50) a.* [Datorren urtean zer egin(-ek)] kezkatzen nau
 next year-loc what do (-E)
 What to do next year worries me
 b.* [Ainhoa etor dadila(-k)] kezkatzen nau
 come aux-comp (-E)
 That Ainhoa may arrive worries me

NCs, on the other hand, can be subjects of transitive and unergative verbs and bear ergative case:

- (51) [Ainhoa etortzeak] kezkatzen nau
 arrive-TE-E
 Ainhoa's arriving worries me

The failure of sentences to be subjects of transitives is accounted for by the rule of ergative insertion given in chapter one. Assuming with Emonds (1985) that sentential subjects are dominated at D-S by a DP node with an empty D (and N), the obligatory placement of the ergative morpheme on a lexical D-S subject is violated if a sentence bears no ergative marker. If a sentential subject does have the ergative morpheme, then the insertion conditions of the ergative morpheme itself (and ultimately, the Projection Principle) are violated, since the former can only be inserted in the context +D__ (and not +C__, +I__).

b. Sentential subjects are possible in Basque with unaccusatives and copulatives verbs. But in this case, they are incompatible with wh-movement of a complement unless they are extraposed, a phenomenon well-known in English (Ross 1967, Emonds 1976, 1985, Koster 1978, Stowell 1981):

- (52) a. [Garagardoa] beharrezkoa da nire ustez
 beer necessary is I-gen opinion-inst
 Beer is necessary in my opinion

(14) Ortiz de Urbina (1989) assumes that the complementizer *la* originates in a pre-IP position and then cliticizes onto INFL. He then ascribes the ungrammaticality of (50b) and similar examples to the fact that no-government for the empty COMP is available for sentential subjects (Chomsky's 1986b ECP is assumed). This predicts that *la*-headed CPs could not be adjuncts, which is not correct, since these can be modal or temporal modifiers:

- i. Etxetik nentorrela, Ainhoa ikusi dur ii. Mahaia hormari deusala utzi dugu
 home-abl come-LA see aux table wall-D attach-LA leave aux

As I was coming from home, I've seen Ainhoa We left the table attached ["as it is attaching"] to the wall

If this proposal is recast in terms of head-government (required for empty complementizers according to Stowell 1981 and Aoun et al. 1987), it predicts that *la*-headed CPs should be excluded from sentential subjects (where *that*-deletion occurs in English). The prediction is incorrect too:

- iii. It's true [that/* \emptyset Mary has arrived] iv. [That/* \emptyset Mary has arrived] is true
 v. Egia da [Miren heldu dela] (= iii) vi. [Miren heldu dela] egia da (= iv)

- b. Noren ustez da [garagardoa] beharrezkoa ?
whose
 - c. Noren ustez da beharrezkoa [garagardoa] ?
In whose opinion is beer necessary ?
- (53) a. [Ainhoak garagardoa ekar dezala] beharrezkoa da nire ustez
beer bring aux-comp necessary is
That Ainhoa bring beer is necessary in my opinion
- b.* Noren ustez da [Ainhoak garagardoa ekar dezala] beharrezkoa ?
In whose opinion is that Ainhoa bring beer necessary?
 - c. Noren ustez da beharrezkoa [Ainhoak garagardoa ekar dezala] ?
In whose opinion is it necessary that Ainhoa bring beer ?

In this regard, NCs behave like DPs:

- (54) a. [Ainhoak garagardoa ekartzea] beharrezkoa da nire ustez
beer bring-TE-art necessary is
Ainhoa's bringing beer is necessary in my opinion
- b. Noren ustez da [Ainhoak garagardoa ekartzea] beharrezkoa ?
 - c. Noren ustez da beharrezkoa [Ainhoak garagardoa ekartzea] ?
In whose opinion is Ainhoa's bringing beer necessary?

c. Sentences cannot coordinate with DPs:

- (55) a.*Lehendakariak [presoen askapena] eta [gobernuak suetena
President-E prisoners-gen liberation and government-E cease-fire
negoziatu dezala] eskatu du
negotiate aux-comp demanded aux
The president demanded the liberation of the prisoners and that the
government negotiate a cease-fire
- b.*Lehendakariak [hurrengo batzarraren lekua] eta [hauteskundeak
next meeting-gen place and elections
noizko deitu] aipatu du
when call mention aux
The president mentioned the place of the next meeting and when to call
elections

NCs cannot coordinate with embedded CPs, but they can coordinate with DPs:

- (56) *Lehendariak aipatu du/ditu [gobernuak suetena
mention aux-sg-obj/pl-obj government-E cease-fire
negoziatuko duela] eta [presoak aske uztea]
negotiate aux-comp and prisoners free set-TE-art
The president mentioned that the government will negotiate a cease-fire
and letting the prisoners free
- (57) Lehendakariak aipatu ditu [presoen askapena] eta [gobernuak
mention aux prisoners-gen liberation and [government
suetena negoziatzea]
cease-fire negotiate-TE-a

- f. Nekez lortuko duzu *dirurik*
 hardly get aux money-part
 g. Sinesgaitza da zuk *dirurik* nahi izatea
 Unbelievable is you-E want-TE-art
 Your wanting money is surprising

The descriptive generalization about the partitive morpheme in [-definite] DPs is that it has to be c-commanded by a negative operator or an affective predicate. Many of these c-commanding elements seem to be in spec(I) (cf. chapter one, 1.3.3.) after the application of move α . This is certainly true of *zuk bakarrik* 'you only', *nekez* 'hardly' and *sinesgaitza* 'unbelievable', as can be seen by contrasting (61d-g) with the following ungrammatical examples where the elements that c-command the partitive DP are not immediately followed by the verb:

- (62) * Zuk bakarrik *dirurik* ohos-tu-ko zenuke (cf.(61e))
 (63) * Nekez *dirurik* lor-tu-ko duzu (cf.(61f))
 (64) * Sinesgaitza zuk *dirurik* nahi izatea da (cf. (61g))

A similar case can be made for conditionals (the verb moves to COMP). In the spirit of de Rijk, I will take this observation as sufficient evidence that lexical insertion of the indefinite article is post-transformational. In other words, a [-definite, +singular] determiner in Basque remains empty until after S-S; depending on the scope relations at S-S, [D \emptyset] will be realized as *a* or *rik*:

- (65) a. D, [-definite, +sing] \rightarrow *rik*
 If c-commanded by a *negative* or *affective* operator
 b. D, [-definite, +sing] \rightarrow *a*

Tensed clauses, on the other hand, may surface with the negative complementizer *nik* 'that', studied by Laka (1990) (and more recently by Uribe-etxebarria 1994); this complementizer is undoubtedly related to the partitive morpheme (*r*)*ik*. Nonetheless, tensed CPs headed by the negative complementizer *nik* are restricted to negative contexts and are often excluded in contexts where partitive DPs are not¹⁶:

- (66) a. Zuek etor zaitezten nahi dut
 You come aux-comp want aux
 "I want that you come along"
 b. ? *Gu etorriko garenik* uste baduzu, ...
 we come aux-comp think if-aux
 "If you think that we will come along..."

(16) CPs headed by the negative complementizer are also possible in contexts where doubt is expressed, as Laka remarks in a footnote citing an example from Altube (1929). But this use is also subsumed under the "negative complementizer" account according to her. De Rijk (1972: 170) has the following example, where the negative complementizer is used in a yes/no question:

- i. Uste al dezute dirua nik ostu dedaNIK?
 Do you think that I have stolen the money?

(i), however, is not a genuine yes/no question, but rather expresses amazement and puzzlement on the part of the speaker that his/her audience might actually believe that the speaker stole the money. In no case can (i) be a question about the beliefs of the audience; it rather translates as "you really think that I stole the money?!"

- c. ? *Gu etorriko garenik* espero duzu ?
 We come aux-comp expect aux
 "Do you expect that we (will) come along ?"
- d. *Ez dut zuek etor zaitetzenik* nahi
 "I don't want that you come along"
- e. ?? *Zuek etorriko zinetenik* Ainhoari bakarrik bururatu zitzaion
 you-pl come aux-comp- D only occur aux
 Only to Ainhoa did it occur that you would come along
- f. ?? *Nekez espero dezake inork zuek etorriko zaretenik*
 hardly expect aux anybody you come aux
 Hardly anybody can expect that you will come along
- g. ?? *Harrigarria da Ainhoak zuek etorriko zaretenik* pentsatzea
 surprising is -E think-TE-art
 "Ainhoa's thinking that you will come along is surprising"

Nominalized clauses, on the other hand, may take the partitive case morpheme [(r)ik] in the same contexts DPs do¹⁷:

- (67) a. *Ainhoa etortzea* nahi dut
 come-TE-a
 "I want Ainhoa's coming along"
- b. *Ez dut Ainhoa etortzerik* nahi
 "I don't want Ainhoa's coming along"
- c. *Ainhoa etortzerik* nahi duzu ?
 "Do you want Ainhoa's coming along ?"
- d. *Ainhoa etortzerik* zuk bakarrik aipatu duzu
 you-E only mention aux
 "Only you have mentioned Ainhoa's coming along"
- e. *Nekez lor dezake inork Ainhoa etortzerik*
 hardly achieve aux anybody
 "Hardly anybody can achieve Ainhoa's coming along"
- f. *Sinesgaitza da zuk Ainhoa etortzerik* nahi izatea
 unbelievable is you-E want aux-TE
 "Your wanting Ainhoa's coming along is unbelievable"

These data clearly show that Nominalized Clauses are indeed dominated by a DP node.

f. Finally, DPs may be a complement to all members of category P in Basque. CPs headed by *la* can only occur with the postposition *ko* (which attaches to both DPs and PPs)¹⁸; CPs headed by the complementizer *n*, used in indirect questions

(17) Admittedly, the partitive seems optional in NCs, whereas it is for most part obligatory in regular DPs.

(18) In some dialects, *la* may show up followed by the partitive morpheme *la+rik* when it is a temporal or modal adjunct clause:

i. *Etxetik nentorrelarik*, Ainhoa ikusi dut (cf. (i) in footnote (14))

It is not clear whether *larik* is a separate complementizer.

and relative clauses, may take some of the Ps that attach to DP: locative, ablative, instrumental, destinative:

- | | | | |
|---------|----------------------------|----|-----------------------------------|
| (68) a. | Ainhoa etorri deN-ean... | b. | Ainhoa etorri deN-etik... |
| | arrive aux-N-loc | | aux-N-abl |
| | When Ainhoa has arrived... | | Since Ainhoa arrived... |
| c. | Ainhoa etorri deN-ez... | d. | Ainhoa etorri deN-erako... |
| | Since/because Ainhoa | | aux-N-dest |
| | has arrived... | | By the time Ainhoa has arrived... |

It is very plausible that (68a,b,d) should be analyzed as headless relative clauses with an empty head noun; *nez*, on the other hand, has been lexicalized as an independent complementizer. I will not pursue this claim here although I believe there is evidence which show this is the correct approach¹⁹. I will simply note that, regardless of (68) and unlike CPs headed by *la*, NCs may be complements to *all members of category P* in Basque without any restriction (cf. Emonds 1976 for a similar situation with English gerunds). This further supports the claim that nominalized clauses are indeed dominated by a DP node.

In view of these six empirical tests, I conclude that NCs are indeed dominated by a DP node. This, far from being a definitive solution by itself, simply reformulates the problem in its true terms: NCs are DPs but have internal sentential structure. In the following section, I will reconcile these two properties in the light of the proposal advanced for English in section 2.1.

2.4. Nominalized clauses as DP-s

One of the basic tenets of the proponents of the DP hypothesis which has been central to the characterization of functional categories (Fukui & Speas 1986, Abney 1987, Speas 1990) is that the latter differ from lexical categories in that they uniquely have the same XP as their complement. It is in this sense that Grimshaw (1991) refers to CP, IP and DP as the "extended projections" of IP (ultimately VP), VP and NP respectively. Hence I propose to analyze Basque NCs as DPs whose complement is an NP headed by the nominal element *te*. Since, unlike the case of derived nominals, the insertion of *te* is not constrained by any purely semantic feature such as ACTIVITY, it follows from the theory outlined in section 2.2.1 that *te* will be subject to late insertion and hence will not be present until PF:

(19) The evidence is that true headless relative clauses are similar to (68):

i. Ni heldu naizeN orduAN ez zegoen inor bulegoan ii. Ni heldu naizeNeAN idazkaria zegoen

At the time I arrived, there was nobody at the office At the [one] I arrived, the secretary was (there)

Morphological evidence aside, one might argue that (68a) requires no context to be interpreted as a temporal clause. In that case, of course, one would have to say that NEAN has become lexicalized and is a complementizer by itself. This claim would further strengthen the point I am making, since we would no longer consider it a sequence of *N* (complementizer) followed by the locative Postposition.

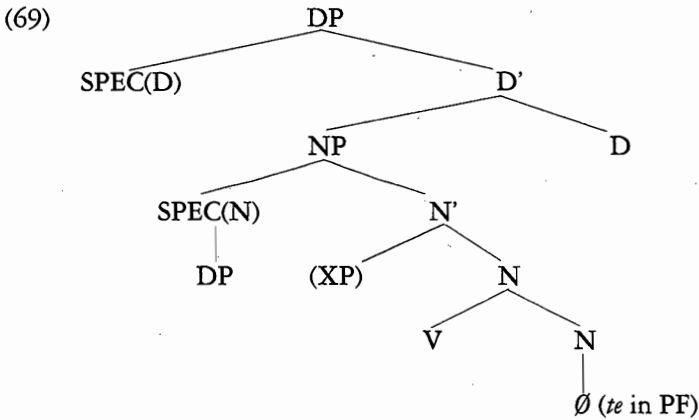

This proposal captures the notion that *te* is invariably a morpheme of category N, a desirable consequence. It also predicts that late insertion of *te* will result in the verb's being the dominant head, the *L-head* as defined in chapter one (section 1.2.3.), which is correct. In view of the contrast between NCs with *te* and with *tu/i/n* (cf. (37)), I propose that these morphemes, when subject to late lexical insertion, bear the syntactic feature [aspect, - /+completed] respectively²⁰ (the latter being the marked value):

- (70) a. *te*], N, +V___ { ((V:+ACTIVITY)) N= }
 b. *n*], *i*], *tu*], N, { [-completed] }
 { [+completed], +V___ }²¹

I assume henceforth that Basque NCs are selected as +V in contexts where both perfective and non-perfective DP-clauses are grammatical and that the *Minimal Structure Principle* of chapter one favors the generation of DP-clauses over an entire sentence (= [CP [IP INFL [VP V]] COMP]), as is also the case in English (cf. section 2.1). In cases where only one type of nominalized clause is possible, the insertion of either nominalizer is triggered by the corresponding syntactic feature ([+/-completed]), and the selecting verb has the subcategorization entry +V^[+completed] or +V^[-completed], as the case may be.

In chapter four, I will provide evidence which show independently that *te* and *i/n/tu* are indeed morphemes of lexical categories also when they occur in periphrastic verb forms (cf. chapter one). The fact that these grammatical formatives may function as aspect markers as well is actually expected since they are inherently specified in the lexicon as [+/-completed].

The structure proposed in (69) and the lexical entries in (70) also eliminate the need to assign different categorial status to articles and postpositions on the basis of NCs; these are now invariably D and P throughout and have NP and DP respectively as sisters.

(20) See Zagona (1989) for arguments that [+/- completed] rather than [+/-perfective] is the adequate feature.

(21) The perfective morphemes also form derived nominals (cf. ch. three), but this is irrelevant at this point.

2.4.1. *Alternative DP analyses*

In a footnote, Ortiz de Urbina (1989: 201-2) credits I. Laka for suggesting a structure of Basque NCs similar to the one proposed by Suzuki (1988) for English:

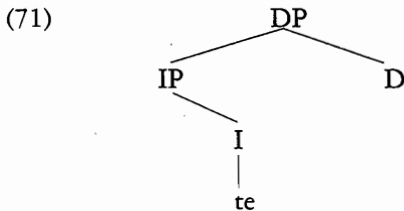

This is also suggested by Elordieta (1990). I believe this Suzuki-style proposal undermines the notion that nominalized clauses and English gerunds are nominal. Leaving aside the fact that the licensing of IP as complement to DET requires some argumentation which Suzuki does not provide²², it makes the DP hypothesis vacuous since the DP hypothesis was meant to capture *inter alia* the necessary relation between the functional head DET and a lexical head N in the first place. In other words, a Suzuki-style proposal, besides missing some generalizations about the nature and use of *ing* (and ultimately *te*), simply *describes* that gerunds have a DP external distribution and internal sentential structure. But by no means does it predict/explain why this should be so. The Nominal Head hypothesis, on the other hand, predicts that if a language has a nominal morpheme (which subcategorizes as +V___) that is subject to late lexical insertion, not constrained by a purely semantic feature and not restricted to any subclass of verbs, it will have a nominalized clause of the type represented by English DP-gerunds and Basque NCs, with external noun phrase distribution and internal sentential structure. This is true of a wide range of unrelated languages: English *ing*, Basque *te*, Romance infinitives headed by articles derived by zero-suffixation (Spanish, Portuguese, Italian) (cf. Plann 1981, Salvi 1982), Turkish *dik*, *yemek* and *me* (Esen 1973, George & Kornfilt 1981), and Quechua *sqa* and *na* (Muysken & Lefebvre 1988, Muysken 1989)²³.

In the next subsections I look into the possibility that the assignment of “clausal” (i.e. absolutive/ergative) case to the subject of NCs may depend on the movement of [V-N] to DET. Irrespective of this, it will become clear that the INFL-like element present in NCs is the determiner itself (the article), rather than the nominalizing suffix.

2.4.2. *The case of lexical subjects*

Despite some cases of obligatory control not to be discussed here²⁴, nominalized DP clauses in Basque may usually have lexical subjects when they occur in argument positions and as complements to Ps:

(22) Suzuki acknowledges that his proposal predicts that NPs may be complements to Comp, which is unattested (Grimshaw 1991). My understanding is that nothing in his framework prevents CP-D, VP-D, or VP-C combinations, etc.

(23) It appears that the morpheme *must* also exist in the language as derivational. This is certainly the case in Romance, English, Basque and, apparently, Turkish (Sebuktin 1971) and Quechua (Costa 1972).

(24) Notoriously, purposive clauses headed by the adlative postposition RA when they occur with motion verbs:

- (72) a. [Ainboak bibolina jotzeak] harritzen nau
 -E violin play-TE-art-E surprise aux
 Ainhoa's playing the violin amazes me
- b. Auzokoek ez deritzote ondo [Ainboak bibolina jotzeari]
 Neighbors no opine well TE-D
 The neighbors don't approve [dative] of Ainhoa's playing the violin
- c. Giroa baretu egin zen [Ainboak bibolina jotzean]
 Atmosphere ease aux TE-loc
 The atmosphere eased upon Ainhoa's playing the violin
- d. [Ainboak bibolina jotzeagatik] ez da ezer konpontzen
 TE-mot no aux anything solves
 Nothing is solved because of Ainhoa's playing the violin
- e. Jende asko [Ainboak bibolina jotzeaz] harritzen da
 people many TE-inst amaze is
 Many people are amazed [instrumental] at Ainhoa's playing the violin

As pointed out in section 2.3, (DP) subjects of unergative and transitive verbs (in the sense of Burzio 1986) bear the ergative morpheme *k* ("ergative case" in traditional terms), whereas subjects of unaccusatives bear no marker whatsoever ("absolutive case"), a fact that it is standard to assume reflects the subject's D-S position. My point of departure is what I consider the null hypothesis: whatever makes case-marking possible in tensed clauses must also be present in NCs. If, by assumption (AGR in) INFL assigns case in tensed sentences by government, then INFL or an INFL-like element must be present in NCs. I will show that this is the case in Basque "clausal" DPs when they are headed by the article (but not otherwise).

2.4.2.1. Arguments for the presence of an INFL-like element inside NCs

a. In Basque, gapping of the verb seems to be dependent on its being moved to (or associated with) INFL; gapping of V alone or INFL alone renders sentences fairly deviant, as is in fact also the case in English²⁵:

- i. [e (?? zuk) filmea ikustera] joan gara
 We went [to e (you) see a movie]

And also verbs like *debekatu* 'forbid', *beharri* 'force', *urzi* 'quit', *ekin* 'engage in same activity', etc. Interestingly enough, Salaburu (1984) considers the following sentence "grammatical" but pragmatically odd:

- ii. Joni eta Mireni debekatu diet [semeeek elkar ikustea]
 I forbid Jon and Miren [their sons' seeing each other]

He also suggests that the empty subjects in NCs may be *pro*, a position implicitly adopted in Goenaga (1984). This would amount to saying that these instances of obligatory control are in fact *pro* control. Ortiz de Urbina also entertains this possibility (and the problems it poses) as well as the alternative that both subject and object gaps are variables bound by empty operators (cf. Huang 1984, 1989). I will not pursue this matter here. As for verbal projections headed by *te-n* (*te* followed by the locative P) I argue in Artiagoitia (1991) and chapter four that they have a different structure altogether, similar to English bare "VPs" (cf. Emonds 1985: ch.2).

(25) I assume that all forms of the reconstructed modal auxiliary verb **ezan* (e.g. *lezake* in the example (73)) are mere spellouts of INFL, unlike the forms of *ukan* 'to have' and *izan* 'to be', which are main verbs. Cf. chapter four, section 4.1. Recall also from chapter one that a finite INFL moves to COMP in the unmarked (verb final) word order.

- (73) a. *Ainhoak ardoa ekar lezake eta Asierrek INFL_i patxarana [v Ø] [C [I Ø]_i]*
 wine bring aux and patxaran
 Ainhoa could bring wine and Asier patxaran
- b. ?? *Ainhoak ardoa ekar lezake eta Asierrek INFL_i patxarana eros [C [I Ø]_i]*
 ?? Ainhoa could bring wine and Asier buy patxaran
- c. * *Ainhoak ardoa ekar lezake eta Asierrek INFL_i patxarana [v Ø]*
 [C [I lezake]_i]
 * Ainhoa could bring wine and Asier could patxaran

In (73a) both V and INFL (in COMP) are gapped and the sentence is grammatical. (73b), where only INFL has gapped, is marginal (although the judgements may vary); in (73c), on the other hand, the verb alone has gapped and the sentence turns out to be ungrammatical. Let us now consider the situation in tenseless (indirect) questions:

- (74) a. *Erabaki dugu nori [I/V eman_i] diskoa V_i eta nori [I/V eman_i] liburua V_i*
 decide aux who-D give disk and who-D give book
 We have decided who to give the record to and who to give the book to
- b. *Erabaki dugu nori [I/V eman_i] diskoa V_i eta nori [I/V Ø] liburua V_i*
 We have decided who to give the record to and who the book to
- c. *Erabaki dugu nori [I Ø] diskoa eman eta nori [I Ø] liburua eman*
 who-D disc give and who-D book give
 We have decided who to give the record to and who to give the book to
- d. ?? *Erabaki dugu nori [I Ø] diskoa eman eta nori [I Ø] liburua [v Ø]*
 We have decided who to give the record to and who the book to

Unlike in tensed clauses, in tenseless indirect questions like (74), the wh-phrase/verb adjacency is not obligatory, as pointed out by Laka & Uriagereka (1987). This is a consequence of the fact that V-to-I movement is optional for non-finite clauses (cf. Pollock 1989a). As in chapter one, I assume wh-phrases move first to spec(I) and then further to spec(C) in order to satisfy the [+WH] subcategorization requirement of the governing verb (cf. chapter one, 1.3.4). Gapping in (74b) is possible because the verb has moved to INFL and acts as in tensed clause (it may assign the f-feature [+operator]); as a result, it is adjacent to the wh-phrase. Gapping is not possible in (74d) (derived from (73c)) because the gapped verb is standing by itself and no movement to empty INFL has taken place.

That NCs allow gapping of the verb-*te*-article sequence suggests some INFL-like element is involved:

- (75) A: *Zer erabaki duzue?*
 What have you decided (on)?
- B1: *Ainhoak ardoa ekartztea eta Asierrek patxarana ekartztea*
 wine bring-TE-art and patxaran
 Ainhoa's bringing wine and Asier's bringing patxaran
- B2: *Ainhoak ardoa ekartztea eta Asierrek patxarana [Ø]*
 Ainhoa's bringing wine and Asier's [Ø] patxaran

b. Possessive anaphors (extensively studied by Rebuschi 1984, 1985) in Old Basque and in some northeastern dialects require a clausemate DP antecedent that is

marked ergative, absolutive, or dative; that is to say, the three DPs that participate in agreement with INFL:

- (76) a. * Pello_i [bere_i emaztea hil dela] esan du
 Pello-E his own wife die aux-comp say aux
 Pello has said that his own wife has died
- b. Pello_i bere_i emaztea hil zaio
 Pello-D his own wife die aux
 His own wife has died on Pello [dative]
- c. Pello_i bere_i emaztea maite du
 Pello-E his own wife love aux
 Pello loves his own wife
- d. *Bere_i emaztea Pello_irekin_i haserretu da
 his own wife Pello-with get-angry aux
 His own wife has gotten mad at Pello [commitative]

Remarkably, similar effects obtain in NCs:

- (77) a. * Pello_i [bere_i emaztea Donostian geratzea] nahi du
 San Sebastian stay-TE-art want aux
 "Pello wants his own wife's staying in St. Sebastian"
- b. Tamalgarria da [Pello_i bere_i emaztea hiltzea]
 Regrettable is Pello-D his own wife die-TE-art
 His own wife's dying on Pello is terrible
- c. Normala da [Pello_i bere_i emaztea maitatzea]
 normal is Pello-E his own wife love-TE-art
 Pello's loving his own wife is normal
- d. *Tamalgarria da [bere_i emaztea Pello_irekin_i haserretzea]
 regrettable is his own wife Pello-com get-angry-TE-art
 His own wife's getting mad at Pello is terrible

If the agreement process between dative, absolutive and ergative DPs and INFL is what makes them possible antecedents for the possessive anaphors, some INFL-like element must be present in NCs.

c. Zagona (1991) has argued that the availability of a present moment reading for simple present tenses is dependent on the verb's raising to INFL. In English, the simple present cannot have a present moment interpretation because INFL lowers to V, just the opposite of what happens in Spanish. In Zagona's framework, 'times' are expressed syntactically as temporal arguments of a clause. INFL has a temporal θ -grid; it assigns a temporal role to its complement VP, and a temporal role to the external argument, the Speech time (=T), which she assumes must move to spec(C) for its grammatical licensing. Present moment interpretations of the present tense arise from the possibility of satisfying Principle A of Chomsky's (1986a) Binding

- (26) a) Minimal Governing Category: the minimal XP containing α , a governor of α , and a subject (i.e. a Complete Functional Complex (Chomsky 1986b: 169).
 b) Principle A: an anaphor must be bound in its MGC
 Principle B: a pronominal must be free in its MGC
 Principle C: An r-expression is free (in the domain of the head of its chain)
 In Zagona's terms, "bound" means "coindexed" with a c-commanding A-position.

Theory²⁶: the external temporal argument binds the internal argument in its Minimal Governing Category (MGC). Assuming that the internal temporal argument VP inherits a temporal coindex from its head V, the Minimal Governing Category for V+INFL in a V-raising language like Spanish containing (V+INFL) and a governor for (COMP) is CP. Since CP contains the temporal subject in spec(C), VP can satisfy Principle A of Binding Theory and a present moment reading is available. In I-lowering languages like English, the MGC for V+INFL is IP, which does not contain the temporal subject. Hence no present moment reading is available for English simple present tenses:

- (78) a. [CP T_i [IP María [INFL+V canta_j] [VP e_j]]]
 MGC for INFL+V_j is CP; T_i binds INFL+V_j
- b. [CP T_i [IP Mary INFL [VP [V+INFL sings_j]]]]
 MGC for V+INFL_j is IP; T_i doesn't bind INFL+V_j in its MGC

Basque simple present tenses do have a present moment interpretation as a result of V-to-I movement (which lends support to the correctness of Zagona's approach; cf. chapter four, 4.1.2):

- (79) Ainhoa etxera (omen) dator (*omen)
 home apparently comes
 Ainhoa is apparently coming home

A potentially interesting test for Zagona's analysis comes from English gerunds. DP-gerunds should be temporally interpreted with respect to the matrix verb tense when functioning as complements (cf. Hornstein 1990), but nothing prevents them from having their "independent" tense, if they are in subject position. This is not possible on general grounds because gerunds lack an INFL node proper that could assign an external temporal argument (cf. 2.1)²⁷:

- (80) a. Mary's singing La Traviata may turn out to be a success/ sounds like a good idea/ caused a protest yesterday
- b. A: What is Mary doing?
 B: She is singing La Traviata right now
 A: * [Mary's singing La Traviata right now] is surprising
 (cf.c. That Mary is singing La Traviata right now is surprising)

Basque NCs, on the other hand, may have a present moment reading provided they are in subject position:

- (81) a. A: Zertan dabil Ainhoa? B: Oraintxe bertan kantatzen dabil
 What is Ainhoa doing? now right singing walks
 She is singing right now
- A: Ba [(Ainhoak) oraintxe bertan kantatzea] harrigarria da
 well sing-TE-art surprising is
 Well, (Ainhoa's) singing right now is surprising

(27) Cf. Hornstein (1990), who states that gerunds lack the S(peech time) point.

This supports the notion that some INFL-like element is present in Basque clausal DPs, which makes it possible for these constituents to have a V-to-I-like situation. The argument can be construed as follows: let us assume that the temporal subject in Basque moves to spec(I) for its grammatical licensing instead to spec(C) as in English or Spanish, and that the functional head DET can assign a temporal role to NP in a nominalization when a verb is the L-head of NP (N is zero until after S-S by late lexical insertion). If we grant for the time being that the $[N\ V-N]$ head moves up to DET in a nominalized clause (the article is a bound morpheme), the MGC for the verb of the nominalized clause in subject position will be IP: it contains the DP-clause with the verb as the only lexically realized head in DET (the indefinite article is not inserted until after S-S as we just saw in 2.3.3.e above), and a governor of DP, namely INFL itself. IP contains the external temporal argument, which can bind the temporal index of the nominalized verb in DET within its MGC; thus we obtain a present moment interpretation of the DP-clause.²⁸

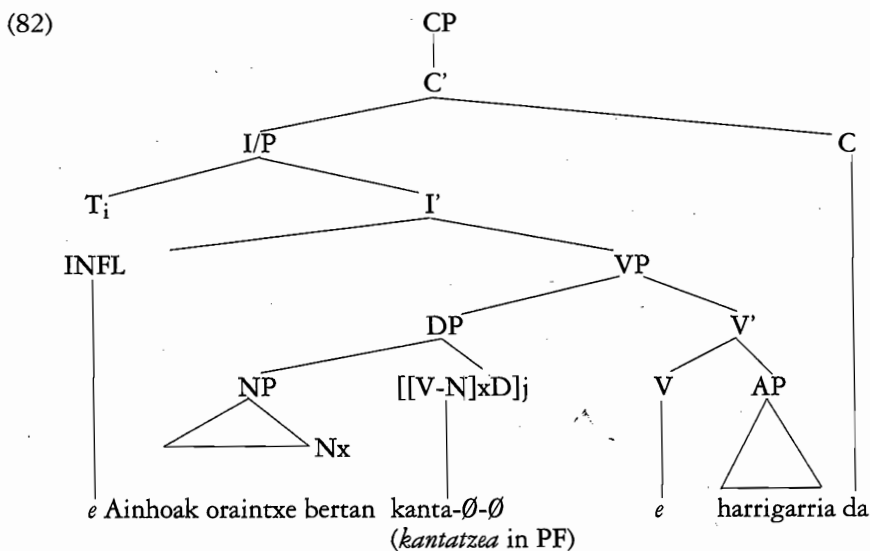

It should be noted that even if English DET (as in (7)) is taken to be an INFL-like element, there is no $[V-N]$ to D movement anyway, which would license a present moment reading for the gerund in subject position. Nothing can possibly trigger it given that the article is *not* a bound morpheme.

2.4.2.2. INFL-like element = DET

There are two clear candidates for the INFL-like element in Basque NCs: the suffix *te* and the determiner. Regarding *te* as the INFL-like element would be in keeping with Suzuki's and Goenaga/Ortiz de Urbina's analyses and would seem to

(28) Another alternative is to assume that the temporal subject is in spec(C) as proposed by Zagona, and that the closest governor for the verb in the nominalized clause in subject position is COMP, and not INFL, since INFL moves to COMP (a case of substitution) in the unmarked word order.

undermine the proposal we have made here since we would be forced to assume that *te*, a morpheme of category N, retains INFlectional properties. I will suggest instead that DET (i.e. the article) is the INFL-like element.

Nominalized DP clauses may take determiners other than the article *a*]; these include the demonstratives *hau* 'this', *hori* 'that', which differ from the article in that they are not suffixes but independent words:²⁹

- (83) a. Batetik bestera ibiltze hau zorakeria hutsa da
 one-abl other-adl walk-TE this craziness pure is
 This going from here to there is crazy
 b. Egunero patxarana edaten ibiltze horrek ez dizu onik ekarriko
 Every day drinking walk-TE this-E no aux good bring
 "This being drinking patxaran every day won't do you any good"
- (84) a. Batetik bestera ibiltzea zorakeria hutsa da
 one-abl other-adl walk-TE-art craziness pure is
 Going from here to there is crazy
 b. Egunero patxarana edaten ibiltzeak ez dizu onik ekarriko
 walk-TE-art-E
 "Being drinking patxaran every day won't do you any good"

As we have seen elsewhere in this chapter, the article also differs from the demonstratives in that it may be indistinctively be specified as [+/-definite]. As de Rijk (1972) shows, [-definite] DPs surface with (shift to) the partitive morpheme in certain contexts (cf. section 2.3.3 above), e.g. when c-commanded by negation. DPs headed by demonstratives never do:

- (85) a. Ainhoak *dirua* ekarri du ([+/-definite])
 money-art bring aux
 Ainhoa has brought the money/ money
 b. Ainhoak ez du *dirua* ekarri ([+definite]/ *[-def])
 Ainhoa has not brought the money
 c. Ainhoak ez du *dirurik* ekarri (*[+def]/ [-def])
 Ainhoa has not brought (any) money
- (86) a. Ainhoak *diru hau/hori* ekarri du
 Ainhoa has brought this/that money
 b. Ainhoak ez du *diru hau/hori* ekarri
 Ainhoa has not brought this/that money
 c. * Ainhoak ez du *diru haurik/horirik* ekarri
 Ainhoa has not brought any (of) this/that money

(29) But not HURA 'that over there' according to Goenaga (1984: 87):

i. * [Mendira joate hura] erabaki genuen
 mountain-adl go-TE that decide aux
 We decided (on) that going hiking

I agree with the judgement; however, I do think that NCs headed by HURA are acceptable in the appropriate contexts:

ii. [Mendira elurretan barrena joate hark] txikitu gintuen
 That going hiking in the snow killed us (*hark* = *hura*-E)

NCs headed by the article behave as [-definite] in this respect, since they alternate with the partitive morpheme (cf. section 2.3.3.e):

- (87) a. *Dirua ekartzea* lortu dugu
 money bring-TE-art achieve aux
 "We have achieved bringing (the) money"
 We have succeeded in bringing (the) money
- b. *Ez dugu lortu dirua ekartzerik*
 "We have not achieved (any?) bringing (the) money"
 We have not succeeded in (any?) bringing (the) money [cf. also c.
Ez dugu lortu dirua ekartzea]

I have assumed that de Rijk's transformational treatment of partitive assignment to [-definite] DPs is best interpreted as implying that the [-definite] article (whether its realization is *a* or (*r*)*ik*) is not present until PF since its lexical insertion is only possible post-transformationally: *a* or (*r*)*ik* are not inserted under a [-definite] DET until move has applied.

If this is so, we obtain two different S-S representations for NCs depending on whether they are headed by the article or demonstratives:

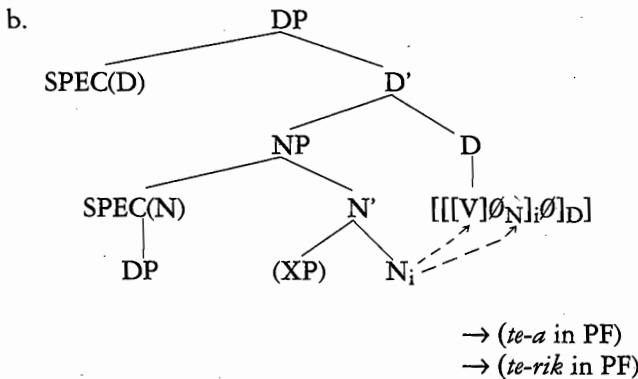
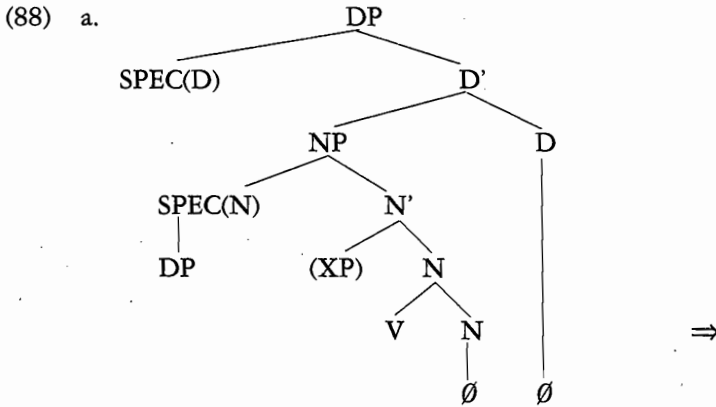

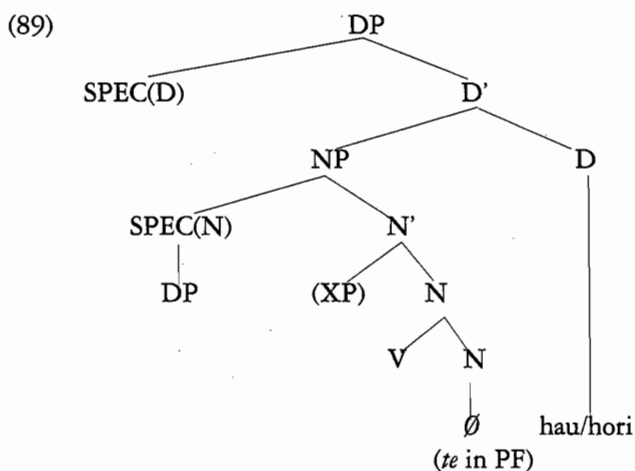

Head-movement of the base-generated [V-N] head in (88) is triggered by the lexical entry of the article, which is a suffix. Given the definition of L-head in chapter one, repeated here for convenience:

- (90) *L(lexical)-head*: The L(lexical) head of X^0 is the rightmost lexically filled X^0 dominated by X^0 (and by no other maximal projection under X^2).

it becomes clear that V is the L-head of DP in (88) as a result of movement, whereas DET is the L-head in (89)³⁰. The difference between (88) and (89) is a difference in the relative position of the verb with respect to the determiner and its NP complement. In both cases, however, N stands in the same position with respect to V [except that N is not a head in (88) but is a head (though not the L-head) in (89)]. The potential syntactic differences between the two configurations, if any, will be significant to determine what is at stake. And there are indeed three basic differences:

a. As seen above ((72)), lexical (nominative) subjects are possible in NCs headed by the article; in NCs with demonstratives of the type diagrammed in (87), this is ruled out:

- (91) a. Zuk patxarana etengabe edatea zorakeria hutsa da
 You-E patxaran constantly drink-TE-art craziness pure is
 Your drinking patxaran constantly is crazy
- b. * Zuk patxarana etengabe edate hau txorakeria hutsa da
 drink-TE this
 "This your drinking patxaran constantly is crazy"

b. Unlike NCs headed by the article, those headed by demonstratives resist gapping:

(30) Note that definition restricts L-heads to their closest dominating XP; this locality condition can only be avoided by head-movement.

- (92) Zer gorrotatzen duzue?
 What do you hate?
- a. [Bazkarian ura edatea] eta [afarian esnea edatea]
 Lunch-loc water drink-TE-art and supper-loc milk
 Drinking water with lunch and drinking milk with supper
 - b. [Bazkarian ura edatea] eta [afarian esnea [Ø]]
 "Drinking water with lunch and milk with supper"
 - c. [Bazkarian ura edate hori] eta [afarian esnea edate hau]
 That drinking water with lunch and this drinking milk with supper
 - d. * [Bazkarian ura edate hori] eta [afarian esnea [Ø]]
 That drinking water with lunch and milk with supper

The contrast between (92b) and (92d) correlates to the presence/absence of V in the D position at S-S.

c. Unlike those represented by (88), NCs headed by demonstratives cannot have a present moment reading (cf. example (81) above):

- (93) A: Zertan dabil Aihnoa? B: Oraintxe bertan kantatzen dabil
 What is Ainhoa doing? She is singing
 A: * Oraintxe bertan kantatze hau harrigarria da
 sing-TE this
 "This singing right now is surprising"

No present moment reading for NCs with demonstrative is possible because the MGC for the verb contained in NP is the DP-clause (the demonstrative is a governor for the V-N complex), and the external temporal subject of the matrix clause cannot bind it inside DP. Again, the availability of a present moment reading for NCs seems to depend on the verb's being in DET.

In conclusion, these three crucial differences pointed out^{31 32} above indicate that the Determiner is the functional case-marking element in question for the INFL-

(31) A fourth difference is that NCs with articles permit extraction of a constituent, whereas NCs headed by demonstratives do not:

- ia. [Bazkalostean patxarana edatea] aholkatzen dut/ gustatzen zait
 after-lunch-loc drink-TE-art recommend aux please aux
 I recommend drinking patxaran after lunch/ drinking patxaran after lunch is pleasing to me
- b. Zer aholkatzen duzu/ gustatzen zaizu [t edatea bazkalostean] ?
 What do you recommend [drinking t after lunch] ?/
 "What is [drinking t after lunch] pleasing to you?"
- ii. [Bazkalostean patxarana edate hau] aholkatzen dut/ gustatzen zait
 I recommend this drinking patxaran after lunch/
 This drinking patxaran after lunch is pleasing to me
- b. * Zer aholkatzen duzu/ gustatzen zaizu [t edate hau bazkalostean] ?
 What do you recommend [this drinking t after lunch] ?/
 "What is [this drinking t after lunch] pleasing to you ?"

This contrast is reminiscent of the familiar definiteness effect. See Suzuki (1988), Stowell (1989), and Torrego (1987) on extraction from DPs headed by demonstratives. Torrego assumes that ungrammaticality arises because of subadjacency (either because demonstrative-headed DPs are inherent barriers like tensed CPs or else because demonstratives don't L-mark their complements; hence extraction crosses two barriers =NP, DP).

like properties studied in the previous subsection only obtain when V-N to D movement takes place. The data also suggest that Basque DET is “defective” in that it only shows INFL-like properties when a verb is incorporated to it. Notice also that regarding *te* as the INFL-like element (cf. Goenaga’s and Ortiz de Urbina’s analysis) would predict that no contrast in terms of case-assignment and gapping should exist between NCs headed by demonstratives and by the article since *te* is governed by the demonstrative (and therefore it should be able to assign nominative), and V and *te* are always realized as a single word.

2.4.2.3. Case-assignment in clausal DPs

The mechanism by which lexical subjects in NCs are assigned nominative case is hence dependent on the presence of V in D; or put differently, on the verb’s being the L-head of the DP at S-S. I propose that DET assigns nominative in Basque just in case its terminal element is a verb³³:

- (94) The functional category D in DP assigns nominative case if (and only if) a verb is its L-head at S-S.

In other words, the possibility for DET to assign nominative case is dependent on its having a verbal head incorporated into it. Since this is not a possibility in English for independent reasons, it follows that DET in English gerunds can only assign the case usually associated with DPs (namely, genitive). In view of similar other cases where the case displayed by the subject of nominalized clauses is genitive (English, Quechua, Turkish), Basque appears to represent the marked option³⁴. This seems a desirable conclusion. Note that most languages, including Basque, assign different case to a clausal subject and a nominal (DP-internal) subject. What (94) says is that in such languages, a “clausal” subject in DPs will be available under very specific and limited circumstances. Incidentally, the case-assignment mechanism proposed in (94) predicts that NCs headed by demonstratives should have genitive subjects; that is, the case that DET assigns under the usual conditions. This prediction is borne out by the data:

(32) There are other differences between the demonstrative and the article in Basque: the former does not allow N and N’ gapping in a sister NP, whereas the latter does. This may follow from the fact that Basque demonstratives are not head-governors but articles are (functional categories differ crosslinguistically w.r.t. their governing capacities (cf. Contreras 1989):

- | | |
|---|---|
| i. a. Ainhoaren argazkia eta Asierren argazkia | b. Ainhoaren argazkia eta Asierren- \emptyset -a |
| The picture of Ainhoa and the picture of Asier | The picture of Ainhoa and the (one) of Asier |
| ii.a. Ainhoaren argazki hau eta Asierren argazki hori | b. *Ainhoaren argazki hau eta Asierren [\emptyset] hori |
| This picture of Ainhoa and that picture of Asier | This picture of Ainhoa and that (one) of Asier |

(33) Due to their restricted use in modern Basque, so far I have not been able to confirm whether possessive anaphors are licensed in DP-clauses headed by demonstratives.

(34) In fact (94) is a consequence of the fact that both the Determiner and the nominalizer can be empty at S-S. Late insertion of the determiner in Basque is probably marked. But other factors may intervene crosslinguistically to prevent (94).

- (95) a. Ainhoaren batetik bestera ibiltze hau zorakeria da
 -gen one-abl other-adl walk-TE this craziness is
 "This going from here to there of Ainhoa's is crazy"
- b. Ainhoaren patxarana etengabe edate horrek harritu egiten nau
 -gen constantly drink-TE that-E surprise do aux
 "That constantly drinking patxaran of Ainhoa's surprises me"

We may try to generalize (94) as to include the functional head INFL. Obviously, a [+finite] INFL may assign case whether a lexical V occupies the INFL position or not (e.g. in English). But where this is not true, nominative case-assignment may after all be dependent on the presence of V under a functional category (cf. Koopman 1984 on Vata):

- (94)' a. A positively specified F(unctional) category assigns nominative case if F governs XP, where V is the L-head of XP
 b. Otherwise, F assigns nominative case if V is the L-head of FP.

Part (a) is aimed to account for English modals and finite INFL; (b) maximally generalizes the conditions under which DET or INFL may assign nominative case. In languages where both DET and INFL always assign nominative case, i.e. DP-subjects and IP-subjects are always assigned nominative (cf. Abney 1987: ch.1), the specification of V as L-head in (94)' probably extends to N. Having outlined the general conditions for case-assignment in Basque, I now turn to the discussion of some seemingly sentential properties of NCs.

2.5. Some apparent clausal properties of nominalized DP-clauses

There are two further properties of NCs shared by tensed clauses which, according to Ortiz de Urbina (1989), seem to suggest the existence of a spec(C) position and COMP position respectively: a) the possibility of having wh-phrases inside NCs which pied-pipe the entire nominalized clause to some initial position in the matrix clause; and b) the possible existence of "V-2" phenomena (whereby V-2 we mean the obligatory adjacency between wh-phrase and the verb) in NCs. In this section, first I will briefly show that the first property (pied-piping) is in fact a property of all XPs in Basque, not exclusive of sentences, and that the operator which triggers pied-piping need not be in a spec(C) position inside the pied-piped constituent, as is the case in relative clauses. And second, I will suggest that "V-2" is not obligatory in NCs (it is only so in tensed clauses) and that apparent operator-verb adjacency in NCs can be otherwise explained within the DP analysis pursued here. Crucially, I will suggest that analyzing operator-nominalized verb sequences as movement to spec(C) and COMP respectively is problematic for (and even incompatible with) Ortiz de Urbina's approach to operator-verb sequences in tensed clauses.

2.5.1. *Pied-piping*

In Basque (and reportedly also in Quechua (Ortiz de Urbina 1989: ch. 4, wh-phrases in CP complements may directly move to some sentence initial specifier position in the matrix clause (spec(C) in Ortiz de Urbina's analysis) or else they may pied-pipe the entire CP complement to that position. The trees in (96) correspond to Ortiz de Urbina's analysis:

- (96) a. Nora_i uste duzu [t_i joango dela Ainhua] ?
 where think aux go aux-comp
 Where_i do you think [t_i that Ainhua will go] ?
 b. [Ainhua nora joango dela] uste duzu ?
 "[That Ainhua will go where] do you think ?"

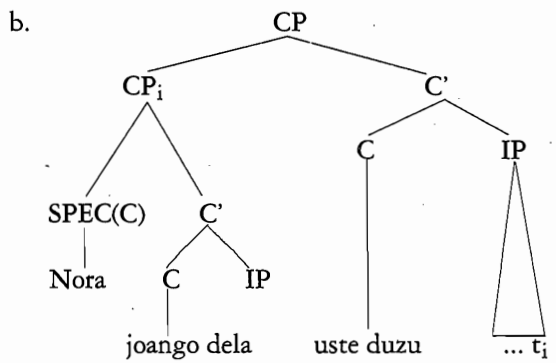
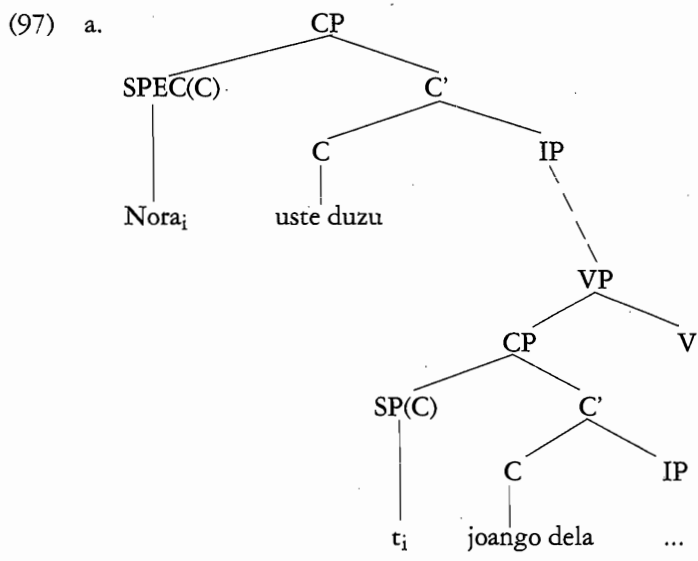

In (97b), Ortiz de Urbina assumes that the wh-element occupies the embedded spec(C) position. In the case of adjunct CPs or CPs embedded in adjunct PPs, direct

extraction of the *wh*-element is ruled out because of the familiar Condition on Extraction Domains (Huang 1982) asymmetries; but clausal pied-piping can overcome this:

- (98) a. *Zer_i joan da Ainhoa etxera [CP t_i ikusi duzunean] ?
 what go aux home see aux-comp-loc
 What_i has Ainhoa gone home [when you have seen t_i] ?
 b. [Zer ikusi duzunean] joan da Ainhoa etxera ?
 [When you have seen what] has Ainhoa gone home ?
- (99) a. *Ze filme_i aldegin duzue hemendik [pp [CP t_i ikusi] ondoren] ?
 which movie escape aux here-abl see after
 Which movie_i have you taken off [after seeing t_i] ?
 b. [pp [CP Ze filme ikusi] ondoren] aldegin duzue hemendik ?
 [After seeing which movie] have you taken off ?

The (a) examples are clear violations of subadjacency; this is avoided in the (b) examples by pied-piping the entire syntactic island. Nominalized DP clauses appear to behave like tensed clauses in this respect: direct extraction of the NC is possible if the DP is in complement position; and a *wh*-element may always pied-pipe the entire NC.

(100) Complement NCs:

- a. Zer_i erabaki du Ainhoak [t_i ikastea] ?
 What has Ainhoa decided (on) studying ?
 b. [zer ikastea] erabaki du Ainhoak ?
 what study-TE-art decide aux -E
 [studying what] has Ainhoa decided (on) ?

(101) Subject/Adjunct NCs:

- a. *Zer_i erakartzen zaitu [t_i ikusteak] ?
 What does [seeing t] attract you ?
 b. [Zer ikusteak] erakartzen zaitu ?
 what see-TE-art-E attract aux
 [Seeing what] attracts you ?
 c. *Zer_i joan zara etxerantza [t_i edatean] ?
 What have you headed home [upon drinking t] ?
 d. [Zer edatean] joan zara etxerantza ?
 what drink-TE-loc go aux home-adl
 [Upon drinking what] have you headed home ?

Based on similar data to the one presented above, Ortiz de Urbina claims that NCs have a spec(C) position, which makes it possible for a *wh*-phrase in that position to pied-pipe the entire constituent. In other words, pied-piping would be an argument for the existence of spec(C), hence CP. Three arguments speak against this claim: first, pied-piping in Basque is not restricted to CPs, but is also a property of DPs, PPs, and APs, which all lack spec(C) positions.

- (102) a. [Nori buruzko istorioak] kondatu dizkizute ?
 who-D head-inst-KO stories tell aux
 [Stories about whom] have they told you ?
- b. [Noizko egunkarian] irakurri duzu berri hori ?
 when-KO paper-loc read aux news that
 [In the newspaper "from when"] did you read that piece of news?
- c. [Noren etxean] geratuko zara lo egiten ?
 whose house-loc stay aux sleeping
 [At whose house] will you stay to sleep ?
- d. [Zelako handia] da Euskal Herria ?
 how big is Basque country
 How big is the Basque Country ?

In fact, it is not clear that the *wh*-phrases in (101) are in any specifier position at all; cf. *nori, noizko*.

Second, Artiagoitia (1992) argues that *wh*-phrases inside relative clauses³⁵ may pied-pipe the entire syntactic island (the complex noun phrase) in which they are contained without occupying the *spec*(C) position of the relative clause, which is filled by an empty operator:

- (103) a. *Norentzat_i desagertu da [t_i egin duzun pastela] ?
 who-ben disappear aux make aux-comp cake
 For whom did [the cake I made t] disappear ?
- b. [Op_i norentzat t_i egin duzun pastela] desagertu da ?
 [The cake I made for whom] disappeared ?

Proof that the *wh*-phrase is *in situ* comes from the fact that the answer to (103b) must recapitulate the entire island, which would not be the case if the *wh*-phrase itself were in *spec*(C) (cf. Pesetsky's 1987 *Felicitous Principle*)³⁶:

- (104) a. ?? Asierrentzat b. Asierrentzat egin dudan pastela...
 For Asier The cake that I made for Asier...

By the same token, the answer to questions (100b) and (101b/d), where *wh*-phrases have pied-piped the entire NC to the matrix "*spec*(C)" in Ortiz de Urbina's terms, must indeed recapitulate the entire NC, which follows if the *wh*-elements do not occupy a *spec*(C) position inside the NC:

(35) In relative clauses, INFL does not assign its *f*-feature [+operator] to *spec*(I) and moves to COMP (relative clauses are obligatorily verb/complementizer final). As a result, *wh*-phrases may remain *in situ* and need not be adjacent to INFL (although scrambling inside the relative clause is generally possible). This is confirmed by sentences which contain more than one argument/adjunct besides the relativized DP (cf. Artiagoitia 1992b):

- ia. (?) Exte honetan norekin bizi den mutila gusta-tze-n zaizu?
 house this-loc who-com live is-comp guy like-TE-loc aux
- b. (?) Norekin etxe honetan bizi den neska gustatzen zaizu?
 [The guy that lives with whom] do you like ?

(36) "A felicitous answer to a *wh*-question consists of a phrase structurally identical to the *wh*-phrase whose index is immediately dominated by the COMP [*spec*, Comp, X.A.] of the question at LF" Pesetsky (1987: 114).

- (100b) [Zer ikastea] erabaki du Ainhoa ?
[Learning what] has Ainhoa decided on ?
- (105) a. ??Fisika b. Fisika ikastea (cf. (99a))
 Learning physics
- (101b) [Zer ikustéak] erakartzen zaitu ?
[Seeing what] attracts you ?
- (106) a. ??Bugsy b. Bugsy ikustea (cf. (100a))
 Seeing Buggy
- (101d) [Zer edatean] joan zara etxerantza ? [
Upon drinking what] have you headed home ?
- (107) a. ??Gáragardo bat b. Gáragardo bat edatean (cf. (100c))
 Upon drinking a beer

These two tests suggest that the occurrence of *wh*-elements inside NCs and the possibility of pied-piping are independent of the existence of a CP constituent³⁷.

Third, further evidence for the absence of a *spec*(C) in NCs is provided by the behavior of the reason adverbial *zergatik* 'why'. Based on work by Kayne, Rizzi (1990) has convincingly argued that reason adverbials are directly generated in *spec*(C) (and not inside VP/IP) and bind no variable. Therefore, the possibility of having a reason adverbial in a given constituent will indicate the existence of a CP node. The data show that reason adverbials are barred from NCs, whether direct extraction or pied-piping is involved. This contrasts with tensed CPs:

- (108) a. Zergatik_i erabaki duzu [t_i joango zarela oporretan] ?³⁸
 why decide aux go aux-comp vacation-loc
 Why_i did you decide [t_i that you will go on vacation] ?
- b. [(Oporretan) zergatik joango zarela] erabaki duzu ?
 [That you will go (on vacation) why] did you decide ?
- (109) a. *Zergatik_i erabaki duzu [t_i joatea oporretan] ?
 go-TE-art
 Why did you decide (on) [t going on vacation] ?
- b. *[(Oporretan) zergatik joatea] erabaki duzu ?
 [(on) going (on vacation) why] did you decide ?

Therefore, I conclude that no justification for *spec*(C) in NCs; instead, *wh*-phrases remain in situ and may trigger pied-piping. Apparently, they do not even move

(37) In fact, the data in the text show that *wh*-elements that trigger pied-piping need not be in a specifier position *per se*. As for the direct extraction out of complement NCs (cf. 100a), the natural assumption is that this takes place through *spec*(D).

(38) (108a) is perhaps hard to process, but the reason adverbial may indeed refer to the embedded clause in the appropriate context:

- i. Erabaki dut [oporretan joango naizela ez oporrak behar ditudalako, ezpada ugazaba jasanezina delako].
I decided [that I'll go on vacation not because I need one, but because I can't stand my boss]
- ii. Zergatik erabaki duzu joango zarela oporretan ?

to spec(D) since this, in principle, might predict that they could satisfy the subcategorization of [+WH] verbs, which is not correct³⁹. As noted earlier, spec(D) is merely a "escape hatch" for successive cyclic movement out of NCs.

2.5.2. On apparent V-2 phenomena as V-I-C movement

The status of operator movement in the grammar of Basque is far from being a settled issue (cf. Eguzkitza 1986, Uriagereka & Laka 1987, Ortiz de Urbina 1989, Laka 1990, Uriagereka 1992 and chapter one, sections 1.3.3-1.3.5). In what follows, I will limit myself to pointing out that the obligatory adjacency between operator/verb is in fact a tensed clause phenomenon, which does not carry over to tenseless CPs and NCs. I will also suggest that analyzing apparent V-2 phenomena in NCs as V-I-C movement triggered by operator-like elements is actually incompatible with a CP analysis of these structures. In descriptive terms, wh-phrases in tensed clauses require that the verb be adjacent to the operator; as explained in section 2.5.1 above and chapter one, successive cyclic movement triggers V-preposing for every embedded verb, which Ortiz de Urbina analyzes as V-I-C movement; this appears to suggest that every embedded verb is second with respect to every wh-trace:

- (110) a. Nora joango da Ainhoa bihar
 where go aux tomorrow
 b. * Nora Ainhoa joango da bihar?
 Where will Ainhoa go tomorrow?
 c. Nora_i esan duzu [t_i joango dela Ainhoa bihar] ?
 say aux go aux-comp
 d. * Nora_i esan duzu [t_i Ainhoa bihar joango dela] ?
 Where did you say that Ainhoa will go ?

Uriagereka (1992) has shown that deriving the wh-element/verb adjacency from V-I-C movement in (109) and the like is problematic in many respects (e.g. in terms of learnability) because it relies on the controversial assumption that COMP is initial in Basque (see also chapter one; cf. note 14). The paradigm in tenseless clauses is different. As noted by Laka & Uriagereka (1987), the adjacency between a wh-phrase and the verb is not obligatory in tenseless indirect questions:

- (39) Here are the data:
 i. * [Zer ikustea] erabaki dugu ii [Zer ikus] erabaki dugu
 We decided what seeing We decided what to see

Actually, that Wh-phrases do move to the highest specifier position of the nominalized clause in the pied-piping cases and yet do not violate Rizzi's (1991) *Wh-Criterion* is the last position adopted by Ortiz de Urbina (1992, 1993). In his analysis, a Wh-phrase in the SPEC position may transmit its [+wh] feature to the XP that immediately dominates the Wh-phrase; then the phrase in SPEC gets marked [-wh] and no violation occurs. This proposal has desirable consequences and raises problems that I cannot address here. My own intuition is nevertheless that the wh-phrases that cause pied-piping in Basque NCs (and also in some tensed clauses) are *in situ*; the possibility of the [+wh] to percolate up to DP is perhaps related to the fact that the complex V-N moves to DET (and V-I always amalgamates with COMP since complementizers are bound morphemes).

- (111) a. Erabaki dugu [nork txerria hil]
 decide aux who-E pig kill
 b. Erabaki dugu [nork hil txerria]
 We decided (on) who to kill the pig
- (112) a. *? Erabaki dugu [nork txerria hilgo duen]
 who-E pig kill aux-comp
 b. Erabaki dugu [nork hilgo duen txerria]
 We decided who will kill the pig

The contrast between the (a) and the (b) examples above crucially shows that the obligatory adjacency between operators and verbs is a property of finite clauses; or more specifically, of finite INFL. The interesting question is what happens with NCs. These cannot satisfy the subcategorization of [+WH] verbs, which follows from my analysis since they lack a spec(C). When direct extraction takes place, the trace of the wh-element does not require immediate adjacency to the verb:

- (113) a. Nora/ze eskolatara erabaki duzu [t seme-alabak bidaltzea] ?
 where/which school-adl decide aux children send-TE-art
 (cf. (110c))
 b. ? Nora/ze eskolatara erabaki duzu [t bidaltzea seme-alabak] ?
 (cf. (110d))⁴⁰
 Where/ to which school did you decide (on) [sending your children t] ?

Furthermore, nominalized clauses containing wh-phrases that pied-pipe the entire DP need not be adjacent to the verb (although adjacency is more common), as long as they appear in the canonical/unmarked order (S-IO-O-V):

- (114) a. [Asierrek txokolatea *nori* ematea] espero duzu?
 -E chocolate who-D give-TE-art expect aux
 b. [Asierrek *nori* txokolatea ematea] espero duzu ?
 c. *? [*Nori* Asierrek txokolatea ematea] espero duzu ?
 d. *? [*Nori* txokolatea Asierrek ematea] espero duzu ?
 Who do you expect [Asier's giving the chocolate to t] ?

What is more, if the remaining DPs are extraposed/dislocated to the right, the wh-word/nominalized verb adjacency gives raise to ungrammatical sentences:

- e. *? [*Nori* ematea Asierrek txokolatea] espero duzu ?

This actually follows from the DP analysis proposed in this chapter and the proposal made in chapter one with respect to the properties of INFL in Basque: given that no INFL node is present in NCs, I predict that no element may move to a potential spec(I) position to receive the feature [+operator] and hence be adjacent to the verb in INFL. Ortiz de Urbina (1989: 172) provides a possible counterexample to this generalization, where a pied-piped NC is ungrammatical:

(40) (113b) is marginal but slightly better than example (114e) below or (71) of chapter one (taken from de Rijk 1969).

- (115) a. [Itsasoko uretan azkenez *zer* murgiltzean] larritu ziren marinelak?
 sea-KO water-loc finally what submerge get-upset aux sailors
 (adapted from O.de U.'s (65i))
- b. * [Zer itsasoko uretan azkenez murgiltzean] ... ?
 (adapted from O.de U.'s 65ii)
 [Upon what finally submerging in the waters of the ocean] did the sailors get upset ?

I agree with the judgement, but I rather suggest that (115b) is ungrammatical not because the verb is not adjacent to the wh-element but because of the presence of the adverb *azkenez* 'finally', which alters the underlying order. In fact, once we remove it, the pied-piped DP displays the unmarked order, and the sentence is grammatical:

- (116) [*Zer* itsasoko uretan murgiltzean] larritu ziren marinelak ?
 [Upon what submerging in the waters of the ocean] did the sailors get upset?

Another problem faced by the V-I-C analysis of V-2 phenomena with regard to (115b) is that if NCs were indeed CPs as suggested in tree (39), repeated here for convenience, where COMP is assumed to be final in NCs, the COMP position would be occupied by the postposition *an* (cf. (45b) above):

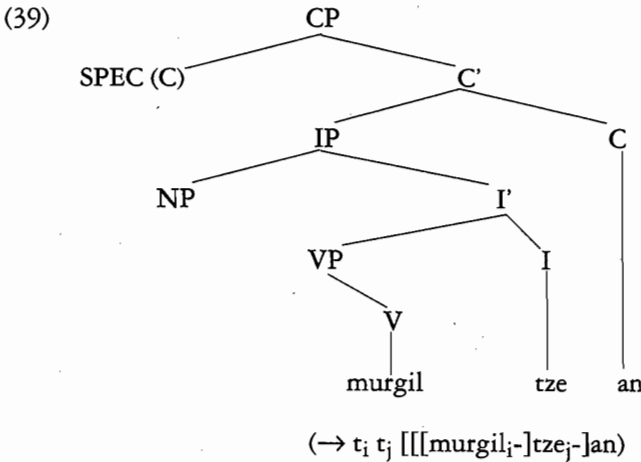

Hence there would be no "landing site" for *murgiltzean* 'upon submerging' since the amalgamated form already contains the COMP position itself (namely the morpheme *-an*). The asymmetry introduced by Ortiz de Urbina in analyzing tensed CPs (COMP precedes IP) and nominalized clauses (IP precedes COMP) and the fact that all elements appearing in COMP in his account are bound morphemes make it impossible to maintain that the (optional) order *wh-phrases* + *nominalized verb* necessarily corresponds to the constituents *spec(C)-COMP* respectively, unless the elements in the final position of NCs (postpositions and the article) are assumed not to be in COMP and the existence of a CP node over the NC is stipulated. This in turn entails that the COMP/CP analysis of NCs is misguided and should be abandon-

ed. The preceding discussion suggests then a) that the obligatory operator-verb adjacency in Basque should be treated as a tensed clause phenomena; and b) that analyzing optional V-2 phenomena as V-I-C is untenable in a sentential analysis of NCs. As for the ungrammaticality of (114c/d) I have no definite explanation to offer at this point; it could be the case that the trace of the "dislocated" wh-element fails to be antecedent-governed/bound by the wh-phrase itself due to the presence of the intermediate (possibly topicalized) DPs. This situation, of course, does not arise when the wh-phrase remains in situ (112a/b).

2.5.3. Summary

So far I have shown that the morpheme *te* in Basque must be treated as nominal in both its "derived" and "syntactic" use, and that this dual behavior is predictable from its lexical entry in (70), repeated here for convenience, if we adopt Emonds's hypothesis that grammatical formatives may be inserted at D-S or after S-S (in their way to PF):

- (70) a. $te]$, N, +V ___ $\left\{ \begin{array}{l} ((V:+ACTIVITY)) \\ N = [-completed] \end{array} \right\}$
 b. $n],i],tu]$, N, [+completed], +V ___

After rejecting the sentential analysis of Basque nominalized clauses on both empirical and theoretical grounds, I have also argued that the existence in Basque of constituents which display external DP distribution and have internal clausal structure is a legitimate option in UG made possible the X-Bar schema proposed in chapter one along the lines of Lieber (1992) and the *Empty Head Transparency* generalization, which allow a selectionally dominant head to prevail over the structural head of an XP if the latter (= structural head) is empty at a given stage in the derivation. I have also shown that the array of INFL-like properties found in Basque NCs (namely, clausal subjects, gapping, present moment interpretation) correlate with the existence of V-N to D movement, impossible in English on independent grounds. Finally, two apparent sentential properties of Basque NCs were discussed: pied-piping and operator-verb adjacency (V-2) phenomena. I established that the possibility of pied-piping in Basque is in fact a property of virtually *all maximal phrases* and hence cannot be used as a constituency test. As for V-2 phenomena, I claimed that the adjacency between operators and the verb is only *an obligatory property of finite clauses* (a reflection of Spec-Head agreement between spec(I) and INFL), which does not extend to NCs and non-finite clauses. Therefore, surface operator-verb adjacency cannot be used as a diagnostic for sentencehood.

2.6. Spanish nominal infinitives

2.6.1. Analysis

In this section I will illustrate how the Spanish nominal infinitives studied by Plann are also a language particular instantiation of the dual insertion possibility for grammatical formatives. Plann (1981) has conclusively shown that there are two kind of nominal infinitives in Spanish: a) those which have the internal structure of

any other derived nominal (adjectival modification, prepositional complements, etc.); and b) those which have the internal structure of a clause (adverbial modification, DP complements, and so on) but have external noun phrase distribution; I will call the latter nominalized (infinitival) clauses:

- (117) a. El (dulce) lamentar de los pastores es cosa de Carlos
The (sweet) complaining of the shepherds is Carlos' thing
b. El constante murmurar de palabras obscenas es ofensivo
The constant murmuring of obscene words is offensive
- (118) a. El contemplar el lago distraadamente me relaja
Looking at the lake absent-mindedly makes me relax
b. El murmurar palabras obscenas constantemente es ofensivo
Murmuring obscene words constantly is offensive

Plann gives about a dozen tests that distinguish the two kinds of nominals as well as several tests that distinguish the latter kind from simple infinitival clauses dominated by an S' (=CP) node. She assumes that the infinitive is of category N in the first kind of nominal infinitive; as for the second kind of nominal infinitive, she assumes that S' is a sister to an empty N head:

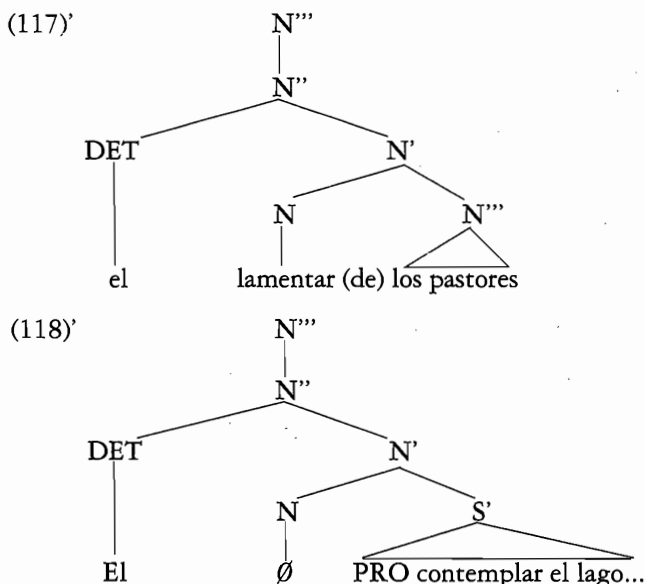

That the first nominal infinitive is indeed nominal seems uncontroversial; I will take this to be a simple case of the well-known morphological process of zero derivation. As Plann herself notes, this kind of nominalization is restricted to a handful of verbs that otherwise lack a derived nominal. Furthermore, most of her examples involve, loosely speaking, activity oriented verbs like *chismear* 'gossip', *venir* 'come', *despertar* 'wake up', *tiritar* 'shiver', *murmurar* 'murmur', *correr* 'run', *sollozar*, 'cry'... (i.e. mainly transitive, unergative and motion verbs). It can be shown that

stative and psych verbs cannot have a zero derived nominal even if they lack any other form of derived nominal:

- (119) a. *? El constante quedarse en casa de Ainhoa
Ainhoa's constant staying at home
b. *? El dulce yacer en la cama de Ainhoa
Ainhoa's sweet lying in bed
c. *? El (despiadado) asustar de niños
The merciless frightening of kids

Hence I propose the following provisional entry for the zero morpheme (call it *n*); not surprisingly, the restrictions on the verbal stems that may undergo *n*-suffixation in the base are parallel to those found for English *ing* and Basque *te*:

- (120) $n (= \emptyset)$], N, +V___ {V: +ACTIVITY}

Plann's assumption that CPs can be sisters to an empty nominal head is problematic since the nature of the empty nominal is left unexplained: what kind of complements other than CP may it have? what are its properties? what licenses it? Here I will propose that the zero morpheme at work in the first kind of nominal infinitives can also function as an inflectional morpheme just like English *ing* and Basque *te*. In this way we can collapse both nominal infinitives under the same zero suffixation process, retaining Plann's original insights. Since the second instance of the morpheme is in fact unconstrained and not restricted to any verb class, it follows that it will be subject to late insertion. Therefore, (120) has to be modified accordingly:

- (121) $n (= \emptyset)$], N, +V___ ({V: +ACTIVITY})⁴¹

The two nominal infinitives have then the following structures:

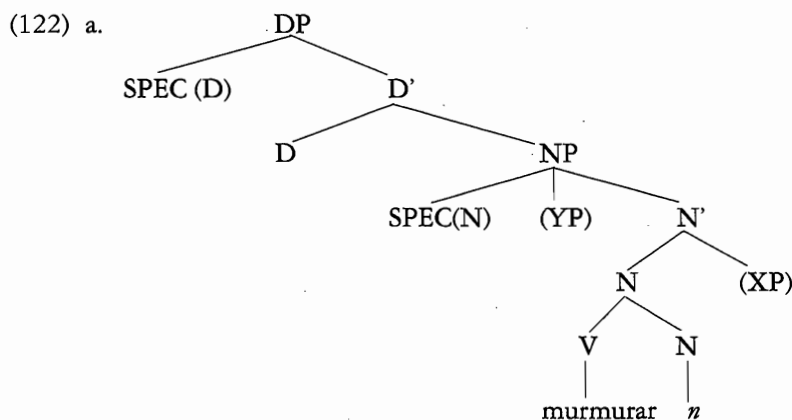

(41) The alternative would be to consider the infinitival ending *r* a morpheme of category N. I believe this is wrong because the occurrence of non-nominal infinitives (bare Vs) would be left unexplained.

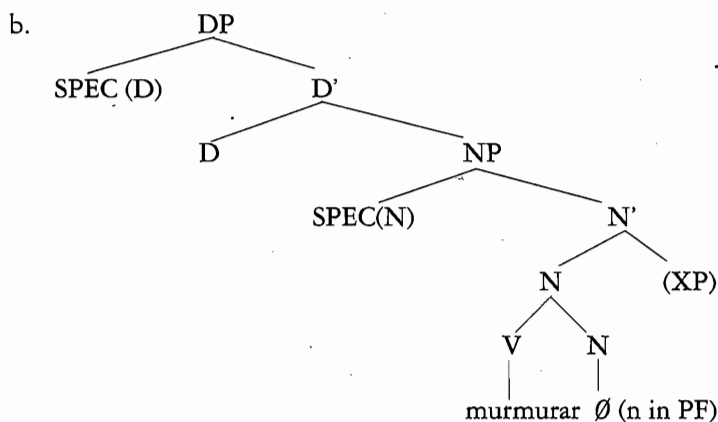

[Needless to say, even though the morpheme *n* is lexically null, (122b) is aimed at distinguishing the stage prior to the insertion of the zero morpheme itself].

The second kind of nominal infinitive has basically the same structure as English DP gerunds and Basque nominalized clauses. Its behavior with respect to the possibility of lexical subjects is interesting in this respect: most speakers seem to reject lexical subjects in structures like (122b):

- (123) El correr (*Juan y Tomás) rápidamente por las calles no llamaría la atención (Plann's 64a)
 Juan and Tomas running fast on the streets would not draw attention

This shows that the conditions for case-assignment are not met in Spanish nominalized clauses; "nominative" case appears to be a marked option (cf. Basque). And "genitive" case (subject preceded by the preposition *de*) is not available either, possibly because, unlike in English, D does not assign case in Spanish⁴².

However, some speakers do seem to accept lexical subjects in nominalized clauses according to Yoon and Bonet-Farran (1988):

- (124) El cantar yo La Traviata traerá malas consecuencias
 I singing La Traviata will have bad consequences

Unfortunately, they do not discuss whether this is possible in all positions in which nominalized clauses may occur. In fact, the observation regarding the presence of lexical subjects in clausal infinitives is that they seem to display anti-ECP effects (Olarrea 1991): they occur in the subject position (usually of the copula *ser* 'be'), and in adjunct position as complements to certain prepositions. Yoon and Bonet-Farran's discussion of lexical subjects in clausal infinitives agrees for most part

(42) Nominalized infinitival clauses in Spanish cannot have a present moment reading either:

i. *El correr ahora mismo es una sorpresa
 Running right now is a surprise

(i) cannot be paraphrased as "that somebody is running right now is surprising" but rather has a future reading ("that someone might be/start running in a moment is surprising").

with Olarrea's paradigms⁴³. But they fail to discuss whether the same generalization is true of nominalized infinitival clauses, although the answer seems to be affirmative:

- (125) *Esto prueba el cantar tú La Traviata muy bien⁴⁴
This proves you singing La Traviata very well

I will not attempt here to provide an account of the restricted distribution of lexical subjects in infinitives, whether they are dominated by a DP or a CP nodes (but see Olarrea 1991); obviously both cases seem to fall under the same generalization. Rather, I will suggest that nominative case-assignment in Spanish NCs is licensed in a similar way to Basque. Recall from the discussion in section 2.4 that in Basque NCs D may assign nominative case (a cover term for ergative/absolutive) just in case the verb is the L-head as S-S; this is possible because the article in Basque is a bound morpheme and head-movement of the verb into the D position is obligatory. Obviously, this is not the case in Spanish. But let us suppose that *abstract incorporation*, i.e. head-coindexing, la Baker (1988) is available as a marked, somewhat marginal option, possibly because of the clitic-like nature of the article:

- (126) El_i murmurar_{i-n} palabras obscenas ...

This predicts that gapping of D-V-N should be possible in the same fashion [[V]-[I]] gapping is, which is correct:

- (127) a. El dar de comer al hambriento y [\emptyset] ([\emptyset] = D-[V-N]) de beber al sediento es precisamente lo que el Papa no hace
Giving to eat to the hungry and to drink to the thirsty is precisely what the Pope doesn't do
b. El dar yo de comer al hambriento y [\emptyset] tú de beber al sediento es otra cursilada de Carlos
"I giving to eat to the hungry and you to drink to the thirsty is another nonsense of Carlos"

This analysis also predicts that any intervening head should block head-coindexing and, therefore, the possibility of D's assigning nominative case. This seems correct too; the presence of the adjective *mero*, the only adjective allowed in these nominal infinitives, blocks gapping and case-assignment:

- (128) a. *El mero dar de comer al hambriento y [\emptyset] de beber al sediento...
Mere giving ...

(43) Actually they assume that some factive verbs may have CP infinitives with lexical subjects; but the infinitive has to be an auxiliary or modal verb:

i. Esto prueba ser tú el que mató a la víctima
This proves you to be the one that killed the victim

Olarrea (p.c.) and I strongly disagree with this judgement.

(44) I find (ii) terrible, far worse than (i) in note (43):

ii. *Esto prueba el ser tú el que mató a la víctima
This proves you being the one that killed the victim.

- b. *El mero cantar tú La Traviata traerá malas consecuencias
You mere singing...

It can be concluded then that the (marginal) possibility of nominative subjects in nominalized infinitival clauses in Spanish is only possible as a result of abstract incorporation, a process similar to V-N to D movement observed in Basque NCs⁴⁵.

2.6.2. Extraction from English, Basque and Spanish NCs

Finally, another systematic difference between Spanish on the one hand and English/Basque on the other must be considered. English DP gerunds allow extraction if the spec(D) position is not filled; if it is filled, the familiar subjacency violations result. In Basque, on the other hand, subjects do not occupy the spec(D) position, so extraction is always possible:

- (129) English
a. What_i does Suzzane hate [t_i smoking t_i] ?
b. * What_i does Suzzane hate [Mary's smoking t_i] ?

- (130) Basque
Zer_i gorrotatzen du Suzzanek [t_i (Ainhoak) t_i erretzea] ?

I have adopted Rizzi's version of the ECP throughout and assumed that head-government is a PF condition. Consequently (129b) does not violate the ECP since the noun *smoking* at PF head-governs the trace; crucially, the latter is bound by *what*. Only subjacency is at work here (cf. Stowell 1989). Interestingly enough, extraction from Spanish nominalized infinitival clauses is always ungrammatical (whilst the corresponding simple infinitival clauses do allow extraction):

- (131) a. Susana odia [el fumar marihuana]
Susana hates smoking marihuana
b. * Qué_i odia Susana [el fumar t_i] ?
What does Susana hate [smoking t] ?
cf. c. Qué_i odia Susana [fumar t_i] ?
d. [El leer el periódico por la mañana mientras desayuno] me encanta
Reading the newspaper in the morning while I have breakfast thrills me
e. * Qué_i te encanta [el leer t_i por la mañana mientras desayunas] ?
What does [reading t in morning while you have breakfast] thrill you ?
cf. f. Qué_i te encanta [leer t_i por la mañana mientras desayunas] ?

(45) Yoon and Bonet-Farran (1988) give one example of a nominalized infinitival clause with a genitive subject and then claim that the three variants of nominalized infinitival clauses (the subjectless ones, those with nominative subject, and this third type) are the exact equivalent of English PRO-ing, ACC-ing and POSS-ing. This is suspect; I have found no speaker that considers NICs with genitive subjects grammatical. Their alleged three-way paradigm seems forced upon Spanish by the English paradigm. This is corroborated by the fact that the Spanish data are in many ways empirically different from English: NICs with nominative subjects occur only in some dialects, and even then, they cannot occur in complement position.

These extractions from Spanish nominalized infinitival clauses are excluded despite the fact that extraction of objects from DPs headed by the article is otherwise acceptable (when no subject is present) in the same situations (complement to a verb, subject of emotive verbs):

- (132) a. Este es el único concursante [del que]_i; he visto [la foto t_i]
(Mallén's 1989 (31))
This is the only contestant of whom I have seen [the picture t_i]
b. (?) De qué actriz_i odias [la foto t_i que has visto en el periódico]?
Of which actress do you hate [the picture t_i you saw in the newspaper]?
c. (?) De qué actriz_i te gusta [la foto t_i que has visto en el periódico]?
Of which actress is [the picture t_i you saw in the newspaper] pleasing to you?
d. (?) De qué cuadro_i te gusta [la reproducción t_i (que viste en el museo)]?
Of which painting is [the reproduction t_i (that you saw at the museum)] pleasing to you?

Leaving aside the potential marginality of the examples in (132) (which are far better than the cases of extraction from nominalized infinitival clauses in any case), (131b,d) clearly contrast with the corresponding English and Basque data. One might try to pursue some *ad hoc* strategy and suggest that Spanish nominalized infinitival clauses only project to the D'-level and lack an escape hatch. However, the account for this difference is straightforward in terms of the assumptions made in this chapter: the obvious difference between English and Basque on the one hand and Spanish on the other, is that the *nominal suffix is lexical* in the former languages, but *null* in the latter. Since these morphemes, by hypothesis, are not present until PF, the level where the (head-government requirement of the) ECP applies, the reason for the ungrammaticality of (131b,d) is evident: in Spanish the null morpheme *n* cannot head-govern the original trace of the extracted wh-element at PF because null elements lack any governing capacity. This situation does not arise in English and Basque at PF, because both *ing* and *te* are present at that level and hence do govern the object trace. No explanation for this contrast could be simpler. The zero-suffixation account of both Spanish nominal infinitives also makes a secondary prediction: extraction of genitive objects out of derived nominal infinitives should also yield an ECP violation (zero morphemes do not head govern); this is the opposite of what happens in any other derived nominal, where the suffix is lexical. The prediction turns out to be correct:

- (132) a. * De qué palabra obscena_i odias/te gusta [el susurrar t_i]?
Of which obscene word do you hate/like [the murmuring t_i]?
b. * De qué persona_i detestas/te gusta [el andar t_i]?
Of which person do you detest/like [the "walking" t_i]?
c. * De qué música_i odias/te encanta [el tocar t_i]?
Of which music do you hate/does [the playing t_i] thrill you?
cf. d. (?) De qué cuadro_i detestas/te gusta [la reproducción t_i (que viste en el museo)]?

Of which painting do you detest/like the reproduction that you saw at the museum ?

- cf. e. (?) De qué edificio_i recomiendas [la *rehabilitación* t_i] ?
Of which building do you recommend [the renewal t] ?

This clear paradigm lends additional support to the zero-derivation account that I have proposed in this section for both instances of nominal infinitives.

2.7. Final remarks

This chapter has proved that the intuition that two basic uses of *te* ("derivational" and "inflectional") are indeed nominal is elegantly captured by the theory of the grammar once we adopt the hypothesis that grammatical formatives may be inserted at two levels (at D-S and after S-S), a fact that is predictable from their lexical entry. I have claimed that the mixed behavior of Basque *te* is just a reflection of the general UG mechanism that allows grammatical formatives that are subject to late insertion to be present in terms of X-Bar theory but absent in terms of government and related modules (case theory) (cf. *Empty Head Transparency* in chapter one); this has been further exemplified by English *ing*, Romance infinitives with the article, and is possibly extendable to Quechua and Turkish nominalizations. In fact we predicted that any language which allows a verb to select +V (or, where appropriate, +V^[F (Aspect)], where F (Aspect) is [+/-completed]) and has a nominal suffix not restricted to a particular semantic class of verbs will exhibit a constituent with external DP distribution and internal clausal structure; case-assignment to the subject will depend on specific parametric choices of the language in question (genitive subjects vs nominative subjects). In pursuing my proposal, I have argued against previous analyses of both English gerunds and Basque nominalized clauses both on empirical and theoretical grounds. On empirical grounds, it was shown that the nominal head hypothesis for NCs correctly predicts the external DP distribution of gerunds and NCs, as well as their internal sentential structure, without any IP and VP projections proper being in fact realized. On theoretical grounds, the proposal made here avoids many *ad hoc* assumptions as to the combinatorial nature of functional categories and neutralized categories, and is consistent with X-Bar theory and the current view of the unique relation between functional and lexical elements (Fukui & Speas 1986, Grimshaw 1991).

3. The so-called perfect participle morpheme in Basque and why it is not (always) perfect and why it is not (necessarily) participial

The purpose of this chapter is relatively modest in scope: to show that the perfect morpheme of Basque, which is usually taken to be the counterpart of the Indo-European "past participle", is lexically specified as a morpheme of category Noun and Adjective, and to argue that all uses of the morpheme, especially its occurrence in the so-called "passive" construction, arise as a result of and are predictable from this dual lexical specification. By deriving the properties of the relevant morpheme from its lexical entry, the differences between it and its Indo-European counterpart studied in Emonds (1989) will become evident. In writing this chapter, I have greatly benefited from Eguzkitza's (1981) and Ortiz de Urbina & Uribe-etxebarria's (1991) insights regarding the Basque "passive" construction. In fact, the dual category approach I have independently pursued here leads me to analyze "passive" structures as tenseless relative clauses, a result which is very similar to the proposals advanced in these two articles. The following discussion assumes Emonds' *Double Lexical Insertion Level Hypothesis* outlined in chapter one that grammatical formatives are inserted at D-S when their insertion is constrained or induced by a purely semantic feature, and after S-S otherwise. If the latter option is chosen, the morphemes remain empty until PF and are inert for government and case by virtue of the *Empty Head Transparency*:

- (1) *Empty Head Transparency*: Under the same X^2 , empty heads induced by subcategorization distinct from the L-head are transparent in the syntax (where transparent = do not govern and do not block government)

The chapter is structured as follows: section 3.1 studies the formation of derived nominals and derived adjectives, which I show results from the D-S insertion of the perfect morpheme. As will become clear, this derivational process is invariably associated with the absorption of the verb's internal argument. Section 3.2 focuses on the licensing of perfect nominalized clauses of the type studied in the previous chapter; some instances of it in adjunct positions are discussed. Section 3.3 analyzes some occurrences of the perfect morpheme in two different types of predicate phrases, which I argue are both PPs. I claim that these predicative phrases are selected as $V^+ [+completed]$ and P respectively, but are licensed because of the N(ominal) value of the perfect morpheme, whether D-S or post S-S insertion is involved. Finally, section 3.4 tackles the issue of the so-called "passive construction" in Basque and shows that the latter is best analyzed as a sentence which contains a subject, a copula and a complex NP (where the noun is zero) that includes a tenseless relative formed with the perfect morpheme (the N value). Based on Emonds's insights regarding the relationship between the passive and the perfect morpheme in Indo-European (which he considers essentially the same morpheme), I derive the lack of a true passive in Basque from the absence of the absorption feature on the perfect morpheme when the latter is inserted after S-S (in its way to PF).

3.1. The perfect morpheme in derived morphology

There are three *basic* perfective endings in Basque: *n*¹ (which alternates in some verbs with *o*), *i*, and *tu*. The first two are native Basque morphemes, whereas the latter is undoubtedly a borrowing from Latin (cf. Lafon 1943, Irigoyen 1985 and references therein); only *tu* is presently a productive morpheme (cf. (2d))²:

- (2) a. *egon, jasan, jaso, eman, ekin, etzan, entzun, egin, eten,...*
 stayed, suffered, lifted, given, engaged oneself in, lied, heard, done,
 interrupted, ...
- b. *ikusi, etorri, erori, ikasi, eskeini, irabazi, irakurri,...*
 seen, come, fallen, learned, offered, won, read, ...
- c. *garbitu, geratu, dimititu, askatu, begiratu, burrukatu, zoratu,*
 cleaned, remained, resigned, liberated, looked at, ...
fought, gotten crazy ...
- d. Eng. flash → Basque *flashatu*, **flashan*, **flashi*
 Fr. tromper → Basque *tronpatu*, **tronpan*, **tronpi*
 Sp. gustar → Basque *gustatu*, **gustan*, **gustai*

As a first approximation, it is evident that this perfective ending forms both derived adjectives (cf. (3)) and derived nominals (cf. (4)):

- (3) a. Berebil *erabil-i-ak* / berebil zaharr-ak
 car used-art old
 Used cars / old cars
- b. Denbora *gal-du-a* / denbora urri-a
 time wasted-art scarce-art
 Wasted time / scarce time
- c. Amets *apur-tu-ak* / amets urdin-ak
 dream broken-art blue
 Broken dreams / blue dreams
- d. Urrats *desbidera-tu-ak* / urrats handi-ak
 step deviated-art / big-art
 Strayed steps / big steps
- (4) a. Kontutan har aitonaren *esa-n* zaharrak
 account-loc take grandpa-gen saying old
 Take into account grandpa's old sayings (cf. *esan* = 'to say')
- b. Guk *irabaz-i* handiak atera ditugu
 we gain big-art accomplish we-have-them
 We have had big gains (cf. *irabaz(i)* = 'to gain')
- c. Ainhoak *eritz-i* aldakorrak ditu
 opinion variable has-them
 Ainhoa has variable opinions (cf. *eritz(i)* = 'to opine')

(1) *n* is not really the perfect ending but rather part of the bare verbal root. The perfect ending for verbs whose root ends in *n* is \emptyset . Nonetheless, following Lafon (1943), and for ease of exposition, I will refer to *n* as a perfect ending.

(2) In the Southern Basque Country, the participle is also the citation form of a verb.

- d. Bota egiozu *begira-tu* arin bat gutun honi
 have aux look quick one letter this-D
 Have a quick look at this letter (cf. *begira(tu)* = 'to look at')

Section 3.1.1. below concentrates on the examples of deverbal derived adjectives in (3); section 3.1.2, in turn, analyzes the examples of deverbal derived nouns in (4).

3.1.1. *On the derived adjectives*

Unlike in Indo-European languages, deverbal adjectival modification inside noun phrases of the type exemplified in (3) is rare in Basque and sounds "foreign-like" in many cases. A much more common strategy is to resort to adnominal modification with a tenseless relative clause, as can be seen in (5), where tenseless relatives are paraphrasing and replacing the adjectives of (3):

- (5) a. [[pp Erabil-i-ta-ko] berebilak] (cf. (3a))
 use-perf-TA-KO cars
 Used cars ("cars that someone [has] used")
 b. [[pp Gal-du-ta-ko] denbora] (cf. (3b))
 waste-perf-TA-KO time
 Wasted time ("time that someone [has] wasted")
 c. [[pp Apur-tu-ta-ko] ametsak] (cf. (3c))
 break-perf-TA-KO dreams
 Broken dreams ("dreams that [have] broken/ someone [has] broken")
 d. [[pp Desbidera-tu-ta-ko] urratsak] (cf. (3d))
 deviate-perf-TA-KO steps
 Strayed steps ("steps that have deviated/turned aside")

I will return to these relative clauses later in section 3.2.1.2. The *rareness* of the deverbal perfect adjectives in Basque squares well with the fact that the only productive morpheme to form derived adjectives is the borrowed (and more "recent") affix *tu*.

When adjectives are derived using the perfect morpheme *en* in English, it is generally assumed that the morpheme suppresses the external argument. Not surprisingly, many authors (cf. Bresnan 1982, Levin and Rappaport 1986, Grimshaw 1990, Zubizarreta 1987) refer to these adjectives as "adjectival passives", distinguishable from "verbal passives" by several tests discussed extensively in Wasow (1977): a) like regular adjectives, adjectival passives may undergo *un* prefixation even with verbs that do not otherwise accept the prefix *un*, but verbal passives cannot; b) adjectival passives can be complements to verbs that generally take AP complements such as *seem*, *remain*, *sound*, etc; verbal passives can only be complements to *be* and *get* (cf. Emonds 1989); c) adjectival passives can be in attributive position just like regular adjectives but verbal passives obviously cannot, and so on. Both Levin and Rappaport (1986) and Grimshaw (1990) assume that adjectival passives are derived from verbal passives. Obviously, the term "adjectival passive" is a misnomer since

“adjectival passives” exist that are derived from unaccusative verbs (though not from unergative verbs), a fact noted at least since Bresnan (1982: 21-32):

- (6) a. swollen feet, a failed attempt, a fallen dictator, ...
 b. Your feet seem swollen
- (7) a. *a run person, *a coughed person, ...

Levin and Rappaport (1986) suggest that the source of participial adjectives in (6) is perhaps the perfect participle (cf. their note 36), and that the contrast (6)-(7) should be expressed in terms of the unaccusative/unergative distinction rather than be determined by a “thematic condition” (as in Bresnan 1982); but they stop short of offering a definite solution. Grimshaw (1990) maintains the dual source for participial adjectives: unaccusatives may form adjectives of the “passive” kind because the process simply adds an external argument R to the argument structure of the derived adjective; this will be impossible for unergative verbs on the assumption that they already have an external argument:

- (8) a. melt ((x)) → melted (R (x)) b. (x (y)) -/→ (R (x (y)))

Adjectival passives of transitive verbs are, on the other hand, derived from the corresponding verbal passive, as in Levin & Rappaport (1986) [the verbal passives already contain a suppressed argument]. The interesting point about Basque deverbal perfect adjectives is that they follow the same pattern as English despite the fact that there is no verbal passive in Basque (cf. Eguzkitza (1981)) as we shall see below (cf. 2.4.2.): in other words, there are adjectives which derive from unaccusative verbs (e.g. 3d above), and those derived from transitive verbs also have a “passive” meaning³:

- (9) a. Denbora *joa-n-a*
 time go-perf-art
 (The) gone/past time
- b. Arbola *eror-i-a*
 tree fall-perf-art
 (The) fallen tree
- c. Pitxer *ibil-i-a*
 pitcher walk-perf-art
 (The) “walked”/used pitcher
- d. berebil *erabil-i-ak*
 (= cars that have been
 used/somebody has used) (=3a)

This suggests that Levin & Rappaport’s and Grimshaw’s approach to adjectival “passives” is untenable (at least for Basque). Instead, I will follow Zubizarreta’s (1987) insight that adjectival (“passive”) participle formation is independent from verbal passives and that it should predict that unaccusatives will also form adjectives of this kind. She reduces the process to a change in category (V→A) and the insertion of the semantic feature STATE, borne by the resulting adjective. In the terminology used throughout this article, I therefore assign them the following provisional lexical entries:

(3) There are, however, two well-known exceptions:

- i. Hauek haur *ikas-i-ak* dira
 these kid learned are

“These are learned kids” (=smart kids)

- ii. Ainhua pertsona *irakurr-i-a* da
 person read

is Ainhua is a [well-] read person

Ikasi may also translate as *study*. Both verbs take optional DP complements. I have no explanation for these two exceptions. Note that English also has a similar exception.

- (10) a. English:
en, A, +V____, STATE {V = +ACTIVITY/+MOTION}
- b. Basque:
i, *n*, A, +V____, STATE {V = +NATIVE, +ACTIVITY/+MOTION}
tu, A, +V____, STATE {V = +ACTIVITY/+MOTION}⁴

According to Zubizarreta (cf. also Levin & Rappaport 1986), no mention of specific θ -roles or argument structures is needed in the rule; on the assumption that adjectives do not take internal arguments (i.e. that unaccusative adjectives don't exist)⁵, it follows that the internal argument of the verb will become the external one after adjective formation; if the verb is transitive, the external argument will be incorporated into the predicate. Crucially, this "absorption" of the external argument (when there is one) presupposes the existence of a level of representation independent of subcategorization proper that includes "a set of structured predicate-argument relations" (Zubizarreta 1987: 7)⁶.

Since in chapter one (1.2.2) I have explicitly rejected the notion that such a level plays any role in syntax or is to pertinent subcategorization, I implement this restriction at D-S by elaborating (10). I propose to do so by specifying the noun phrase complement to the verb and adopting Emonds's Phrasal Absorption Convention:

- (11) *Phrasal Absorption Convention*: Phrasal Absorption by bound affixes. If β is an affix bound to a lexical category Y^0 , an additional phrasal subcategorization frame +____ α is satisfied by an empty α in positions that would satisfy Y^0 , +____ α ["+ α " in my notation]. In such cases we can say that β absorbs the complement of Y^0
- (12) a. English:
en, A, +V____ + N, STATE {V = +ACTIVITY/+MOTION}
- b. Basque:
i, *n*, A, +V____ + N, STATE {V = +NATIVE, +ACTIVITY/+MOTION}
tu, A, +V____ + N, STATE {V = +ACTIVITY/+MOTION}⁷

(4) (10) includes the restriction that the verb must be +ACTIVITY/+MOTION because not just any unaccusative verb may form a derived adjective; non-motion verbs like *stay*, *lie*, *stand* in English, and *egon*, *etzan*, *izan* in Basque cannot form derived adjectives: *a stood person, *Mary seems stayed at home, ... The feature +NATIVE in (10) simply identifies the set of verbs taking the suffixes *n* and *i* as the core, non-derived and usually oldest verbs of Basque (cf. +/-Latinate in English). It doesn't imply that all verbs taking *TU* are non-native. [e.g. many verbs taking *TU*, even though they are part of the native vocabulary, are derived from nouns/adjectives: *garbi* 'clean' = *garbi-tu* 'to clean', *ikara* 'fear' = *ikara-tu* 'to frighten'. This is virtually never the case with [+NATIVE] verbs].

(5) See Zubizarreta (1987: 10ss) for motivation.

(6) Zubizarreta's approach contrasts with Bresnan's (1982: 23), who views perfect adjective formation as a unified process but makes specific reference to the theme θ -role in the rule. Similarly, although Williams (1981: 92-95) and Di Sciullo and Williams (1987: 57) don't discuss perfect adjectives derived from unaccusatives, they derive adjectival passives by the operation *Externalize (Theme)*. One expects that this operation will also affect unaccusative verbs. The bottom line, though, is that mention of specific θ -roles is involved in the morphological operation, as in Bresnan's account.

(7) Emonds (1989) uses the feature PERFECT, which is "semantic" according to him. I disagree because, as will be argued in chapter four, [+/-perfective] or [completed] are syntactic features. Besides, it is too simplistic to say that adjectival passives have a perfective, "completed", reading:

By (11), we ensure that the adjective formation with *i*, *n*, *tu* is only executed when the verb subcategorizes for a noun phrase (i.e. for transitive and unaccusative verbs) without resorting to the more abstract predicate-argument level^{8,9}.

After discussing the formation of adjectives derived from the perfect morphemes, I now turn to the formation of derived nouns (cf. (4) above).

3.1.2. On the derived nouns

Unlike nominals derived from the morpheme *te* studied in the previous chapter (sec. 2.2) (which may vary from an event to a result reading), nominals that are derived from the perfect morphemes lack argument structure in the sense of Grimshaw (1990) and must all be interpreted as result nominals. Hence, with respect to all the tests proposed in Grimshaw to distinguish event nominals or nominals with argument structure from result nominals, they pattern together with the latter: only ‘possessive’ genitives are allowed, but no object genitive; adjectives like *etengabe* ‘constant’ are ruled out; these nouns may pluralize, they do not accept durative modifiers, etc... (see Grimshaw 1990: ch. 3). As expected, the judgments are reduplicated in the English glosses:

- (13) a. Aitonaren (*istorioen) *esa-n-a*
Grandpa-gen stories-gen say-perf-art
Grandpa’s saying (*of stories)
b. Aitonaren istorioen kondaketa
narration
Grandpa’s narration of stories
- (14) a. *Aitonaren *esa-n etengabe-a*
*Grandpa’s constant saying
b. Aitonaren istorioen kondaketa etengabe-a
Grandpa’s constant narration of stories
- (15) a. Aitonaren *esa-n zaharr-a-k*
Grandpa’s old sayings
b. *Aitonaren istorioen kondaketa (*zahar)-ak
*Grandpa’s (*old) narrations of stories
- (16) a. *Aitonaren *esa-n-ak ordu batez irauñ zuen*
hour one-inst last aux
*Grandpa’s saying lasted one hour

i. The door remained closed during the noon hour

Contra Emonds, (i) doesn’t imply that the ‘closing’ was completed by noon. It simply asserts that the state of the door was all the same during that time.

(8) I am assuming that external arguments are not expressed in subcategorization as in Chomsky (1965) and Emonds (1991), and that unaccusative verbs subcategorize for an object noun phrase.

(9) J. Emonds (p.c.) points out to me that the notation may have to include the subscript on the noun phrase complement to specify it as (obligatorily) null. If so, (12) should be modified as follows:

i. $[j, n], A, +V_N, STATE \dots$ (where N_a = obligatorily null at D-S)

I leave this notational problem open.

b. Aitonaren istorioaren kondaketak ordu batez iraun zuen
Grandpa's narraton of the story lasted one hour

The most widely used nouns of the type illustrated in (4) seem to be derived from the *i/n* morphemes; fewer are derived from *tu*: *erratu* 'mistake'/'mistaken', *begiratu* 'look, glance'/'looked', *heldu* 'adult'/'maturated', *ikutu* 'touch'/'touched'. [In fact, it is not clear whether *erratu* was not borrowed in Basque as a full noun; cf. English *erratum*]. The rest are derived from either *i* or *n*, usually *i*. Furthermore, stative verbs like *egon* 'stay/remain', *etzan* 'lie' do not form a noun. We might express these restrictions as follows:

- (17) Noun derivation with perfect morpheme (tentative)
n], *i*], N, +V___ {V = +NATIVE, +ACTIVITY/+MOTION}¹⁰
tu], N, +V___ {V = +ACTIVITY, +MOTION}

In Grimshaw's framework (1990), the fact that the nouns in (3) are "result" nominals and lack argument structure is expressed by virtue of an argument-structure operation: assign the R(eferential) role to the derived noun (cf. also Di Sciullo & Williams 1987):

- (18) a. esa- V, (x (y (z)))
 say
 irabaz- (x (y))
 win/gain
 b. -n, -i, N(oun) R
 c. esan 'saying' N, (R = y) such that
 x says y (to z) 'gain' N,
 irabazi (R = y) such that x gains y

But once again, this is expressable in the subcategorization frame if we extend "phrasal absorption" to nouns, thus making the argument-structure operation unnecessary:

- (19) Noun derivation with perfective morpheme (replaces (17))
n], *i*], N, +V___ + N {V= +NATIVE, +ACTIVITY/+MOTION}
tu], N, +V___ + N {V= +ACTIVITY/+MOTION}

(19) predicts that the verbs which undergo *n*-, *i*-, and *tu*-nominal derivation must be transitive or unaccusatives (of the motion-type), as desired. By extending the phrasal absorption feature to the nominal value of the perfect morpheme, we capture the fact that constraints on the formation of derived nominals and derived adjectives are parallel and that both processes are restricted to roughly the same verbal bases.

(10) Some residual problems remain: the lexical entry leaves a gap for cases where a derived nominal is expected but inexistent (cf. *eman* 'the giving/gift', although the compound *harreman* [*har* 'take' + *ema-n* 'give'] 'relationship' exists). This could just be an accidental gap, an unrealized possibility. (17) also excludes a noun like *izan* 'the being'; this noun, however, has an almost idiomatic use. J. Emonds (p.c.) points out that the reason *izan* might escape the generalization is that, in so far as it is grammatical verb, it is not present at D-S. Another factor to be considered is that the relationship between the verb and derived nominal is fairly idiosyncratic in many cases, probably because some nouns have become "lexicalized".

3.2. Non-derivational uses of the perfect morpheme

The preceding section has established that the so-called perfect morpheme in Basque forms both derived adjectives and derived nominals; by the hypothesis adopted throughout this article, their lexical entry predicts these suffixes will already be present at D-S because their insertion is conditioned and/or induced by purely semantic features (on the stem V or on the suffix): STATE in the adjectival use, or +ACTIVITY/MOTION in both uses. The next logical step is to investigate whether these grammatical morphemes are ever semantically "unconstrained" and hence also insertable after S-S, on their way to Phonetic Form. In chapter four, I will argue that is exactly the case for adjectival *i/n/tu* when they function as aspect markers in periphrastic verbs forms; in this case they bear the feature [+completed]. Leaving this late insertion option of adjectival *i/n/tu* aside for a moment, let us turn to the nominalized clauses (NCs henceforth) studied in chapter two. It is immediately obvious that these nominalized clauses have their perfective counterparts, as was pointed out there:

- (20) a. Espero dut [DP Ainhoa Seattle-ra etor-tze-a]
 expect aux -adl arrive-TE-art
 lit: "I expect [Ainhoa's coming to Seattle]"
 I hope that Ainhoa will come to Seattle
- b. Espero dut [DP Ainhoa Seattle-ra etorr-i-a]
 expect aux -adl come-perf-art
 lit: "I expect [Ainhoa's having come to Seattle]"
 I hope that Ainhoa has already arrived in Seattle
- (21) a. Damu dut [DP hori orain esa-te-a]
 regret I-have that now say-TE-art
 I regret [saying that now]
- b. Damu dut [DP hori lehenago ez esa-n-a]
 regret I-have that before no say-perf-art
 I regret [not having said that before]

Not surprisingly, the perfective nominalizers are exactly the morphemes *i/n/tu*. I specify this in (22); a tree diagram for the bracketed NCs is given in (23):

- (22) *i*, *n*, N, [+completed], +V____
tu, N, [+completed], +V____¹¹

(11) The feature [completed] simply designates whether or not the event denoted by the verb is terminated (cf. Zagona 1989). As Zagona suggests, it might as well be the case that what is crucial is that *some aspect* of the event be prior to a given reference point.

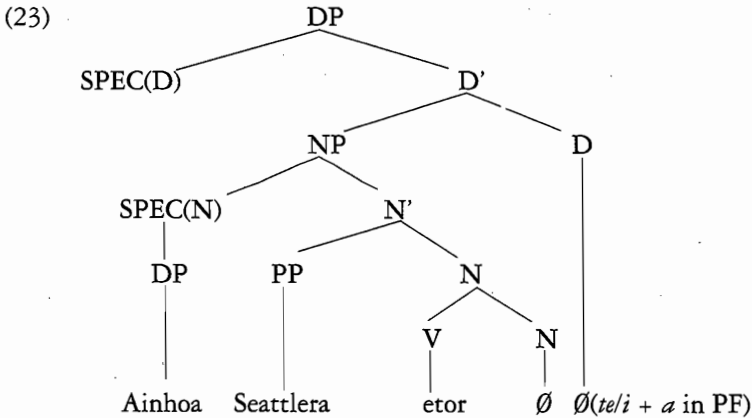

The properties of these perfective nominalized clauses are essentially the same as those of the NCs studied in the previous chapter (nothing new needs to be said), except that the nominalizer *te* studied there is lexically specified as [-completed] whilst *i/n/tu* are specified as [+completed].

We can now factor out the derivational and syntactic uses of nominal *i/n/tu*:

- (24) Lexical entry (Nominal *i, n* and *tu*; merges (19) & (22))
- | | | |
|--------------------------------|---|--|
| <i>i</i> , <i>n</i> , N, +V___ | } | { (+N {V = +NATIVE, +ACTIVITY/MOTION})
N = [+completed] |
| <i>tu</i> , N, +V___ | } | { (+N {V = +ACTIVITY/MOTION})
N = [+completed] |

If the parenthesized option is chosen, the derivational use of the perfect morpheme will result: crucially, the formation of derived nominals will be restricted to a specific subclass of verbs, where additional absorption of the noun phrase complement of the verb is obligatory. Otherwise the lexical entry predicts that NCs of the perfective type are generated.

3.2.1. Perfect nominalized clauses in adjunct positions

3.2.1.1. Verbal adjuncts

The nominalized clauses of the perfect type are in principle able to occur as complements to any contentful postposition, although this option is not often realized probably due to stylistic reasons¹². These NCs, however, are frequent when they bear the grammatical formative *ta* or (*r*)*ik* depending on the dialect¹³; hence-

(12) This is also true of English perfect gerunds:

i. a. After seeing you, Ainhoa is happy again

ii. a. Miles enjoyed playing with Bird

b. After having seen you, Ainhoa is happy again

b. Miles enjoyed having played with Bird

Obviously, the (a) sentences *may* include the interpretation of the (b) sentences, while the reverse is not true.

(13) This (*r*)*ik* is homophonous with the partitive morpheme, but different. See de Rijk (1972b) for the differences between partitive (*r*)*ik* and this "stative RIK" (de Rijk's term).

forth I will refer only to *ta*, but the generalizations extend to both *ta* and (*r*)*ik* morphemes:

- (25) a. *Ardoa eda-n-da* edozein afari animatzen da
 wine drink-perf-TA any party get-lively aux
 (With) the wine drunk, any party is lively
 b. *Hitzaldia amai-tu-ta*, parlamentariak zutik jarri ziren
 speech finish-perf-TA deputies up stand aux
 (With) the speech finished, the deputies stood up
 c. *Kalera irte-n-da*, Ainhua pozik jarri zen
 street-adl leave-perf-TA happy get aux
 Gone out to the street, Ainhua got/turned happy

The English translations show that this structures are indeed similar to the traditional *absolute constructions*; but unlike in English, a nominative subject can always be licensed in Basque:

- (26) a. *Asierrek ardoa eda-n-da* edozein afari animatzen da
 (With) *Asier* having drunk wine, any party is lively
 b. *Lehendakariak hitzaldia amai-tu-ta*, parlamentariak zutik jarri ziren
 (With) *the president* having finished the speech, the deputies stood up
 c. *Gu guztiok kalera irte-n-da*, Ainhua pozik jarri zen
 With *all of us* gone out to the street, Ainhua got/turned happy

I suggest that this is because the internal structure of the italicized constituent is as in (23) above, namely a nominalized clause in the sense of the previous chapter. Recall from the discussion in chapter two that nominative (where “nominative” stands for ergative/ absolutive) subjects in nominalized DP clauses are assigned case by DET under certain conditions:

- (27) The functional category D in DP assigns nominative case iff a verb is L-head of DP at S-S

I assume this is also the source for the nominative subjects in (26). The only element that still has to be accounted for is the grammatical formative *ta*. Obviously, the morpheme *ta* serves the function of licensing the nominalized DP as an adjunct (an adjunct DP cannot stand by itself—it would receive neither θ -role nor case). Since the tenseless structures in (25-26) are always adjuncts, I will assume that *ta* is in fact a morpheme of category P(ostposition) (i.e. a dummy, contentless P), which selects a perfect NC as +V⁺[+completed]. The article remains phonetically unrealized just like in any other singular PP in Basque. Further evidence in favor of the P membership of *ta* is provided in section 3.4.3¹⁴.

(14) This analysis squares well with the fact that *ta* derives historically from another closed class item, namely the conjunction *eta* ‘and’. The alternative would be to analyze these tenseless structures as pure CPs and *ta* as a complementizer; this is problematic since the obvious resemblance with NCs of the perfect type would be missed and, in order to preserve the generalization that the perfect morpheme is either nominal or adjectival, one would have to postulate the existence of an empty auxiliary and an abstract INFL node to assign case.

3.2.1.2 *Nominal adjuncts*

Characterizing these *ta*-headed adjunct structures as PPs whose DP complement is a nominalized clause of the perfect type (the internal structure of which was studied in detail in chapter two) sheds further light on the nature of Basque tenseless relatives (cf. Artiagoitia 1991). Tenseless relatives are formed by attaching the postposition *ko* to any *ta*- (or (*r*)*ik*)-headed "clausal" PP:

- (28) a. [[Ardoa eda-n-da-ko] andrea] gaisotu egin da
 wine drink-perf-TA-KO woman get-sick aux
 The woman [that has] drunk wine has gotten sick
 (lit: "the wine-drunk woman ...")
 b. [[Atxagak idatz-i-ta-ko] nobela berria] itzel gustatzen zait
 name-E write-perf-TA-KO novel new a lot be-pleasing aux
 I like a lot the new novel [that] Atxaga [has] written
 (lit: "the new Atxaga-written novel ...")

The postposition *ko* is ordinarily obligatory on any PP or CP (argument or adjunct) when they occur DP-internally:

- (29) a. Zurrumurrua da Ainhoa gaisorik dagoela
 rumor is sick stays-comp
 The rumor is that Ainhoa is sick
 b. [Ainhoa gaisorik dagoela-KO zurrumurrua] egia da
 sick stays-comp-KO rumor true is
 The rumor that Ainhoa is sick is true
- (30) a. Autobusa Bilbora doa b. Hau [Bilbora-KO autobusa] da
 bus Bilbao-adl goes this Bilbao-adl-KO bus is
 The bus goes to Bilbao This is the bus for/to Bilbao

Naturally, this confirms that *ta* must be either a postposition or a complementizer. In Artiagoitia (1991), it was extensively argued that the bracketed structures in (28) and the like have the behavior of Complex Noun Phrases and that the head noun is modified by a tenseless relative "clause" which contains an empty operator. Hence, the exact representation of (28) should be as in (31), with the empty operator in the spec (D) position¹⁵:

- (31) a. [[[[Op_i e_i ardoa eda-n]DP-da]pp-ko]pp andrea_i] gaisotu egin da
 The woman [that has] drunk wine has gotten sick
 (lit: "the wine-drunk woman...")
 b. [[[[Op_i Atxagak e_i idatz-i]DP-ta]pp-ko]pp nobela berria_i] itzel
 gustatzen zait
 I like the new novel [that] Atxaga [has] written a lot
 (lit. "I like the new Atxaga-written novel... a lot")

(15) The tests for "Complex Noun Phrase-hood" were various in Artiagoitia (1991): pronominalization, impossibility of extraction, pied-piping, etc.

(32) a.

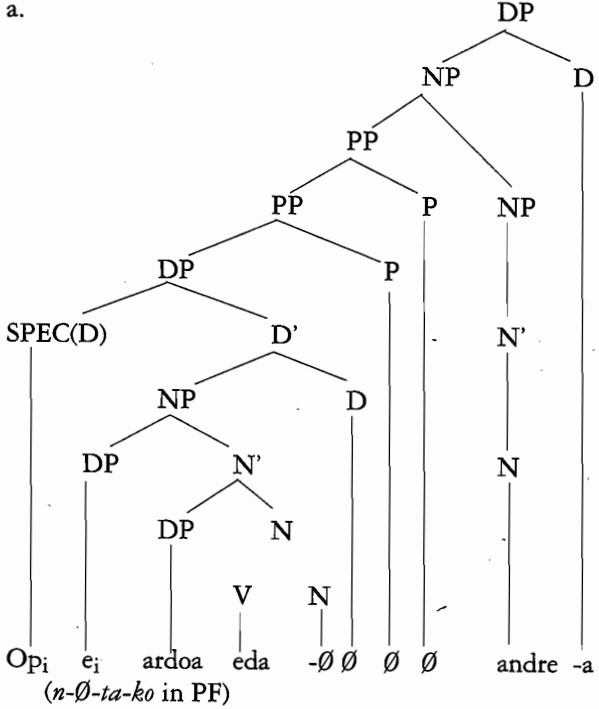

b.

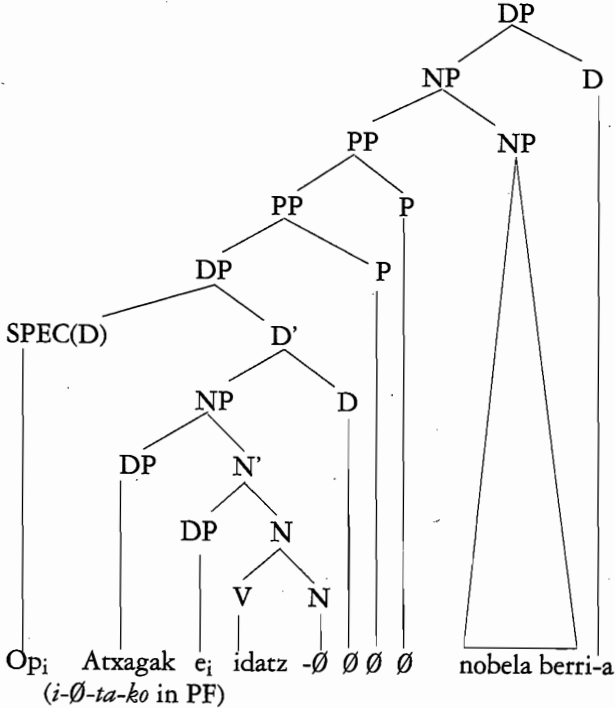

The fact that $\text{spec}(D)$ is an operator position in tenseless relatives formed with perfective NCs is hardly a surprise. We already saw in chapter one that $\text{spec}(I)$ in Basque may be described as an operator position; subjects do not need to raise to that position in order to receive case from INFL (cf. Koopman & Sportiche 1991). Given the parallelism between IP and DP, $\text{spec}(D)$ is expected to be an operator position (DP-subjects do not move to $\text{spec}(D)$), although it is not a possible landing site for [+WH] elements, as seen in chapter two. A similar situation arises in English DP-gerunds, which lack a COMP or $\text{spec}(C)$ position proper in standard analyses like Stowell's (1983). However, to the extent that $\text{spec}(D)$ is empty when no overt subject is present (cf. section 3.2.1, chapter two), an operator may indeed occupy that position, as it is surely the case in parasitic gap constructions:

(33) a. Which linguist_i did you hate t_i [_{PP} after [_{DP} Op_i PRO meeting t_i]?]

b. ...

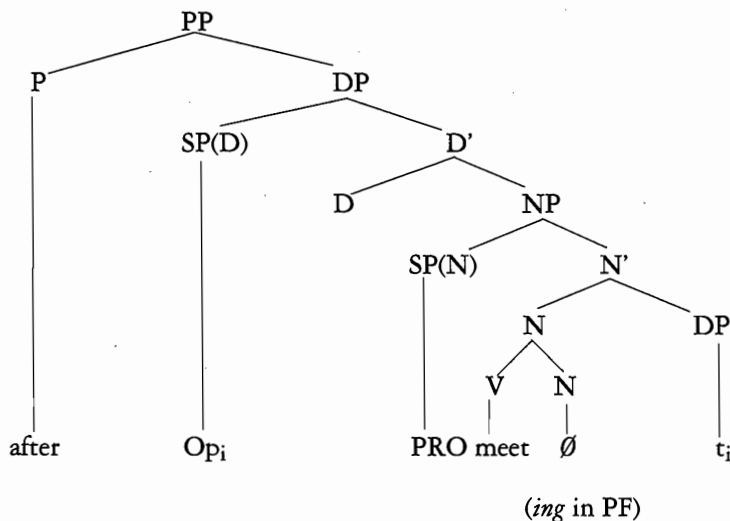

Unlike in Basque, where overt subjects need not raise to $\text{spec}(D)$ and $\text{spec}(I)$, overt subjects in English do raise to the latter positions. This predicts that parasitic gaps will not be licensed in gerunds with overt subjects because the operator position, namely $\text{spec}(D)$, is occupied by the subject that moves from $\text{spec}(N)$ to $\text{spec}(D)$:

(34) *Which linguist did you hate after Mary's meeting ?

Consequently the data support the claim that $\text{spec}(D)$ may be occupied by [-WH] operators in both English and Basque¹⁶.

(16) The prediction is perhaps that English should have relative structures formed with DP-gerunds. It is generally assumed that this is not the case. However, the so-called *reduced relatives* studied in Emonds (1976: 166-172) and taken to be dominated a VP node (Cf. Fabb 1983) and more recently by an AP node (cf. Emonds 1990), might be analyzed in this fashion:

Going back to the contrasts between (28a/31a) and (28b/31b), the preceding analysis of tenseless relatives in Basque also predicts that the gap in the relativized “clausal” DP may correspond to either the subject or the object. This is possible because the subject position of these “clausal” DPs is assigned nominative case by DET under the conditions studied in chapter two (cf. (27) above) without the subject’s moving to the spec(D) position. Recall that the nominalized DP clause is generated when the nominalizer is subject to late lexical insertion, as is predictable from its lexical entry:

$$(24) \quad \begin{array}{l} i],n], N, +V ___ \left\{ \begin{array}{l} (+N \{V = +NATIVE, +ACTIVITY/MOTION\}) \\ N = [+completed] \end{array} \right\} \\ tu], N, +V ___ \left\{ \begin{array}{l} (+N \{V = +ACTIVITY/MOTION\}) \\ N = [+completed] \end{array} \right\} \end{array}$$

Crucially no “argument absorption” is associated with this (non-parenthesized) value of *i/n/tu*.

The proposal made in this section avoids the hypergeneration of maximal phrases in the analysis of tenseless clauses, which was a problem in Artiagoitia (1991), where a full clausal structure (IP, CP) was assumed; and it also sets the basis for a unified analysis of perfect and non-perfect tenseless relatives formed with the nominalizer *te*. This generalization was not captured in Artiagoitia (1991). The situation with the Basque perfect morpheme in nominal adjuncts contrasts with English, where “perfect” morphology is always associated with the category adjective and with phrasal absorption (cf. Emonds 1989) (and the external argument is suppressed (cf. Grimshaw 1990)¹⁷. Therefore, the English counterparts to (28/31) are impossible, unless the subject is expressed by an adjunct by-phrase (cf. Zubizarreta 1987) or a relevant compound is available:

$$(35) \quad \text{en], A, +V} ___ \left\{ \begin{array}{l} \{STATE\} + NP \\ \{+[V \emptyset] ___ \} \end{array} \right\} \quad (\text{Emonds 1989: 31})$$

- (36) a. [The woman *(that has) drunk wine] has gotten sick
 b. I like [The new novel *(that) Atxaga *(has) written]
 c. I like [The new novel written by Atxaga]
 d. * ... [The new Atxaga-written novel]
 cf. e. [The new computer-operated device]
 cf. f. [The new woman/man-controlled system]

To sum up, late insertion of the nominal value of the perfect morpheme gives raise to (perfective) NCs of the type studied in the previous chapter. These NCs are

(i) [Those people travelling to Tokyo] should go to gate 1.

(ii) [Those people [DP Op; [NP t; travelling to Tokyo]]] ..

This suggestion is not without problems because DPs are generally not licensed as DP-internal adjuncts.

(17) As far as I understand his proposal, the suppression of the external argument in Emonds’s framework follows from his assumption that a morpheme (present at D-S) coindexed with the absorbed phrasal complement must receive the interpretation of the complement. Otherwise, any other suffix slot is interpreted as subject by default (i.e. if there is no coindexing or if no morpheme is present).

selected by the dummy postposition *ta* in order to form verbal adjuncts. Tenseless relatives can be construed by attaching the suffix *ko* to a PP headed by the postposition *ta*. This type of nominal adjunct, although similar in meaning to English adjectival passives in attributive position, differs from the latter in that the modified noun may indistinctively bind the subject or the object argument inside the tenseless relative.

3.3. The perfect morpheme in predicative contexts

In this section I will discuss two predicative uses of the perfect morpheme, when it occurs as complement to the verb *egon* 'be, stay' (cf. Sp. *estar*), and I will show that these predicative phrases are both dominated by a PP node. In the case of "stative" PPs (cf. (37)), I claim that these are selected as P heads in the base; crucially, the postposition *ta* subcategorizes for the perfect morpheme (the nominal value). In the case of the *experiential perfect* construction (cf. (38)), I propose that the PPs are in turn selected as +V[^][+completed]; I will try to argue that the insertion of *ta* in these cases is triggered by the Minimal Structure Principle discussed in chapter one *pace* the θ -Criterion. The relevant data are given in (37)-(38):

- (37) a. Dena *esa-n-da* dagoenan istorioak berrasmutzen ditugu
 all say-perf-TA stays-comp stories reinvent aux
 When everything is said, we reinvent stories
- b. Independentziaren sua [itzal-i-ta] dagoela dirudi
 independence-gen fire extinguish-perf-TA stays-comp seems
 It seems that the fire of independence is extinguished
- c. Ainhoa [ikaratuta] dago
 frighten-perf-TA stays
 Ainhoa is frightened
- (38) a. Asier [Ameriketean *ego-n-da*] dago
 America-loc stay-perf-TA stays
 Asier has been in America (once at least)
 (lit: "Asier stays stayed in America")
- b. Gu [filme hori *ikus-i-ta*] gaude
 we movie that see-perf-TA stay
 We have seen that movie
 (lit: "We stay/remain seen that movie")
- c. Ainhoa [Gorbeiarda *igo-n-da*] dago
 Gorbea-adl climb-perf-TA stays
 Ainhoa has climbed to Mt. Gorbea (once at least)
 (lit: "Ainhoa stays climbed to Mt. Gorbea")

3.3.1. *Stative PPs*

The sentences with deverbal predicates in (37) have the property that their subjects generally correspond to the internal argument of the verb to which the perfect morpheme is affixed; the derived predicate may not have the full range of complements that the verb usually has:

- (39) a. Dena [(*) umeei] *esa-n-da* dago
 all kids-dat say-perf-TA stays
 Everything is/remains said (**) to the kids
 b. Lana [(*) irakasleari] *ema-n-da* dago
 work teacher-dat give-perf-TA stays
 The papeer stays/is given to the teacher

(39) proves that the verb is not the selectionally dominant head, like in English adjectival passives. The derived predicates in (37) resemble the English adjectival passives in yet another important aspect: they are complements to verbs like *irudi* 'seem', and they may also function as secondary predicates:

- (40) a. Su honek [*itzal-i-ta*] dirudi
 fire this-E extinguish-perf-TA seems
 This fire seems extinguished
 b. Ainhoa [*ikara-tu-ta*] ikusten dut
 frighten-perf-TA see aux
 I see Ainhoa frightened

In principle it might seem natural to derive the existence of these deverbal predicates from their "adjective-hood", which was summarized in the lexical entry given in (12):

- (12) Basque:
i], *n*], A, +V ____ + N, STATE {V = +NATIVE, +ACTIVITY/+MOTION}
tu], A, +V ____ + N, STATE, {V = +ACTIVITY/+MOTION}

Yet in (37) and (40) we find that the presence of the postposition *ta* (or (*r*)*ik* in other dialects) is obligatory. Despite the momentarily unexplained presence of *ta*, one might try to argue for the adjectival character of *esanda*, *itzalita*, *ikaratuta* in (37) and (40) on the following bases:

a) APs (with the feature +A) are selected on the same environments; i.e. as complements to *egon*, to verbs like *irudi* 'seem' and as secondary predicates:

- (41) a. Ainhoa *urduri* dago
 Ainhoa is nervous (state)
 b. Ainhoak *urduri* dirudi
 Ainhoa seems nervous
 c. Ainhoa *urduri* ikusten dut
 I see Ainhoa nervous

This evidence is nonetheless inconclusive because nominal, postpositional, and clausal (modal) predicates are possible in the same environments:

- (42) a. Ainhoa *irakasle / problemekin / zer egin ez dakiela* dago
 teacher problems-com what do no knows-comp is
 Ainhoa is ("stays") [as a] teacher / with problems / not knowing
 what to do (lit: "that she doesn't know what to do")
- b1. Ainhoa *datarren urtean irakasle* ikusiko dugu
 next year-loc teacher see aux
 We'll see Ainhoa [as a] teacher next year
- b2. Ainhoa *problemekin / zer egin ez dakiela* ikusten dut
 I see Ainhoa with problems / not knowing what to do
 (lit: "that she doesn't know what to do")

b) These *ta*-headed predicates seem to admit several specifier elements such as *oso* 'very' and *nabikoa* 'rather', etc.:

- (43) a. Ainhoa *oso ikara-tu-ta / oso urduri* dago
 Ainhoa is very frightened / very nervous
- b. Ainhoak *oso ikara-tu-ta / oso urduri* dirudi
 Ainhoa seems very frightened / very nervous
- c. Ainhoa *oso ikara-tu-ta / oso urduri* ikusten dut
 I see Ainhoa very frightened / very nervous

This again is not sufficient to posit that *ta*-headed predicates are APs; these specifier elements also modify some locational PPs and hence should be regarded as both spec(A) and spec(P):

- (44) Osasuna *sailkapenean oso / nabikoa beherantz*a joan da
 name league-loc very quite down-dir go aux
 Osasuna has gone very/quite downwards in the league standings

Furthermore, some spec(A) modifiers that appear post-adjectivally are incompatible with these predicates; *samar* 'rather', the diminutive *txo*, and the comparative:

- (45) a. Ainhoa **ikara-tu-ta samar / urduri samar* dago
 Ainhoa is rather frightened / rather nervous
- b. Ainhoa **ikara-tu-ta-txo / urduritxo* dago
 Ainhoa is a little frightened / a little nervous
- c. Ainhoa Asier baino **neka-tu-ta-ago / urduriago* dago
 than more
 Ainhoa is more frightened / more nervous than Asier

Finally, the fact that these predicates cannot be DP-internal modifiers also refutes the idea that they might be considered adjectival:

(46) Amets *apur-tu-ak* ez ditu etorkizunak berreraikiko
 dream break-perf-art no aux future-erg rebuild
 The future will not rebuild broken dreams

(47) * Amets *apur-tu-ta-ak* ez ditu etorkizunak berreraikiko
 break-perf-TA-art
 The future will not rebuild broken dreams

Therefore, I conclude that these predicates are not dominated by an AP node. Instead, I will assume that they are dominated by a PP node headed by *ta* and selected as a P head. I adopt de Rijk's suggestion that *ta* and (*r*)*ik* are associated with the feature STATE (they are "stative"; cf. note (13)) and propose that they have the subcategorization frame P, +N___, STATE (where N must be *i*, *n* or *tu*). The feature STATE will force D-S insertion of *ta*; at that level, on the basis of (24) we equally predict that the only possible realizations of the nominal value of the perfect morpheme will be circumscribed to unaccusative and transitive verbs.

(48) a. *ta*] (*rik*], P, $\left\{ \begin{array}{l} +V^{\wedge}[+completed] \\ +N___, STATE^{18} \end{array} \right\}$ b.

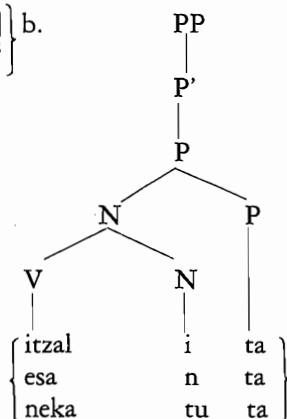

An interesting issue arises when we ask why these deverbal predicates are not selected as A(dj)ectives), which is indeed a possibility by virtue of the lexical entry (12); if selected as mere Adjectives, we do not expect the presence of the postposition *ta*. I have no explanation for this, except to suggest that perhaps the selection of a P head is preferred to selection of a deverbal adjective because the Adjectival value of the perfect has been "imported" by Basque from Indo-European. I will simply point out that in some dialects (notably in Gipuzkoan Basque), the adjectival option is in fact realized; the deverbal predicates studied in this section do *not* surface with the postposition *tal*/*(r)ik*, but rather with number agreement (=the article), which is absent in this position in standard Basque:

(18) Perhaps the feature [+completed] is also present on the perfect morpheme when the latter is subject to D-S insertion. If so, (48) can be further generalized:

i. *ta*], (*rik*], P, $\left\{ \begin{array}{l} +V^{\wedge}[+completed] \\ +N___, STATE, \{N = [+completed]\} \end{array} \right\}$

- (49) a. (%) Ainhoak *ikara-tua* dirudi vs Ainhoak *ikara-tu-ta* dirudi
Ainhoa seems frightened
- b. (%) Ainhoa Asier baino *ikara-tu-agoa* dago vs ... **ikara-tu-ta-ago* ...¹⁹
Ainhoa is more frightened than Asier
- c. (%) Semaforoa *gorri-a* dago vs ... *gorri-Ø* dago²⁰
Traffic-light red-art red-Ø
The traffic light is red

Interestingly enough, this adjectival variant of deverbal predicates seems an innovation (hence a change) with respect to Old Basque and the rest of the dialects. One final remark needs to be made with respect to (24), repeated here for convenience:

- $$(24) \begin{array}{l} i], n], N, +V \text{---} \left\{ \begin{array}{l} (+N \{V = +NATIVE, +ACTIVITY/MOTION\}) \\ N = [+completed] \end{array} \right\} \\ tu], N, +V \text{---} \left\{ \begin{array}{l} (+N \{V = +ACTIVITY/MOTION\}) \\ N = [+completed] \end{array} \right\} \end{array}$$

Although referential nouns derived from the perfect morpheme are in principle possible with the three perfect endings, this option is *seemingly* more common with morphemes *i* and *n*. The solution proposed in this section to account for the *ta*-headed deverbal predicates assumes implicitly that this is accidental. Nonetheless, we can maintain (24) as basically correct, and posit that the relative scarcity of (referential) *tu*-derived nouns is actually a reflection of its being the only productive morpheme to form derived nominals (cf. Lieber 1992: 4-9 on frequency *vs* productivity). The apparently larger number of nouns derived from *i* and *n* may thus be regarded as mere "lexicalizations", historically but non-synchronically related to the corresponding verbs. Support for this view comes from the fact that many verbs may productively form *tu*-derived nouns which are not listed in corpora and dictionaries:

- (50) a. [Zapaltzaileek eta *zapat-du-ek*] elkar gorrotatzen dute
cf. b. [The oppressors and the *oppress-ee-s*] hate each other
cf. c. [Los opresores y los *oprim-ido-s*] se odian (Spanish)

Without adopting a definitive position here, I note that the formation of nouns from the perfect morphemes is predicted to be possible by virtue of (24) and, when so, it is circumscribed to a semantic class of verbs.

(19) In the dialects where the nominal option is chosen and the postposition *ta* appears on the surface, the comparative morpheme (=spec(A)) is possible for many speakers *without the postposition* itself (and without number agreement):

- i. Ainhoa Asier baino *neka-tu-ago* dago (cf. (49b))

This means that the "adjectival" perfect morpheme can be selected when the comparative is used. This could be taken to support the claim that the comparative (Degree) is the head of the predicate (Degree Phrase). Be it as it may, (i) is consistent with the fact that the perfect morpheme in Basque is both nominal and adjectival, and that when the former option is chosen to form predicates, a grammatical postposition is required.

(20) There are a couple of exceptions to the non-agreement status of APs as complements to *egon* 'be, stay': e.g. the adjective *on* when applied to food/drinks:

- i. Ardoa(-k) *ondo* / *ona(-k)* dago (daude) The wine(s) is (are) good (pl).

3.3.2. *The VP type of participial PP*

The participial predication of the type illustrated in (38) (sometimes referred to as an *antipassive construction* cf. Rebuschi 1983), is, as far as I know, exclusive to Western Basque and has the interpretation of an *experiential perfect* (cf. Comrie 1976: 58). The bracketed predicates in (38) have three salient properties: a) they behave like simple "VP"s (cf. 51) in that verbs appear with their corresponding complements (any verb is possible) and in that the subject of the sentence is always the external argument as in a regular sentence:

- (51) a. Asier [*(Ameriketan) ego-n-da] dago
 Asier has been *(in America) (once at least)
 b. *Umea [ipuina konda-tu-ta] dago
 kid tale tell-perf-TA stays
 The kid has been told the story (lit: "the kid stays told the story")
 [o.k. meaning "the kid has told the story"]

b) these predicates are only possible as complements to the verb *egon*, which acts as a "semi-auxiliary" verb (cf. 52):

- (52) Asier [Ameriketan ego-n-da] dago
 stay-perf-TA stays
 Asier has been in America (once at least)

- (53) * Asier [Ameriketan ego-n-da] dabil / da
 walks is

c) the morpheme *ta* (or (*r*)*ik*) appears obligatorily on the perfect morpheme:

- (54) Asier [Ameriketan ego-n-da / *ego-n-Ø] dago
 Asier has been in America

Properties (a) and (b) follow from the assumption that the verb *egon* can select a verbal head together with the feature [+completed], which later triggers the insertion of the perfect morpheme, not present until PF:

- (55) *egon*, V, +V^Δ[+completed]

Property (c) is all the more intriguing. In section 3.2.1, we have characterized the morpheme *ta* as a member of category P, although the alternative possibility that it is of category C was mentioned in note 14. This has been further supported by the discussion in 3.3.1 above. Consider (38b) and (56) below, where a tensed CP with an impersonal sentence (the external argument is not realized syntactically) in the predicate position yields an ungrammatical result:

- (38b) Gu [filme hori *ikus-i-ta*] gaude
 we movie that see-perf-TA stay
 We have seen that movie (lit: "We stay/remain seen that movie")

- (56) *Gü [filmea ikusi de-la] gaude
 we movie see-perf aux-comp stay
 *We “stay”/are [that the movie has been seen] (... one has seen the movie)

(56) would be the perfect counterpart to (38b) if the bracketed constituent in (38b) were indeed a CP. The fact that (56) is ungrammatical lends additional support to the claim that *ta* is indeed a postposition (and not a complementizer). Given that *ta* is now undoubtedly a postposition, the question still remains as to why a postposition should be projected in (38) in the first place. The reason becomes clear once we bear in mind that the Basque perfect morpheme is nominal; thus, if *egon* selects as proposed in (55), nothing in principle could prevent the generation of a nominalized DP clause with its own internal subject. But in that case the subject of *egon* will not receive any θ -role: neither from the subcategorized verb since all θ -assignment will be internal to the DP clause, nor from *egon* since crucially *egon* does not assign any θ -role. This ungrammatical result is illustrated in (57a) and (57b):

- (57) a. * Asier [Ainhoa Gorbeia i go-n-da] dago
 Asier “stays”/has [Ainhoa climbed to Mt. Gorbea]
 (cf. Asier is going home *vs* *Asier is [Ainhoa’s going home])
 b.

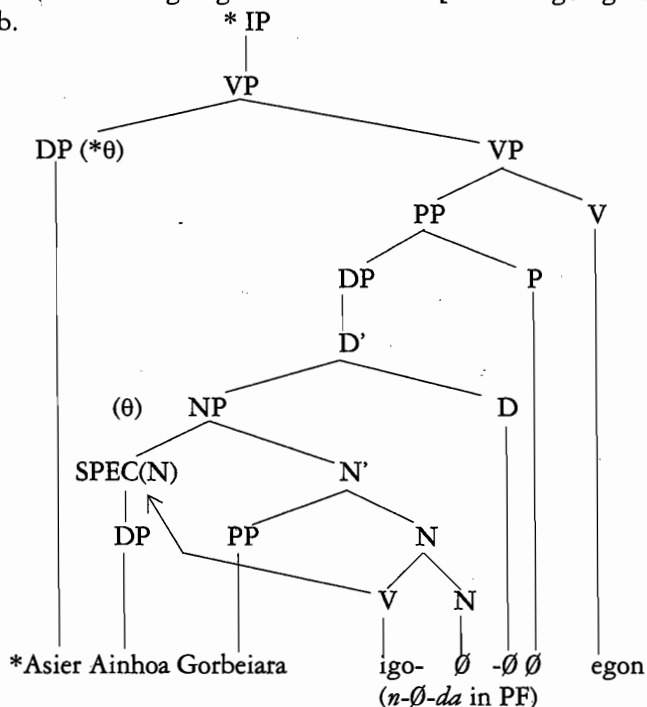

We now understand why *ta* must be inserted; the postposition *ta* is licensed by the Minimal Structure Principle *pace* the θ -Criterion to prevent the nominalizing

suffix (*n* in this case) from projecting into a normal phrase, and hence from leaving the main subject without a θ -role, as in (57b):

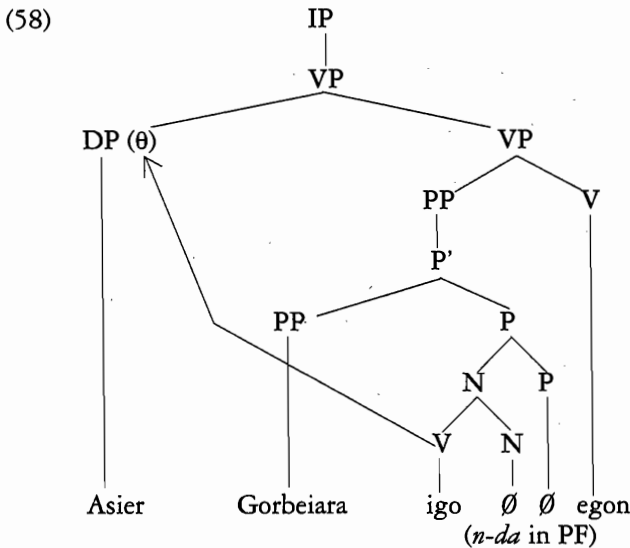

This is in line with Chomsky's (1991) notion of *Economy of Representation*. In (58) the perfect morpheme has the nominal value, bears the feature [+completed], as argued before, and is subject to late lexical insertion. Considering the perfect morpheme merely adjectival like in English would make the insertion of the postposition a total puzzle. I assume the postposition *ta* is inserted under the empty P node in PF because it may also subcategorize for a noun morpheme specified as [+completed]:

- (59) *ta*, P, +N[^][+completed]____
 [where late inserted nominal *tu, i, n* are specified as [+completed]]

We thus arrive at the following lexical entry for *ta*:

- (60) *ta*, P, a. +V[^][+completed]
 b. +N____, STATE (N= *i, n, tu*)
 c. +N[^][+completed]____

In other words, *ta* may take perfective nominalized clauses as complements (option *a*, cf. 3.1) or may be an affix on nominal elements (options *b* and *c*). In the *b* case, the semantic feature STATE guarantees that P is already present at D-S and simply forms derived words of category P; the fact that the noun derivation based on the perfect morpheme is itself restricted to transitive and unaccusative verbs at D-S by (24) explains all the facts about stative PPs discussed in section 3.3.1. Option *c*, on the other hand, asserts that *ta* is bound affix insertable after S-S on any noun specified as [+completed]; this accounts for (58) and the examples discussed in this section. Given the similarity between the non-phrasal subcategorizations, it is tempting to further generalize (60). If the suggestion in note 18 is on the right track

(viz. if the feature [+completed] is present on the perfect morpheme even when inserted at D-S), we can maximally generalize the lexical entry of *ta*:

$$(60)' \quad ta \left\{ \begin{array}{l} P, \quad +V^+ [+completed] \\ \quad \quad +N __ (STATE) \{N = [+completed]\} \end{array} \right\}$$

After discussing these two kind of PP predicates both licensed by the nominal properties of the perfect morpheme, I now turn to the so-called "passive" construction in Basque.

3.4. On the so-called passive

So far I have established that the so-called perfect morpheme in Basque has in fact dual categorial status (N and A), and further that it can be inserted at both D-S and after S-S (on its way to PF). Its occurrences are in fact predicted from the respective lexical entries, summarized here as (61) and (62):

$$(61) \quad \begin{array}{l} \text{a. } [i], [n], A, +V __ \left\{ \begin{array}{l} (+N, STATE \{V = +NATIVE, \dots \\ \dots +ACTIVITY / MOTION \}) \\ A = [+completed] \end{array} \right\} \\ \text{b. } [tu], A, +V __ \left\{ \begin{array}{l} (+N, STATE \{V = +ACTIVITY / MOTION\})^{21} \\ A = [+completed] \end{array} \right\} \end{array}$$

$$(62) \quad \begin{array}{l} \text{a. } [n], [i], N, +V __ \left\{ \begin{array}{l} (+ N \{V = +NATIVE, \dots \\ \dots +ACTIVITY / MOTION \}) \\ N = [+completed] \end{array} \right\} \\ \text{b. } [tu], N, +V __ \left\{ \begin{array}{l} (+ N \{V = +ACTIVITY / MOTION \}) \\ N = [+completed] \end{array} \right\} \end{array}$$

Moreover, the occurrence of the postposition *ta* with the perfect morpheme was claimed to arise as a result of the nominal value of the perfect, which is selected by the postposition. In this section, I will focus on the so-called "passive construction" of Basque and show that it is in fact a tenseless relative structure of the kind pointed out in section 3.2; this is in line with Eguzkitza's (1981) and Ortiz de Urbina & Uribe-etxebarria's (1991) proposals.

3.4.1. *More on tenseless relatives*

In section 3.2.1.2, I have analyzed tenseless participial relatives as PPs which contain nominalized DP "clauses" of the perfect type headed by an empty operator in the *spec(D)* position; this is a welcome move since it solves an oversight from Artiagoitia (1991), where tenseless non-perfective relatives were analyzed as having a nominal head, as opposed to tenseless perfective relatives, which had no nominal head. Recall from section 3.2.1.2, that the formation of tenseless relatives involves

(21) As was noted at the beginning of section 3.2, the late insertion option of an *adjectival* perfect morpheme will be discussed in the next chapter. This option has been reflected in the lexical entry (61b) for ease of exposition.

ta-headed PPs which surface with the dummy postposition *ko*; this postposition affixes to any DP-internal PP or CP:

- (63) a. [[[OP_i e_i ardoa eda-n-∅ DP]-da pp]-ko pp] andrea_i gaisotu egin da (=31a)
 The woman [that has] drunk wine has gotten sick
 b. [[[OP_i Atxagak e_i idatz-i-∅ DP]-ta pp]-ko pp] nobela_i berria_i itzel
 gustatzen zait (=31b)
 I like a lot the new novel [that] Atxaga [has] written

Depending on the dialect, (*r*)*ik* is used instead *ta* in sentences like (63). There is even more dialectal variation: in some subdialects of Biscayan Basque, and apparently in northern dialects too (cf. Lafitte 1962), tenseless relatives are possible without either *ta* or (*r*)*ik* mediating between the DP and *ko*²²:

- (64) a. [Ardoa eda-n-∅-eko andrea] gaisotu egin da
 wine drink-perf-∅-KO woman get-sick aux
 The woman [that has] drunk wine has gotten sick
 b. [Atxagak idatz-i-∅-ko nobela berria] itzel gustatzen zait
 write-perf-∅-KO novel new a lot be-pleasing aux
 I like a lot the new novel [that] Atxaga [has] written

The last variation on tenseless relatives is found in dialects where no overt postposition intervenes between the relative DP and the head noun:

- (65) a. [Ardoa eda-n-∅ andrea] gaisotu egin da
 b. [Atxagak idatz-i-∅ nobela berria] itzel gustatzen zait

For congruence reasons, I will assume that an empty postposition is present even in (65) to license the "relative" DP. Having established a few further facts about tenseless relatives in Basque, I now return to the question of the "passive" construction.

3.4.2. Explaining the non-existence of the passive

That there is no "passive" or "passive transformation" proper in Basque has long been recognized by generative syntacticians (cf. Wilbur 1979). This is for example de Rijk's (1978) position, who credits Bouda for the suggestion that the apparent passive is derived from a relative clause: "there is no Passive rule in Basque... there is a resultative "Passive",... derived from a bi-clausal source by means of Relative Clause Reduction, as Bouda (1973: 27) and, no doubt, many others too, have recognized" (de Rijk 1978: 84-85). Eguzkitza's (1981) article is a more elaborate attempt to formalize this notion; Eguzkitza extensively argues that Bollenbacher's (1977) claim that there exists a passive transformation in Basque is empirically

(22) This is probably because *ko* may also attach to attributive DPs:

i. Bihotz on-eko andrea
 heart good-KO
 A woman of good heart

untenable. He proposes that what might look like a passive in Basque is in fact derived from a tensed relative clause reduction, as suggested by de Rijk/Bouda. Some examples of the apparent passive construction are given below:

- (66) a. *Liburu hau (Leizarragak) aspaldian idatz-i-a da*
 book this Leizarraga-E long ago write-perf-art is
 This book is the (one) written by Leizarraga long ago
 (lit: "this book the long ago Leizarraga-written (one)")
- b. *Liburu hauek (Leizarragak) aspaldian idatz-i-ak dira*
 book these -E write-perf-art are
 These books are the (ones) written by Leizarraga long ago
 (lit: "these books are the long ago Leizarraga-written (ones)")²³
- (67) a. *Liburua (Kepak) Edurneri ema-n-a da*
 Kepa-E Edurne-dat give-perf-art is
 The book is the (one) given by Kepa to Edurne
- b. *Liburu hauek (Kepak) Edurneri ema-n-ak dira*
 book these -E give-perf-art are
 These books are the (ones) given by Kepa to Edurne

What is taken to be the Basque passive usually consists of a subject noun phrase, the corresponding form of the copula *IZAN* 'be', and a constituent headed by the perfect form of the verb and the article, which agrees with subject. This last constituent may or may not contain a noun phrase bearing ergative case. The basic arguments disputing the "passive" status of (66)-(67) are fairly conclusive and I summarize them below, cf. also Eguzkitza (1981), Ortiz de Urbina & Uribe-etxebarria (1991). The argument (b) and, partially, (d) are my own:

a) In Basque the inflected verb displays agreement with datives; hence, in (67) the verb should in principle agree with the dative/indirect object *Edurneri*, but this is impossible:

- (68) **Liburu hau/hauek Kepak Edurneri ema-n-a zai/zaizkio*
 book this/these -E is-to-her/ are-to-her
 This book is (dat-agr)/ these books are (dat-agr) the (one/s) given by
 Kepa to Edurne

b) Sentences (66a/b) are in the present tense but contain a time PP/adverbial modifier, *aspaldian* 'long ago', which must modify a past event. If (66a/b) were true passive structures, there should be a similar active counterpart in the present tense; but this counterpart does not exist, because *aspaldian* is incompatible with the present tense of *idatzi* 'to write' (cf. 64a below). Rather, the only "active" sentence that comes close to (66) is a sentence in the past tense:

- (69) a. **Leizarragak aspaldian liburu hauek idazten ditu*
 -E long ago book these write aux

(23) Although from now on I gloss the ergative noun phrase of the Basque examples as a by-phrase (no tenseless "perfect" relative clause exists in English), the ergative is best translated actively, as will become clearer.

- Leizarraga writes these books long ago
 b. *Leizarragak aspaldian liburu hauek idatzi zituen*
 Leizarraga wrote these books long ago

This strongly suggests that there are two separate sentences involved in (66): the main clause with the copula in the present tense, and some embedded sentence-like structure the verb of which *aspaldian* modifies.

c) Even though Basque is a free word-order (scrambling) language, the elements inside the italicized structure in (66) can never be moved out, "scrambled", which contrasts with the free worder in a sentence that would be considered "active":

- (70) a. *Leizarragak liburu hauek [aspaldian idatz-i-ak] dira
 Leizarraga-E book these long ago write-perf- art are
 b. *Liburu hauek [idatziak] dira aspaldian Leizarragak
 c. *Aspaldian liburu hauek [Leizarragak idatziak] dira
 d. *Liburu hauek [Leizarragak idatziak] dira aspaldian

- (71) a. Leizarragak liburu hauek aspaldian idatzi zituen
 Leizarraga-erg book these long ago write aux
 Leizarraga wrote these books long ago
 b. Liburu hauek idatzi zituen aspaldian Leizarragak
 c. Aspaldian liburu hauek Leizarragak idatzi zituen
 d. Liburu hauek Leizarragak idatzi zituen aspaldian

d) In that respect, the italicized elements of (66) behave like a complex noun phrase (CNP):

- (72) a. Liburu hauek [Leizarragak aspaldian idatzi zituenak] dira
 book these -E long ago write aux-com- art aux
 These books are the (ones) that Leizarraga wrote long ago
 b. *Leizarragak liburu hauek [*e* aspaldian idatzi dituenak] dira
 c. *Nork dira liburu hauek [aspaldian idatzi dituenak]?
 *Who are these books the (ones) that *e* wrote long ago ?

This claim is confirmed by other properties of CNPs in Basque such as pied-piping and the impossibility of a short answer to a wh-phrase in a pied-piped structure:

- (73) Q: [(Aspaldian) nork idatz-i-ak] dira liburu hauek ?
 long ago who write-perf-art are book these
 These books are [the (ones) written by whom] ?
 A1: *Leizarragak
 A2: Leizarragak idatz-i-ak dira...
 The (ones) written by Leizarraga

- (74) Q: [(Aspaldian) nork idatzi zituenak] dira liburu hauek ?
 long ago who write aux-comp-art are book these
 These books are [the (ones) that who wrote long ago]?
 A1: *Leizarragak

A2: Leizarragak idatzi dituenak...

The (ones) that Leizarraga wrote...

In conclusion, the four tests above demonstrate that the italicized/bracketed structures are a separate constituent, a syntactic island, instead of a VP²⁴; moreover, this constituent appears to be a complex noun phrase, which contains an empty head noun and a tenseless relative. Once the "passive" structure has been identified with a complex noun phrase containing a headless relative structure (in fact the postpositionless type discussed in 4.1.), the apparent resemblance of the Basque structures to the Indo-European passive is obscured; for instance, nothing prevents the Basque CNP from having an overt head:

- (75) a. *Liburu hauek* [Op_i *Leizarragak aspaldian e idatz-i liburuak*]_i
 book these -erg long ago write-perf book-art
dira (cf. 66b)
 are
 These books are the *books* written by Leizarraga long ago
 (lit: "these books are the long ago Leizarraga- written books")
- b. *Liburu hauek* [Op_i *Kepak Edurneri e_i eman-n liburuak*]_i *dira*
 book these give-perf book-art are (cf. 65b)
 These books are the books given by Kepa to Edurne
 (lit: "these books are the Kepa-given books to Edurne")

Similarly, and for the reasons explained in section 2.1.2 above, the noun modified by the relative clause may be the subject of the embedded structure:

- (76) a. *Leizarraga* [*liburu hauek aspaldian idatz-i autorea*] *da*
 author
 Leizarraga is the one (author) [that has] written these books long ago
- b. *Kepa* [*liburu hauek Edurneri eman (lagun)-a*] *da*
 friend
 Kepa is the one (friend) [that has] given these books to Edurne

Naturally, even though the postpositionless type of tenseless relatives is the only one mentioned in discussions about Basque "passives", other types of tenseless relatives may also be used for this kind of predication:

- (77) a. *Liburu hauek* [*Leizarragak aspaldian idatz-i-ta-ko-ak*] *dira*
 These books are the ones [that] Leizarraga [has] written long ago
- b. *Liburu hauek* [*Leizarragak aspaldian idatz-i-ta-ko liburuak*] *dira*
 These books are the books [that] Leizarraga [has] written long ago
- c. *Leizarraga* [*aspaldian liburu hauek idatz-i-ta-ko-a*] *da*
 Leizarraga is the one [that has] written these books long ago

(24) There are other problems for a "passive" approach, such as considering ergative DPs as adjuncts (in a parallel fashion to English *by*-phrases); this point is made in Ortiz de Urbina & Uribe-ecxebarria (1991). Eguzkitza (1981) also notes that the optionality of the ergative DP under the "passive" approach would conflict with the productive "detransitivization" phenomenon in Basque.

- d. Leizarraga [aspaldian liburu hauek idatzi-ta-ko *idazlea*] da
 Leizarraga is the writer [that has] written these books long ago

Again all these sentences lack a corresponding "active", as was pointed out in (69a), because *aspaldian* cannot modify the verb *idatzi* in the present tense.

It now becomes clear that what was wrongly termed "passive" in Basque is just an example of a sentence construed with the copula, a subject noun phrase, and a headless noun phrase which contains a tenseless relative. The reason why this remained partly unnoticed is because it was the postpositionless kind of headless relative clause (itself limited to northern dialects) that dominated the debate over "passive sentences" in Basque, since the latter is superficially the closest one to Indo-European passives. The preceding discussion has illustrated the fact that the Basque "passive" as such does not exist; it is rather a CNP (with a zero noun) together with the copula which serves as predicate. A similar proposal has been independently made in Ortiz de Urbina & Uribe-etxebarria, although some non-trivial differences exist between their analysis and mine^{25 26}.

(25) Most notably, that they don't relate the so-called "passive construction" to the whole array of tenseless relative structures. In fact their analysis resembles that of a headless noun phrase containing a tenseless relative clause, but neither term is ever used. Less importantly, they assume a CP status for the tenseless relative clause as in Artiagoitia (1991), a position which I argued against in section 3.2.1.2. O&U also include some examples with the verb *ukan* 'have', used as a "semicopulative" verb [O&U's terminology]:

- | | |
|---|---|
| i. Nik liburu hau idazleak dedika-tu-a dut | ii. Nik lagunak aljeriarrak ditut |
| I-erg book this writer-erg dedicate-perf-art have | I-erg friends-art Algerian-art have |
| This book of mine is dedicated by the author | Friends of mine/my friends are Algerian |
| (lit: "I have this book the (one) dedicated by the writer") | (lit: "I have friends Algerian") |

My analysis remains unaffected if we reject the assumption that *ukan* assigns a θ -role to the DPs *liburu hau* and *lagunak*. This is shown by the fact that the restrictions on the "objects" in (i-ii) are the same to the restrictions on subjects of copulative sentences (both are incompatible with the partitive case). Sentence (iii) and (iv) illustrate the use of semicopulative *ukan* 'have'; the noun phrase cannot be in the partitive case in a negative sentence:

- | | |
|--|--|
| iii. Nik lagunak aljeriarrak ditut (=ii) | iv. *Ez dut lagunik aljeriarra |
| Friends of mine are Algerian | no have friend-part Algerian-art |
| | No friend of mine is Algerian (lit: "I have no friend Algerian") |

In (v) and (vi) the regular copula *izan* 'be' is used, and the subject noun phrase cannot be in the partitive case either, as in (iv):

- | | |
|------------------------------------|--------------------------------------|
| v. (Nire) lagunak aljeriarrak dira | vi. *(Nire) lagunik ez da aljeriarra |
| my friends-art Algerian-art are | -part no is Algerian-art |
| My friends are Algerian | No friend (of mine) is Algerian |

This restriction does not hold when the verb *ukan* is used as a lexical verb meaning 'have'; in that case, the object of *ukan* may bear the partitive case:

- | |
|---|
| vii. Nik ez dut [aljeriar lagunik] |
| I-erg no have Algerian friend-part I have no (Algerian) friend(s) |

Therefore we can conclude that *liburu hau* in (i) is not a bona fide object of *ukan* and that the sentence must be analyzed in a similar fashion to the apparent "passive" structures, except that the verb *ukan* 'to have' functions as a copula, with its subject being interpreted as the possessor of the referential noun phrase in object position.

(26) Another crucial difference is that O&U identify all instances of participial predication with DPs containing open sentences; the analysis pursued in this chapter, on the other hand, suggested that some participial predicates are PPs (or APs in some dialects cf. (49)), whilst others manifest themselves as headless DPs containing a tenseless relative. Let us examine the following sentences:

- | |
|---|
| i. (%) Jonek biharko paper hau [sina-tu-a] ekarriko du |
| Jon-erg tomorrow-for paper this sign-perf-art bring aux |
| Jon will bring this paper signed for tomorrow (O&U's 22a) |
| ii. Jonek paper hau [gurasoek sina-tu-a] ekarriko du |
| parents-erg sign-perf-art bring (O&U's 22b) |
| Jon will bring this paper [which] (his) parents [have] signed |
| (lit: Jon will bring this paper parents-signed) |

The issue, however, is not that Basque does not have a true passive, but rather *why it cannot have a passive* if it has a perfect morpheme, similar to the corresponding Indo-European passive and past participle morpheme in several respects. This, in turn, presupposes that we have a deep understanding of what the lexical properties of the past participle *en* and the passive morphemes are (they are identical in many Western European languages). In work in progress, Emonds (1989) proposes that the "perfect" use of the passive morpheme in periphrastic verb forms may have been a result of the absorbed NP's becoming optional. This captures the generalization that in Indo-European languages the perfect morpheme is always the same as the passive, which he identifies with the category Adjective:

The only superficial difference between (i) and (ii) is the presence of the subject of the verb *sinatu* 'to sign' in (ii). Under O&U's account, both bracketed structures would be assigned the same structure, namely that of a headless relative clause, predicated of *paper hau*. Under the proposals formulated here, however, *sinatua* in (i) is just a case of a deverbal AP used as secondary predicate; this is supported by the fact that other dialects use a deverbal PP with the postposition *ta* ((*r*)ik), as expected from my analysis (cf. section 3.3.1):

- iii. Jonek biharko paper hau [sina-tu-ta] ekarriko du
 Jon-erg tomorrow-for paper this sign-perf-TA bring aux
 Jon will bring this paper signed

Furthermore, it is possible to have a wh-phrase that "inquires" about this secondary predicate:

- iv. a: % Nola ekarriko du Jonek paper hau ? Sina-tu-a ? b: Nola ekarriko du Jonek paper hau ? Sina-tu-ta ?
 how bring aux Jon-erg paper this sign-perf-art sign-perf-TA
 How will Jon bring this paper ? Signed ?

If the structure of (i) and (ii) were the same, in the latter sentence it should be equally possible to have a deverbal PP predicate with the postposition *ta*; but this is not the case:

- v. *? Jonek paper hau [gurasoek sina-tu-ta] ekarriko du
 Jon-erg paper this parents-erg sign-perf-TA bring aux
 Jon will bring this paper parents signed

What is more, no wh-phrase that refers to the participial structure in brackets is allowed:

- vi. a: *? Nola ekarriko du Jonek paper hau ? Gurasoek sina-tu-a ?
 How will Jon bring this paper ? The one [that] his parents (have) signed ?
 b: *? Nola ekarriko du Jonek paper hau ? Gurasoek sina-tu-ta ?
 How will Jon bring the paper ? Parents-signed ?

The only wh-phrase that may replace the bracketed structure in (ii) is *zer* 'what', but in this case *paper hau* is also part of the replaced constituent:

- vii. Speaker A: Zer ekarriko du Jonek ? Speaker B: paper hau gurasoek sina-tu-a
 What will Jon bring ? This paper [that] parents [have] signed

This shows that [*paper hau gurasoek sina-tu-a*] is a constituent, the DP object of *ekarriko* in (ii). I suggest that this constituent is a complex noun phrase and that [*gurasoek sinatua*] is simply an extraposed tenseless relative; (ii) is in fact derived from (viii.a) below, via a postpositionless kind of tenseless relative:

- viii. a. Jonek [[gurasoek sina-tu] paper hau] ekarriko du
 Jon-erg parents-erg sign-perf paper this bring aux
 b. Jonek [[t]i [paper hau]] [gurasoek sinatua]i ekarriko du
 Jon will bring this paper [that] parents [have] signed

This is the phenomenon that de Rijk (1972a: 168-171) terms Pseudo-extraposition, very common in tensed relative clauses in Basque. The article is added to extraposed relative and agrees in number with the antecedent:

- ix. Behin bazen [[zazpi seme-alaba zitueN] errege bat]
 once was seven son-daughter had-comp king one
 Once upon a time, there was a king who had seven sons and daughters
 x. Behin bazen [[t]i errege bat] [zazpi seme-alaba zitueN-a];
 -art

Hence, in (ii) the article on *sinatua* is just a reflection of the number agreement (with *paper hau*) of the extraposed tenseless relative.

Otherwise, my analysis of (ii) doesn't differ in crucial respects from O&U's; the fundamental difference lies in the treatment of predicates like those in (i), which I claim contain no clausal structure but are simply APs (restricted to some dialects) or PPs (the more general option).

$$(78) \quad en], A, +V_ \quad \left\{ \begin{array}{l} \{STATE\}, + NP == + (NP) \\ \{+[v \emptyset]_ \} \end{array} \right.$$

Regardless of whether this is historically true or not for Romance and/or Germanic, a comparison between (78) and (61- 62) (repeated below) shows that in Basque absorption of the NP complement by the perfect morpheme, in both the adjectival and nominal use, is only possible under "early" or D-S insertion; since no absorption feature is ever associated with the morpheme when inserted after S-S structure, it follows that the adjectival perfect morpheme, when and if subject to late lexical insertion, will only appear in periphrastic constructions (cf. next chapter). If nominal, it will display the properties of a nominalized tenseless clause, as explained in (20) above:

$$(61) \quad \begin{array}{l} \text{a. } i], n], A, +V_ \left\{ \begin{array}{l} (+N, STATE \{V = +NATIVE, .. \\ .. +ACTIVITY /MOTION \}) \\ A = [+completed] \end{array} \right\} \\ \text{b. } tu], A, +V_ \left\{ \begin{array}{l} (+N, STATE \{V = +ACTIVITY /MOTION\}) \\ A = [+completed] \end{array} \right\} \end{array}$$

$$(62) \quad \begin{array}{l} \text{a. } n], i], N, +V_ \left\{ \begin{array}{l} (+N \{V = +NATIVE, .. \\ .. +ACTIVITY /MOTION \}) \\ N = [+completed] \end{array} \right\} \\ \text{b. } tu], N, +V_ \left\{ \begin{array}{l} (+N \{V = +ACTIVITY /MOTION \}) \\ N = [+completed] \end{array} \right\} \end{array}$$

In sum, the lack of a true passive in Basque can be minimally reduced to the lexical properties of the grammatical formatives *i/tu/n*, which unlike their Indo-European counterparts, lack the necessary absorption feature associated with the passive morpheme when the latter is inserted after S-S. Given the parallelism between the nominal and the adjectival values of the Basque perfect morpheme, we can factor out what (61) and (62) have in common and propose the following unified lexical entries:

$$(79) \quad \begin{array}{l} \text{a. } i], [+N], +V_ \left\{ \begin{array}{l} (+ N, [+N]: \{V = +NATIVE, ..\}) \\ (A: STATE) \\ [+N] = [+completed] \end{array} \right\} \\ \text{b. } tu], [+N], +V_ \left\{ \begin{array}{l} (+ N, [+N]: \{V = +ACTIVITY ..\}) \\ (A: STATE) [+N] = \\ [+completed] \end{array} \right\} \end{array}$$

[where + N = obligatorily empty at D-S; cf. note 9]

I take [+N] to be an "archicategory" that includes nouns and adjectives, as in Chomsky (1970) and Emonds (1990). If the bracketed option is chosen, the affixes are inserted at D-S with the corresponding semantic restrictions on the verbal bases (the adjectival use is additionally associated with the semantic feature STATE); in either case (A or N), the affix absorbs the first noun phrase complement of the verb. Otherwise, the affixes are not inserted until after S-S on their way to PF, and are invariably associated with the feature [+completed].

Addendum to chapter three

Rebuschi (1983, 1989) has argued that the stative PP predicates studied in section 3.3.1 (and alternatively realized as APs in other dialects (cf. 49)) may show up with the external argument marked ergative, in what he assumes is a passive structure:

- (1) a. (*) Azak [aitak landa-tu-ta] daude
 Cabagges father-E plant-perf-TA stay
 The cabagges stay/are planted by the father
 b. (*) Eskutitzak [Pellok idatz-i-ta] daude
 letters -E write-perf-TA stay
 The letters are written by Pello

Although some speakers might accept sentence (1) as grammatical, others (including myself) find it a mere copy of the corresponding Romance sentence, which contains the verb *estar* and an adjectival passive:

- (2) a. Las berzas están plantadas por el padre
 b. Las cartas están escritas por Pello

Rebuschi derives (1) and (2) by movement of *azak* 'cabagges' and *eskutitzak* from inside the bracketed constituent and considers *aitak* and *Pellok* as adjuncts:

- (1)' Azak_i [aitak e_i landa-tu-ta] daude
 (2)' Eskutitzak_i [Pellok e_i idatz-i-ta] daude

This analysis is problematic on two counts: first, assuming that the moved constituents originate in the *e* positions and are part of a clause-like constituent at D-S, there is no reason whatsoever for these noun phrases to move if they are sisters to *landatuta* and *idatzita* since adjunct "clausal" PPs headed by *ta* are possible as we saw in 3.2.1.1 and nothing prevents the verb from assigning case to its object. Rebuschi assumes that the constituent is a VP, which suggests he has little to say about the categorial status of *ta* in either the verbal adjunct ("clausal") use or the one at issue here. Second, Rebuschi's account makes an incorrect prediction: if (1) is a passive structure, then *all transitive verbs are in principle possible targets* for this construction, which is incorrect:

- (3) a. Filme hau [(*guk) ikus-i-ta dago]
 movie this we-E see-perf-TA stays
 This movie is heard (*by us)
 b. Lehioa [(*umeeek) apur-tu-ta] zegoen
 window kids-E break-perf-TA stayed
 The window was/remained broken (*by the kids)
 c. Ainhua [(*mamuek) ikara-tu-ta] dago
 (storm-E) frighten-perf-TA stays
 Ainhua is/remains scared (*by the ghosts)

In fact, a close look at the examples shows that the sentences given by Rebuschi all correspond to Romance adjectival passives that allow an adjunct *por-phrase* (similar to English *by-phrase*). Where the Basque examples à la Rebuschi are uncontroversially ungrammatical as in (3), so are the Romance adjectival passives with a *por-phrase*:

- (4) a. Esta pelcula ya está vista (*por nosotros)
 b. La ventana estaba rota (*por los niños)
 c. Ainhoa est asustada (*por los fantasmas)
 [(4c) is ok with the reason interpretation of *por*, but not with agentive interpretation].

As a matter of fact, the same tends to be true of the corresponding English adjectival passives. This proves that speakers who accept (1) are merely translating Romance sentences and systematically substituting *por-phrases* for ergative DPs, where the former is licensed (cf. Grimshaw 1990). To the extent that this phenomenon is spreading, we are confronted with an ongoing change in the grammar of Basque: the source of the ergative marker need not always be the spec(V) position (or put it differently, the nominative case of unergative and transitive verbs); it is also becoming some kind of postposition similar to the prepositions *por* (Spanish) and *by* (English). To the extent that (1) is rejected by many speakers, we have good reason to consider it an ungrammatical sentence in Basque. In any event, the preceding discussion leaves no doubt that sentences like (1) are to be equated with adjectival passives and not with true passives. Actually, Rebuschi himself notes that the verb *egon*, used mainly in the South Basque Country, is pretty much the equivalent of Spanish *estar*.

4. The lexical nature of Basque participles

This chapter argues that the hypothesis that *aspect* is a functional category (in the sense of Fukui & Speas 1986) which heads its own maximal projection in Basque is untenable on a number of counts. My argument will focus on the following idea: even though Basque superficially provides evidence for a syntactic head position related to *aspect*, uncontroversial considerations nevertheless show that these heads are actually lexical heads of category N, A or P. The solution presented is appealing because two of the heads that supposedly represent the category *aspect* in Basque are precisely the morpheme *te* and the perfect morphemes *i/n/tu* shown on independent grounds in chapters two and three to be marked for aspect features when subject to late lexical insertion. I will argue that the use of such morphemes as “aspect markers” in periphrastic verbal constructions is not surprising, but rather predictable from their lexical entries. The discussion is organized in the following manner: section 4.1 reviews the basics of Basque verbal forms and argues that the auxiliary verbs *izan* ‘be’ and *ukan* ‘have’, as opposed to the modal auxiliaries **edin* and **ezan*, do not originate under the INFL node but are actually main verbs. Section 4.2 shows that analyzing the complements to the auxiliary verbs *izan* ‘be’ and *ukan* ‘have’ in Basque as Aspect Phrases (or simple VPs) makes incorrect predictions with respect to coordination and cannot account for the similar distribution of non-present participles and a subclass of locative PPs. In section 4.3, it is claimed that the shortcomings of the Aspect Phrase analysis can only be adequately solved if these maximal projections are rather projections of lexical heads (A and N-P in particular); this approach in turn makes crucial use of the theory of selection and subcategorization discussed earlier in this article and of Lieber’s (1992) Percolation Conventions.

4.1. Basque auxiliary verbs are main verbs

4.1.1. Basque verbal forms revisited

As pointed out in chapter one, of the two types of verbal forms in Basque, viz synthetic and periphrastic, the latter is by and large the most common, whereas the former option is restricted to a handful of verbs. Traditional grammarians describe synthetic forms in the present and the past tenses as having “punctual aspect” (i.e. they are incompatible with a habitual interpretation):

- (1) a. Ainhoak egunkaria dakar
 -E paper brings
 Ainhoa is bringing the newspaper (*brings)
- b. Ainhoak egunkaria zekarren
 brought
 Ainhoa was bringing the newspaper (*brought/ *used to bring)

Periphrastic forms, on the other hand, generally consist of a) a verb stem and some affixes conveying aspectual information, and b) an auxiliary verb *izan* ‘to be’ or *ukan* ‘to have’, which bears agreement (subject and object) markers as well as tense

morphology. Unlike in English, a given auxiliary may combine with any among three participles:

- (2) a. *Ainhoak egunkaria ekarr-i* du
 Ainhoa-E paper bring-perf has
 Ainhoa has brought the newspaper
- b. *Ainhoak egunkaria ekarr-i* zuen
 had
 Ainhoa brought the newspaper

- (3) a. *Ainhoak egunkaria ekar-tze-n* du
 Ainhoa-E paper bring-TE-loc has
 Ainhoa brings the newspaper (*is bringing)
- b. *Ainhoak egunkaria ekar-tze-n* zuen
 had
 Ainhoa used to bring the newspaper (*was bringing)

- (4) a. *Ainhoak egunkaria ekarr-i-ko* du
 Ainhoa-E paper bring-perf-KO has
 Ainhoa will bring the newspaper
- b. *Ainhoak egunkaria ekarr-i-ko* zuen
 bring-perf-KO had
 Ainhoa would bring the newspaper (= was to bring the newspaper)

I refer to the uninflected verb forms in italics as the perfect, the non-perfect and the future participles respectively. The perfect participle in (2) is formed by the verbal stem and the perfect morpheme studied in the previous chapter; the non-perfect participle in (3) is formed by the verbal stem, the morpheme *te* (cf. chapter two) and the locative postposition *n*; the future participle in (4) is formed by attaching the perfect morpheme and the postposition *ko* to the verbal stem. A second type of periphrastic verb conjugation is formed with the bare verbal stem and the auxiliary verbs **edin* 'be able to' (unaccusatives) and **ezan* 'be able to' (transitives and unergatives). These verbs are cited with an asterisk because they are reconstructed (unattested) infinitival forms and lack lexical meaning. These conjugated verb-auxiliary pairs translate as modal verbs and are also the base of the subjunctive forms in subordinate clauses and imperatives¹:

- (5) a. *Ainhoak egunkaria ekar-∅* dezake c. *Ekar-∅ ezazu* egunkaria!
 can bring can paper
 Ainhoa can/may bring the newspaper Bring the newspaper!
- b. *Ainhoak egunkaria ekar-∅* deza-n...
 -comp
 (so) that Ainhoa (may) bring the newspaper...

(1) Verbs that have synthetic present and past tenses can also use the present as imperative and, in an almost literary use, as a subjunctive.

4.1.2. *Previous analyses*

Goenaga's (1980) amalgamation analysis for synthetic verbs has been recast in Ortiz de Urbina (1989), accurately in my view, as V-to-I movement, as in Chomsky (1986b):

- (6) a. Ainhoak egunkaria dakar
 paper brings
 Ainhua is bringing the newspaper
- b.
-
- ```

graph TD
 IP --> DP1[DP]
 IP --> I_prime[I']
 DP1 --> Ainhoak[Ainhoak]
 I_prime --> VP[VP]
 I_prime --> I[I]
 VP --> DP2[DP]
 VP --> V[V]
 DP2 --> egunkaria_t[egunkaria ti]
 V --> t_i[ti]
 I --> AGR_TNS["[AGR, TNS]"]
 AGR_TNS --> ekar_i["ekari -> (dakar at PF)"]

```
- Ainhua is bringing the newspaper

Although no argument for V-raising is given in Ortiz de Urbina (1989), support for a V-raising analysis of Basque synthetic verbs comes from the order of the verb with respect to modal particles like *omen* 'apparently' and *bide* 'surely', assumed by most authors (e.g. Eguzkitza 1986) to be generated under INFL (cf. 1.3.1). Recall from chapter one that non-finite verbs in Basque require that their complements be immediately to their left (disregarding the cases of object focalization). The fact that inflected verbs are separated from their complements by the modal particles constitutes evidence that V-raising rather than I-lowering takes place in Basque:

- (7) Ainhoak liburua (omen) dakar (\*omen)  
       -E book apparently brings  
       Ainhua is apparently bringing a book

Under the proposal made in chapter one (namely that the unmarked word-order in Basque results from V movement to INFL and subsequent movement of INFL into COMP), (7) has the following structure:

- (8) [CP [IP [I t<sub>i</sub>] [vp Ainhoak liburua [v t<sub>i</sub>] ] ] [C [I (omen) dakar]<sub>i</sub> ]]

Assuming that the modal particles originate under the INFL node, initial lowering of INFL to V would produce a structure of the form [V V-INFL] (or more precisely [V V-[I Particle/INFL]]); this would predict that the modal particle could follow the verb, which is not the case. If V moves to INFL, as proposed here, then the new head will be of the form [I INFL-V] or rather [I [I Particle/INFL]-V], and the right order is predicted<sup>2</sup>.

(2) The argument still holds, of course, if one assumes that INFL is final in Basque, as Eguzkitza (1986) and Ortiz de Urbina (1989) do.



In the case of verb + auxiliary periphrastic forms, Eguzkitza (1986) and Ortiz de Urbina (1989) assume that no movement takes place and that the features of INFL (AGR and TENSE) are spelled out in the auxiliary (whether the latter is *izan/ukan* or *\*edin/\*ezan*):

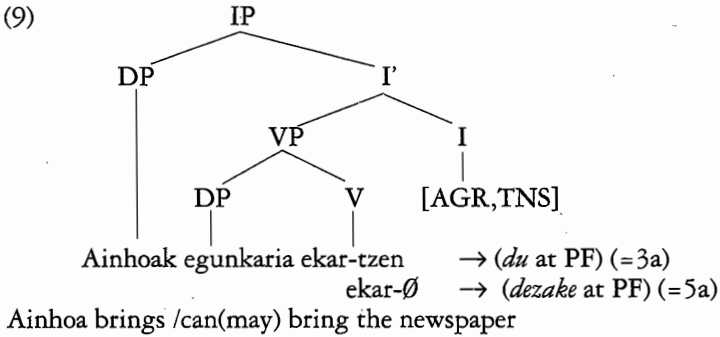

Although her analysis agrees for most part with Eguzkitza's and Ortiz de Urbina's, Laka (1990) further proposes that an Aspect Phrase mediates between VP and IP. In the case of synthetic (i.e. "non-perfective and non-habitual") verb forms, the verb moves from V to INFL through Aspect; otherwise, aspect markers are overtly realized and the verb only moves to Aspect:

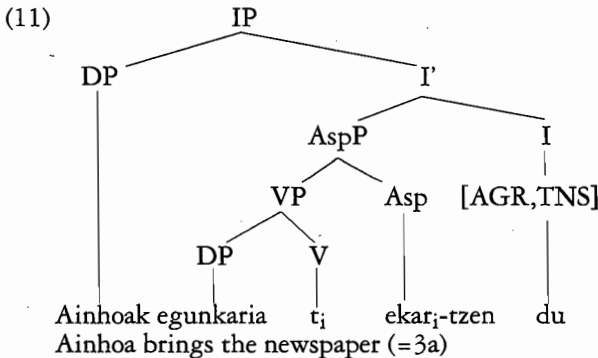
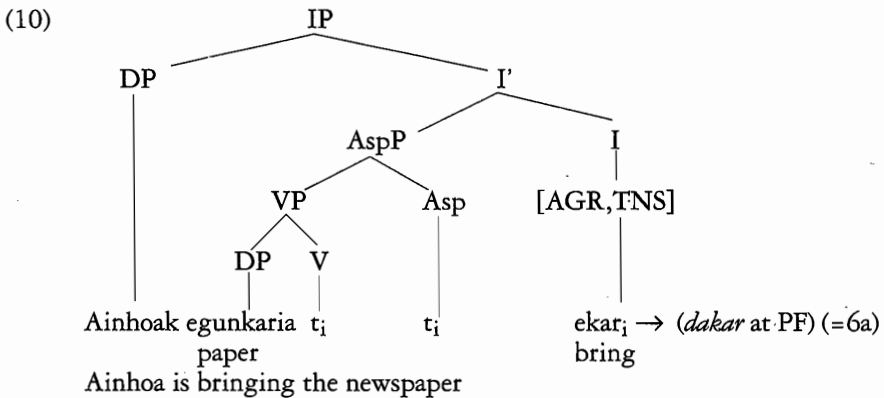

In the case of modal auxiliaries (i.e. *\*edin/\*ezan*), Laka must assume that the verb moves to Aspect, realized as a zero morpheme in this case (cf. her footnote 9). Laka's proposal attempts to account in a natural fashion for the presence of the aspect markers, which do not receive special attention under Ortiz de Urbina's and Eguzkitza's analyses. Laka assumes that affixation of the verb to Asp is derived by morphological subcategorization of the Asp head independent of the selection of VP by AspP. By adscribing the morphemes (i.e. *in/tu*, *ten* and *in/tu + ko*) to the category Aspect, their syntactic presence is recognized. In what follows, I will show that *izan* 'be' and *ukan* 'have', unlike *\*edin* and *\*ezan* 'be able to' (which are mere spellouts of INFL), are syntactically main verbs and hence head their own VP. The nature of the maximal projection complement to the auxiliary verbs *izan* and *ukan* will be the subject matter of sections 4.2 and 4.3.

#### 4.1.3. *izan* and *ukan* as main verbs

The main verb status of auxiliaries *have* and *be* in English has long been recognized (cf. Ross 1969, Emonds 1976, Zagana 1988a, Pollock 1989a). This is so despite the fact that *have* and *be* pattern with modals in many cases; this paradigm is standardly assumed to reflect the fact that these two verbs are the only ones that raise to INFL in English (cf. Emonds 1976, Pollock 1989a). In the case of Basque, there are two kinds of arguments which can be adduced to argue that *izan* and *ukan*, but not *\*edin/\*ezan*, are main verbs: a) arguments based on the distribution and form of auxiliaries in contexts other than inflected auxiliary forms; and b) arguments that rely on the government properties of both *izan/ukan* 'be/have' in contrast to *\*edin/\*ezan* 'be able to'. I begin with the first kind.

##### 4.1.3.1. *Distribution*

One simple observation is that both *ukan* and *izan* are also main verbs, meaning 'have' and 'be' respectively. If synthetic verbs (including the main verbs *ukan* and *izan*) which undergo V-to-I movement head their own VP, X-Bar theory dictates that the same should be the case for the auxiliary verbs *ukan* and *izan*, especially if the actual forms of the verbs are exactly the same in both the main verb and the auxiliary verb uses:

- (12) a. *Ainhoak kristalezko bihotza du*  
           -E glass-inst-ko heart has  
           Ainhua has a heart made of glass  
       b. *Ainhoak euritakoa ahaz-tu du*  
           -E umbrella forget-perf has  
           Ainhua has forgotten (her) umbrella



- (16) a. \* *edi-te-a* / \* *eza-te-a*  
 \* canning / being able to
- b. \* Ainhoak kristalezko bihotza *dezake*  
 -erg glass-inst-ko heart ezan/be able to  
 Ainhoa can (have??) a heart of glass
- c. \* Ainhoa xamantgarria *daiteke*  
 charming edin/be able to  
 Ainhoa can (be??) charming
- d. \* Ainhoa Bilbora joan *edin* daiteke  
 Bilbao-adl go be-able-to edin  
 Ainhoa can be able to go to Bilbao

These arguments show that \**edin*/\**ezan* are in fact similar to English modals in being spellouts of INFLectional features, i.e. they never appear in non-finite positions.

#### 4.1.3.2. *The syntax of verbs in Basque*

Consider the following examples involving operator-verb structures; under the heading *operator* I include wh-phrases, foci, and the negative and the emphatic markers (cf. chapter one):

- |                                                                                                                                                                                                    |                                                                                                                                                                                                 |
|----------------------------------------------------------------------------------------------------------------------------------------------------------------------------------------------------|-------------------------------------------------------------------------------------------------------------------------------------------------------------------------------------------------|
| <p>(17) <i>Ba dator</i> Ainhoa etxera<br/>         aff arrives home-adl<br/>         Ainhoa is coming home</p> <p>(19) <i>ETXERA dator</i> Ainhoa<br/>         It's home that Ainhoa is coming</p> | <p>(18) <i>Ez dator</i> Ainhoa etxera<br/>         neg<br/>         Ainhoa is not coming home</p> <p>(20) <i>Nora dator</i> Ainhoa?<br/>         where<br/>         Where is Ainhoa coming?</p> |
|----------------------------------------------------------------------------------------------------------------------------------------------------------------------------------------------------|-------------------------------------------------------------------------------------------------------------------------------------------------------------------------------------------------|

In chapter one, when discussing the basics of Basque word order, I proposed that the *left dislocation* effects (cf. de Rijk 1969, Ortiz de Urbina 1989b) in sentences with wh-phrases, focused phrases and the negative and affirmative markers (*ez* and *ba*) arise because INFL in Basque must assign the functional feature [+operator] to an element in spec(I) or inside INFL. I also argued that the unmarked SOV order obtains when no feature assignment takes place and INFL moves to COMP (a case of substitution) to avoid a violation of the *Principle of Functional Feature Assignment*, which requires an element of category F specified for some functional feature to obligatorily assign it if it is under FP (chapter one, section 1.1.1). The trees of sentences (17)-(20) under the INFL-initial analysis are given below:

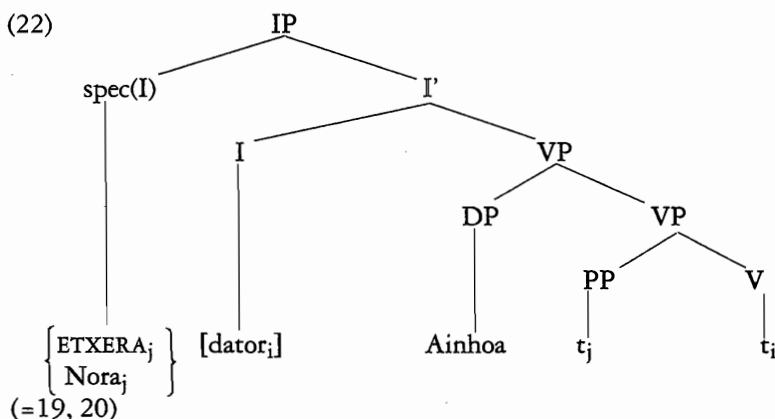
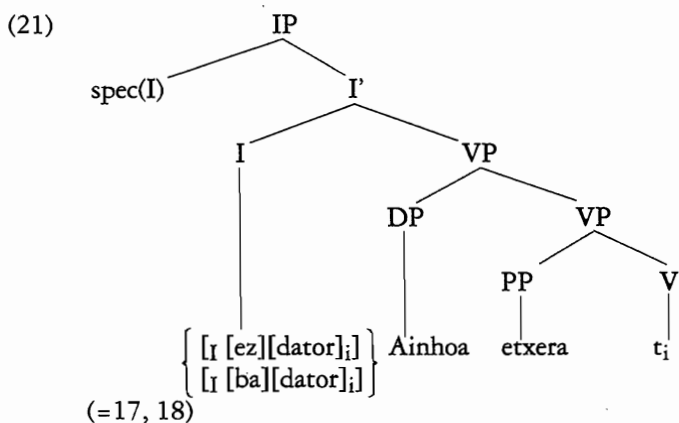

It was also claimed in chapter one that when the requirement that INFL assign its functional feature is satisfied internally to the INFL node (i.e. it is assigned either to the negative marker or the affirmative marker), the subject is free to occupy the spec(I) position without being interpreted as focus:

(23) [IP Ainhua<sub>i</sub> [I *ba / ez dator*]<sub>j</sub>] t<sub>i</sub> etxera t<sub>j</sub> ]

What is crucially at stake here is the fact that *izan/ukan* behave like synthetic verbs and differently from the modal auxiliaries with respect to operator constructions. With the negative and affirmative morphemes, the auxiliary verbs *ukan/izan* move to INFL just like any other synthetic verb (cf. 17, 18), leaving the main verb (= the participle) behind<sup>5</sup>:

(5) In these cases too (i.e. when the assignment of the functional feature takes place INFL-internally with the verbs *izan* and *ukan*), the subject may move to spec(I) without being interpreted as the focus of the sentence (cf. chapter one, section 1.3.3):

i. Ainhua [I *ba da*]<sub>j</sub> etxera etorriko t<sub>i</sub> (cf. (24))

ii. Ainhua [I *ez da*]<sub>j</sub> etxera etorriko t<sub>i</sub> (cf. (25))

The word-order in (i) and (ii) is actually more common than that in (24) and (25).

- (24) [IP [I *Ez da*<sub>i</sub>] Ainhoa etxera etorr-i-ko t<sub>i</sub> ]  
           no is                   home-adl come-perf-KO  
 Ainhoa will not come home
- (25) [IP [I *Ba da*<sub>i</sub>] Ainhoa etxera etorr-i-ko t<sub>i</sub> ]  
           aff  
 Yes, Ainhoa WILL come home

Although wh-phrases and foci generally precede the entire periphrastic verbal sequence (main verb + aspect markers + *ukan/izan*), the auxiliary verbs *ukan* or *izan* may be the only verbal material adjacent to these operators (the “main” uninflected verb remains in its original position). This (stylistically marked) behavior is exactly what we expect if *ukan/izan* are main verbs:

- (26) a. [IP ETXERA [I *da*<sub>i</sub>] Ainhoa etorr-i-ko t<sub>i</sub> ]  
           home-adl is                   come-perf-KO  
 b. [IP ETXERA [I etorr-i-ko; *da*<sub>i</sub>] Ainhoa t<sub>j</sub> t<sub>j</sub> ]  
           Ainhoa will come HOME
- (27) a. [IP Nora [I *da*<sub>i</sub>] Ainhoa etorr-i-ko t<sub>i</sub> ]?  
           where  
 b. [IP Nora [I etorriko; *da*<sub>i</sub>] Ainhoa t<sub>j</sub> t<sub>j</sub> ]?  
           Where will Ainhoa come ?

The possibility of the participle's preceding the auxiliary verb in INFL in (26b) and (27b) arises because the main uninflected verb may adjoin to the auxiliary as discussed earlier in chapter one (section 1.3.3)<sup>6</sup>.

The modal auxiliaries, on the other hand, *must* be preceded by the main verb if a wh-phrase of a focused XP occupies the spec(I) position:

- (28) a. \*? [IP ETXERA [I *daiteke*] Ainhoa etor ]  
           home-adl can                   come  
 b. [IP ETXERA [I etor; *daiteke*] Ainhoa t<sub>j</sub> ]  
           Ainhoa can come HOME
- (29) a. \*? [IP Nora [I *daiteke*] Ainhoa etor ]?  
           where

(6) This adjunction is ruled out when the *neg/aff* morphemes are present:

- i. \* Etorr-i-ko [I *ez/ba da*] Ainhoa etxera  
           come-perf-KO neg/aff is                   home-adl  
           Ainhoa WILL (not) come home

This prohibition against adjunction of the participle to INFL in the presence of NEG/AFF may be derived as follows: if NEG originates left-adjoined to INFL and INFL is the only head in Basque that precedes its sister, one can assume that NEG is in a sense the head within the INFL complex. Adjunction of the uninflected main verb will create the following structure inside INFL:

- ii. [<sub>(i)</sub> Neg V-asp<sub>i</sub> [Neg ez [I aux<sub>j</sub> ]]] .... t<sub>i</sub> t<sub>j</sub>

Given Chomsky's (1986b) proposal that all verbs must agree and be coindexed in a series of V\* aspectual verbs, the agreement process between the two verbs is blocked (as a subcase of minimality) by Neg, a non-agreeing head; the same is true of affirmative *ba*. If indices *i* and *j* cannot agree (i.e. *i* does not equal *j*), then the participle cannot antecedent govern its original trace and the chain [V-asp<sub>i</sub>... t<sub>i</sub>] is ill-formed. In the absence of either *ez* or *ba*, the head-adjunction process is free to apply as in chapter one (cf. 1.3.3); the participle can agree with the auxiliary without any intervening head, *i* equals *j*, and Relativized Minimality is respected.

- b. [<sub>IP</sub> Nora [<sub>I</sub> etor<sub>i</sub> daiteke] Ainhoa t<sub>i</sub> ]?  
Where can Ainhoa come ?

Under the INFL initial analysis proposed in chapter one, the ungrammaticality of (28a)-(29a) reduces to the lack of any governing capacity of the modal auxiliaries. No movement is involved, but a bare INFL is unable to govern into (and hence assign nominative case to) the subject position inside the VP (and possibly unable to assign or discharge its functional feature). Another alternative, suggested to me by J. Emonds (p.c.), is to assume that modal auxiliaries are inserted after S-S; the INFL node is empty at D-S and S-S and thus cannot govern the subject position, as just mentioned. (28b) and (29b), on the other hand, are grammatical because the adjunction of the participle to INFL makes the latter a governing head<sup>7</sup>. With regard to the negative/affirmative morphemes, the modal auxiliaries are for most part incompatible with them, although there is some variation in the judgments:

- (30) ?? (%) [<sub>IP</sub> [<sub>I</sub> Ez daiteke] Ainhoa etxera etor ]  
neg edin home-adv come  
Ainhoa cannot come home

- (31) \*? [<sub>IP</sub> [<sub>I</sub> Ba daiteke] Ainhoa etxera etor ]  
aff  
Ainhoa can come home

(30) and (31) are accounted for in exactly the same manner as (28a) and (29a): Basque modals are unable to govern and assign case to the subject. (30) is acceptable in some dialects on the assumption that *ez* makes a modal INFL a governing head<sup>8</sup>.

(7) (28b) and (29b) are reminiscent of Koopman's (1984) analysis of Vata and Gbadi in that she claims that some instances of V-movement are triggered by the Case Filter: "V-movement must apply in order to allow nominative case to be assigned" (1984: 138). The difference is, of course, that V-movement in these languages takes place when no element occupies the INFL node, whereas V-movement in Basque takes place even when the modal auxiliaries occupy INFL. This difference is accounted for if modal INFL in Basque is somehow defective for government.

(8) (30) is good for speakers of the North Basque Country. In the dialects where (30) is grammatical, *ez* has a wider distribution than in the rest, and can negate a sentence with the auxiliary verbs *izan/ukan* and the modal participle *abal*:

- i. Ez daiteke Ainhoa etxera etor      ii. Ez da Ainhoa etortzen ahal  
Ainhoa cannot come home

In the rest of the dialects, negation with the modal verbs \**edin* and \**ezan* requires the related word *ezin* 'not be able to':

- iii. Ezin daiteke Ainhoa etxera etor  
Ainhoa cannot come home (in dialects where (i) is \*)

Negating a sentence with the auxiliaries *izan/ukan* requires *ezin*, too:

- iv. Ezin da (du) Ainhoa(-k) etxera etorri  
(where (ii) is \*)

*ezin* can perhaps be analyzed as a *main verb* rather a negative modifier.

In Biscayan (Western) Basque, the main verb *egin* 'do' has replaced the modal verb \**ezan*; in some varieties of this dialect, *egin* is even used on a par with \**edin* 'be able to' with unaccusative verbs. My prediction is that in these varieties, where both forms coexist, negated forms of *egin* will be grammatical (a *main verb* is used as modal), but negated forms of the modal auxiliary \**edin* will not. This is borne out by the data:

- v. Ainhoa ez leike etxera etorri      vi. \* Ainhoa ez leiteke etxera etorri  
neg do (egin) home-adv come      neg be able to (\*edin)  
Ainhoa could not come home      Ainhoa could not come home

- vii. (cf.) Ainhoa ezin leiteke etxera etorri  
neg be able to (\*edin) Ainhoa could not come home

I thank J.I. Markaida and Elena Bengoetxea for these data.

In summary, the contrast in the behavior of the auxiliary verbs *izan/ukan* 'be/have' and the modal auxiliaries with respect to the syntax of operators provides significant evidence for the conclusion that the former must be analyzed as main verbs, whereas the latter cannot be. A second related distributional argument comes from gapping phenomena. I assume that gapping must at least involve a verb and its corresponding INFL element. Main synthetic verb forms (verbs that have undergone V-to-I raising) may be the target of gapping; the same sentences are of course bad if the verbal stems remain *in situ*, and INFL alone is gapped:

- (32) Ainhoa Bilbora    doa   eta Asier Irueara [C [I/V  $\emptyset$ ]]  
           Bilbao-adl goes and Asier Pamplona-adl  
           Ainhoa goes to Bilbao and Asier to Pamplona

Not surprisingly, the auxiliary verbs *izan/ukan* may also be the target of gapping in periphrastic verb forms:

- (33) Ainhoa mendira       joa-n-go   da eta Asier hondartzan  
           mountain-adl go-perf-KO is and       beach-loc  
           gera-tu-ko [C [I/V  $\emptyset$ ]] ( $\emptyset$  = da)  
           remain-perf-KO  
           Ainhoa is to go hiking and Asier to remain at the beach

Periphrastic verb forms with modal auxiliaries, on the contrary, produce marginal sentences when the auxiliaries are gapped:

- (34) ?(?) Ainhoa mendira joan daiteke eta Asier hondartzan  
           mountain-adl go edin  
           [v gera] [C [I  $\emptyset$ ]] ( $\emptyset$  = daiteke)  
           Ainhoa can go hiking and Asier remain at the beach

The facts confirm that *izan/ukan* behave like main verbs, but *\*edin/\*ezan* do not. If, contrary to the evidence, *izan* and *ukan* were regarded as mere spellouts of INFL, the rule of gapping would have to state that INFL alone may gap depending on which elements occupy it. This would require an additional stipulation. In conclusion, the arguments given in this section indicate that the auxiliary verb *izan* and *ukan* are not spellouts of INFL but main verbs, as in (35):



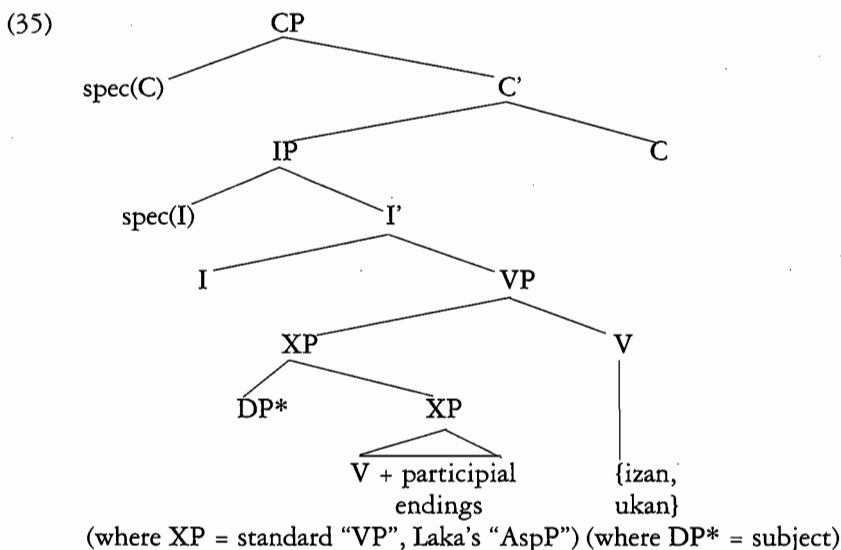

#### 4.2. Some inconsistencies in the aspect phrase hypothesis

Thus far, we have rejected on empirical and theoretical grounds the assumption that the auxiliary verbs *izan* and *ukan* originate under INFL and hence do not head their own VP projection; the distribution and properties of these verbs are similar to those of other synthetic verbs. Turning now our attention to the sister constituent of these two auxiliary verbs headed by the three different participles (the perfect/non-perfect/future participles) (cf. (2)-(4) above), two positions have been considered: it is a VP (Eguzkitza 1986, Goenaga 1980, 1984, Ortiz de Urbina 1989) as generally assumed for English (cf. Chomsky 1986b), or an Aspect Phrase, as in Laka (1990). The first position gives up the possibility of accounting for the presence of the participial morphemes syntactically and assigns them no categorial status. In this section, I concentrate on the second view, although my arguments also hold against the VP position. I point out two deficiencies of Laka's AspP hypothesis: first it makes wrong predictions with respect to coordination, and second the existence of some grammatical PPs that share the same distribution as the non-perfect participle raises some questions about the exact nature of this participle, questions which my hypothesis of section 4.3 will answer.

##### 4.2.1. Unfulfilled predictions

As was emphasized in the presentation of periphrastic verb forms with the auxiliary verbs *ukan* and *izan*, a given form of the auxiliary combines with all the three participles, contrary to what happens in English. If the projection headed by the participles is uniformly an Aspect Phrase, we predict that coordination of any

two different AspPs or participles should in principle be possible on the assumption that only maximal phrases of the same type can be coordinated. This prediction, though, is not borne out by the data. Although coordination of “aspectual” participles is generally barred in declarative sentences, it is possible to coordinate two negated participial constituents (with *ez* functioning as coordinating conjunction and having scope over each of the participial structures). The two participial constituents, however, must be of exactly the same type<sup>9</sup>:

- (36) a. *Ainhoak ez du ez egunkaria eros-i, ez egunkaria irakurr-i*  
*neg has neg paper buy-perf neg paper read-perf*  
 Ainhoa has neither bought the paper nor read the paper
- b. \**Ainhoak ez du ez egunkaria eros-i, ez egunkaria irakur-tze-n*  
*neg has neg paper buy-perf neg paper read-TE-loc*  
 Ainhoa has neither bought the paper nor (is) “reading” the paper
- c. \**Ainhoak ez du ez egunkaria eros-i, ez egunkaria irakurr-i-ko*  
*neg has neg paper buy-perf neg read-perf-KO*  
 Ainhoa does not buy the paper nor (will) read the paper

The ungrammaticality of (36b) and (36c) cannot be attributed to some kind of semantic incompatibility, for there is no principled reason to exclude coordination of constituents specified differently for tense and aspect:

- (37) a. *Ainhoa [went to the store] and [will be back in a minute]*  
 b. *Ainhoa may [have gone to the movie] and [be at home now]*

(37a) involves coordination of two I' (cf. Burton & Grimshaw 1992 and McNally 1992) with different tense specifications; (37b), on the other hand, is an example of VP coordination where the first VP is perfective and the second is not. The same prediction, namely that AspPs should be able to coordinate, fails to obtain in cases of Across-The-Board (ATB) “auxiliary inversion” with a *wh*-operator (see 1.2.2. above (sentences (26a)-(27a))). I assume Williams' (1978) notation for Across-The-Board rule application. In ATB cases, the participles must also be of the same type in order to be coordinated (cf. (39) and (40)):

- (38) a.  $\left\{ \begin{array}{l} [\text{IP I}] [\text{VP}^{\text{DP}_{\text{subject}}} \{ [\text{XP} \dots \text{V-asp markers}] \} \text{V}] \\ [\text{IP I}] [\text{VP}^{\text{DP}_{\text{subject}}} \{ [\text{XP} \dots \text{V-asp markers}] \} \text{V}] \end{array} \right\}$   
           1                  2                                          3                                          4
- b.  $\left\{ \begin{array}{l} [\text{IP Op}_i [\text{IV}]]_j \left\{ \begin{array}{l} [\text{VP } t_i \{ [\text{XP} \dots \text{V-asp markers}] \} t_j] \\ [\text{VP } t_i \{ [\text{XP} \dots \text{V-asp markers}] \} t_j] \end{array} \right\} \text{eta} \end{array} \right\}$   
           1                                          2                                          3                                          4

(9) The examples in (36) are not CP coordination; when negated CPs are coordinated, it is possible to have different lexical subjects even though the inflected verb in the second conjunct may gap:

i. *Ez du Jonex ezer eda-n ez eta (Mirenek) ezer eda-n-go ere*  
*neg has anything drin-perf neg conj Miren-erg anything drink part*  
 John hasn't drunk anything and (Miren) will not drink anything either

- (39) Ainhoa Durangora trenez *bel-du-ko da* eta (Ainhoa) handik mendian Durango-adl train-inst arrive-perf-KO is and hence mountain-loc gora *abia-tu-ko da* up head-perf-KO is  
Ainhoa will arrive in Durango by train and (Ainhoa) will go up the mountains from there
- (40) Nor<sub>i</sub> da<sub>j</sub> [<sub>t<sub>i</sub></sub> Durangora trenez *bel-du-ko t<sub>j</sub>*] eta [<sub>t<sub>i</sub></sub> handik mendian gora who *abia-tu-ko t<sub>j</sub>*]  
Who will arrive in Durango by train and will go up the mountains from there ?
- (41) Ainhoa Durangora trenez *bel-du da* eta (Ainhoa) handik mendian gora Durango-adl train-inst arrive-perf is and *abia-tu-ko da*  
Ainhoa has arrived in Durango by train and will go up the mountains from there
- (42) \*Nor<sub>i</sub> da<sub>j</sub> [<sub>t<sub>i</sub></sub> Durangora trenez *bel-du t<sub>j</sub>*] eta handik mendian gora [<sub>t<sub>i</sub></sub> who *abia-tu-ko t<sub>j</sub>*]  
Who has arrived in Durango and will-go up the mountains from there

By assumption, the bracketed structures (Williams' "factors") must be dominated by the same node; the fact that (42) is ungrammatical suggests that the different participial constituents in (41) and (42) are dominated by a different node (i.e. the values of XP do not coincide in (41)-(42)). The coordination facts presented here cast serious doubt on the correctness of the AspP hypothesis and its claim that the different participles that appear as complements to the auxiliaries *izan* and *ukan* are all dominated by the same node. I will return to these data in section 4.3.

#### 4.2.2. The problem posed by locative PPs

Recall from section 4.1.1 (sentences (3a,b)) that the non-perfect participle that appears as complement to *izan* and *ukan* is formed by the verbal stem, the nominal suffix *te* and the locative postposition *n*:

- (3) a. Ainhoak [egunkaria *ekar-tze-n*] du  
paper bring-TE-loc has  
Ainhoa brings the newspaper (\*is bringing)
- b. Ainhoa [egunkaria *ekar-tze-n*] zuen  
had  
Ainhoa used to bring the newspaper (\*was bringing)

The constituent headed by this non-perfect participle (Laka's AspP) is also licensed as a complement to at least four other different types of verbs: aspectual verbs,

semi-auxiliaries verbs, perception verbs, and epistemic (“connaissance”) verbs (cf. Lafitte 1962, Goenaga 1985)<sup>10</sup>.

- (43) Ainhoa [ardoa *eda-te-n*] has-i da  
wine drink start is Ainhoa has started drinking beer
- (44) Ainhoa [ardoa *eda-te-n*] dabil/dago/ ari da  
walks/stays/ARI is Ainhoa is drinking wine
- (45) Ainhoak [ardoa *eda-te-n*] Asier ikus-i du  
see has-him  
Ainhoa has seen Asier drinking beer
- (46) Ainhoak [pianoa *jo-tze-n*] ikas-i du  
piano play learn has-it  
Ainhoa has learned to play piano

The data in (43)-(46) are reminiscent of English “bare VPs” with *ing*, which I have analyzed as AP gerunds in chapter one (section 1.2.4.1) following Emonds (1990). Let us tentatively reflect these facts by stating that these four types of verbs may subcategorize (in the standard sense) for an AspP of the relevant kind:

- (47) a. *basi* ‘start’, V, +AspP [-perfect]\_\_\_\_  
b. *ibili* ‘walk’, V, +AspP [-perfect]\_\_\_\_  
c. *ikusi*, ‘see’, V, +AspP [-perfect] DP \_\_\_\_  
d. *ikasi*, ‘learn’, V +AspP [-perfect]\_\_\_\_

What is troublesome for this view is the fact that these verbs may also alternatively take certain locative PPs headed by the postposition *-n* (i.e. the same one that attaches to *tze* in examples (43)-(46) above). The set of nouns that may appear in these PPs forms a closed class of 15-20 members or so: *jolasean* ‘at the game, playing’, *bertsotan* ‘at the verses, improvising verses’, *lanean* ‘at work, working’, *dantzian* ‘at the dance, dancing’, *musean* ‘at mus (=card game), playing mus’, *berriketan* ‘at chat, chatting’, etc.

- (48) Ainhoa  $\left\{ \begin{array}{l} \text{lanean} \\ *kantan \end{array} \right\}$  has-i da  
start-perf is  
Ainhoa has started “at work, working”/ “\* at the song, singing”

(10) This situation is parallel to English VP-*ing* but there are some differences; a) epistemic verbs in English don’t take V+*ing* complements; and b) the non-perfect participle also appears in *tough* (Complex Adjectival) constructions in Basque:

i. *Liburu hauek gaitzak dira* [liburutegian topa-tze-n]

book these tough-art are library-loc find-TE-loc These books are tough to find at the library

In Basque the PP participle is perhaps not a true complement to the adjective, but a VP adjunct (extraction is not possible from the participle). If so, then *liburu hauek* may receive a  $\theta$ -role from both the adjective and the participle. Crucially, these two are not  $\theta$ -related, so Emonds’ Revised  $\theta$ -Criterion is respected. Unlike in English, then, no null operator analysis need to be invoked (cf. Chomsky 1981).

- (49) Ainhoa { ametsetan }dabil  
           { \*tristuran }walks  
 Ainhoa is “at dreams, dreaming”/ “\* at sadness, feeling sad”
- (50) Ainhoa { dantzana }ikus-i dut  
           { \*kanta } see-perf have  
 I have seen Ainhoa “at the dance, dancing”/ \* “at the song, singing”
- (51) Ainhoa { bertsoan }ikas-te-n du  
           { \*musika }learn-TE-loc has  
 Ainhoa learns “at verses, improvising verses”/ \* “at the music, playing music”

It may seem too trivial to simply extend the subcategorization frames above to include these special PPs. But further complications arise: these locative PPs can freely conjoin with ten participles, which suggests that they are dominated by the same node.

- (52) Ainhoa [lanean] eta [unibertsitatera joa-te-n] has-i da gaur  
           work-loc and university-adl go start is today  
 Ainhoa started “at work” (= working) and going to the university today
- (53) Lazkao Txiki [bertsoan] eta [istorioak kontatze-n] entzun dut irratian  
           verse-loc and stories tell hear I-have-it radio-loc  
 gaur goizean  
 today morning-loc

This morning I heard Lazkao Txiki “at verses” (= improvising verses) and telling stories on the radio

- (54) Hik [ordenagailua erabil-te-n] eta [musean] ikasi arte, ez daukagu  
       you computer use and mus-loc learn until neg we-have-it  
       zer eginik  
       what do-part  
 Until you learn to use the computer and “at mus” (= playing mus), we  
 have nothing to talk about

If one regards the coordinated maximal projections as PPs and AspPs respectively, these distributional similarities are purely accidental and puzzling. If, on the other hand, based on the paradigm above, one regards the two as PPs (a natural position since they are *both headed by the locative postposition n*), the coordination facts follow and nothing needs to be stipulated. What emerges is an apparent paradox: what was considered a pure VP in standard analyses and more recently termed AspP by Laka has the external distribution of a certain kind of locative PP, even though the internal structure of the constituent looks like the verb is the selectionally dominant head (e.g. takes accusative objects). The unravelling of this apparent paradox is the subject matter of the next section to which I now turn.

### 4.3. Aspect markers are lexical heads

#### 4.3.1. *The Non-Perfect Participle as a PP*

The realization that *ten* participles are PPs, far from being a final solution in itself, raises some interesting questions for the standard theory of subcategorization, which holds that heads select maximal phrases. To be more explicit, consider (55) and (56):

- (55) Ainhoak \*lanean / \*jolasean / \*dantzán du  
 work-loc game-loc dance-loc has-it  
 Ainhoa has \*‘‘at work’’, \*‘‘at the game’’, \*‘‘at the dance’’ (= \*works,  
 \*plays, \*dances)

- (56) Ainhoak egunkaria ekar-tze-n / irakur-tze-n du  
 -E paper bring-TE-loc read-TE-loc has  
 Ainhoa brings / reads the newspaper

Since the closed class of locative PPs and the non-perfect *ten* participles share the same distribution as complements to aspectual/semiauxiliary/perception/epistemic verbs as shown in 4.2.2 above (assuming that subcategorization is for XPs), one could mistakenly conclude that they are both subcategorized for in the same way, and hence must always have the exact same distribution. The contrast between (55) and (56) shows that this is incorrect: although the four types of verbs studied in the previous section may license both grammatical PPs and *ten* participles, the grammatical locative PPs cannot be complements to the auxiliary verbs *izan* and *ukan*<sup>11</sup>.

At a purely intuitive level, (55) must be ungrammatical because it lacks a true verbal element, contrary to what happens with *ten* participles. Here is the paradox: the internally selectionally dominant head, the verb, seems to be selected as such from the outside, yet the maximal projection dominating it is a PP. Although this paradox is problematic for a standard view of subcategorization (which asserts that c-selection is only selection of XPs), it is exactly what we expect in the approach to subcategorization that I have taken in this article following ideas of Baltin (1989) and Emonds (1990): subcategorization reduces to selection of heads, and the structural head X of the XP which minimally contains it need not correspond to the selected head, as was shown to be the case in nominalized clauses in chapter two.

##### 4.3.1.1. *The non-perfect participle as complement to auxiliary verbs*

In this light, let us implement the idea that the auxiliary verbs *izan* and *ukan* select a verbal head together with a grammatical formative, namely the feature [-completed] in the case of the non-perfect *ten* participles:

(11) Incidentally, this contrast also shows that the alternative of considering that both grammatical locative PPs and *ten* participles are dominated by an AspP node is not viable. It would need to stipulate that the locative postposition is also of category Asp and can take a DP complement (!), and that subcategorization of XPs can analyze the internal structure of XP.

(57) *izan/ukan*, V, + V<sup>^</sup>[-completed]

Since the feature [-completed] is not a feature on verbal stems *per se*, some other element must be generated to minimally satisfy (57). Two options arise: a) either a full clausal structure is generated with a non-perfective inflected finite verb (= [CP [IP INFL [vP V]] COMP]). This is excluded *inter alia* because the "main" subject of *izan/ukan* would not receive any  $\theta$ -role (auxiliaries don't assign  $\theta$ -roles to their subjects); or b) the insertion of a grammatical formative specified as [-completed] can be projected in connection with (attached to) the verb. Recall from chapter two that there is indeed a morpheme specified as [-completed], namely the nominalizing suffix *te*:

(58) *te*], N, +V<sup>^</sup>  $\left\{ \begin{array}{l} \{ (V = +ACTIVITY) \} \\ \{ N = [-completed] \} \end{array} \right\}$

By (58), the nominal suffix *te* can be generated as a sister to V in order to satisfy (57); the late insertion option of *te* (that is, ignoring the parenthesized material), is moreover predicted, since no semantic constraint on the verb is expressed in (57).

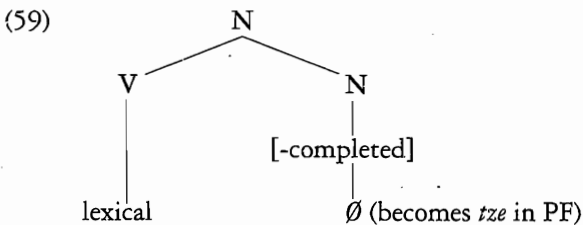

If nothing else is said, the subtree in (59) would project into a full NP and DP structure. This would conflict with the  $\theta$ -Criterion since it would presuppose the existence of an additional DP-subject internal to the nominalized structure which would leave no  $\theta$ -role available for the DP-subject of the sentence (Koopman & Sportiche's NP\* position):

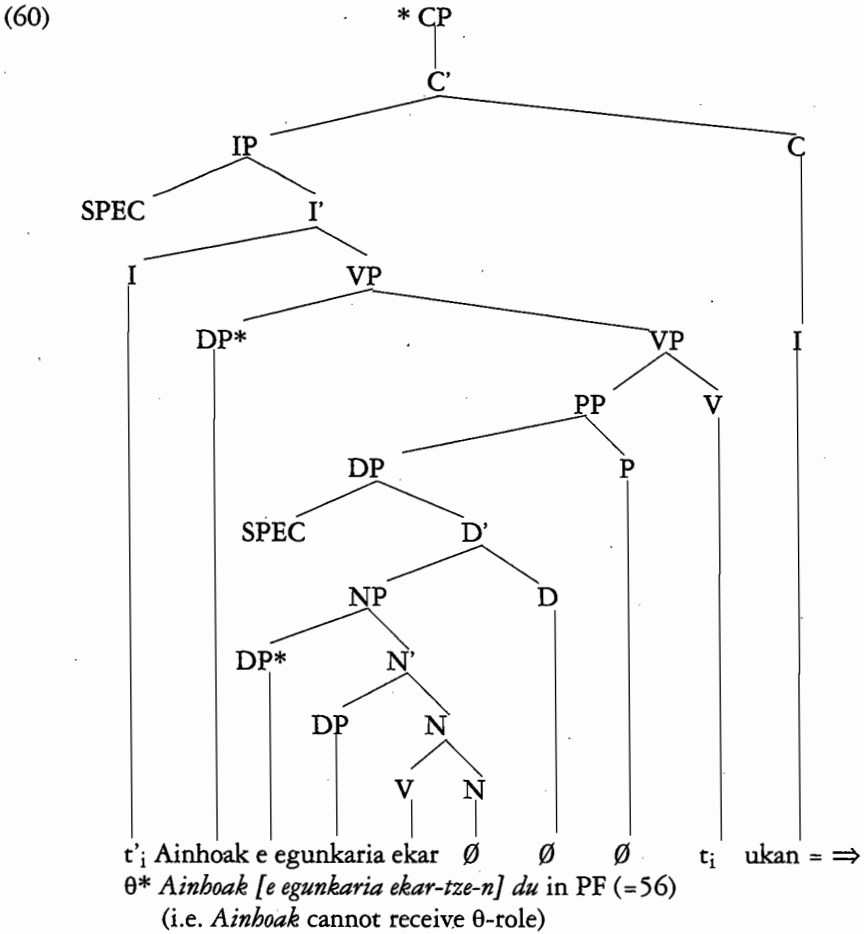

Crucially, auxiliary verbs do not assign  $\theta$ -roles to their subjects; if they did, then simple sentences with auxiliary verbs and non-perfect participles should be treated as cases of control, which is incorrect as we shall see below in 4.3.1.2.

I suggest that *pace* the  $\theta$ -Criterion, Emonds' Minimal Structure Principle (cf. chapter one, section 1.2.3) licenses the insertion of an empty P in (61) at D-S; notice that (61) is a more compact structure than (60), lacking a full DP projection.



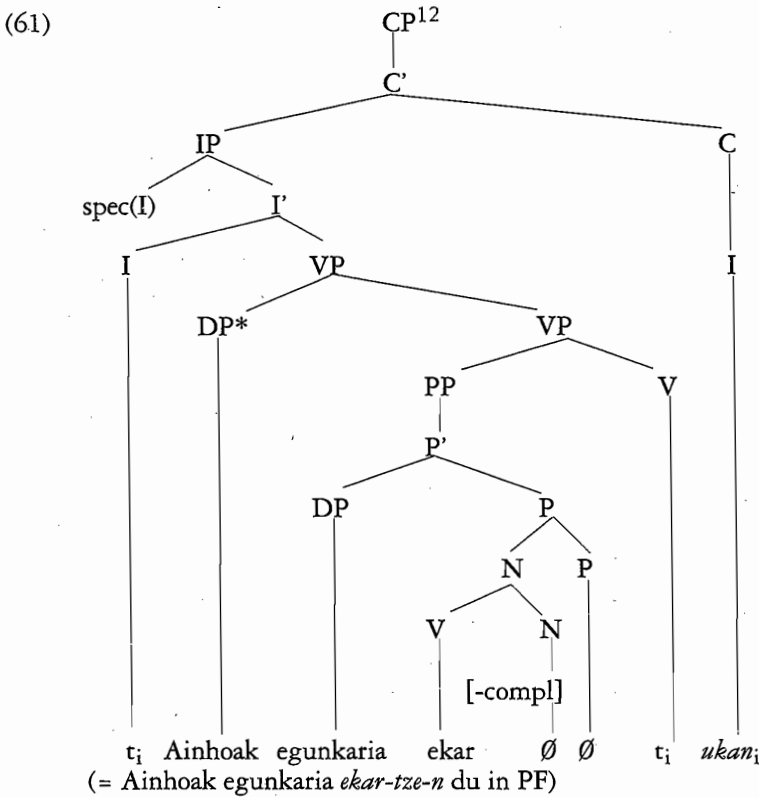

Generating (61) minimally satisfies the subcategorization frame in (57) because only one maximal complement phrase is generated (as opposed to a full clause). Since *te* is not restricted to any class of verb and its insertion is induced by the syntactic feature +[-completed] in (57), it is predicted that it will remain empty until PF. The empty P node will be filled by the unmarked locative postposition *n* in PF, if the following lexical entry is assumed:

- (62) *n*, P, LOCATION, +N (\_\_\_) (N = [-completed])

The last parentheses imply that the complement to the *n* may be specified with the feature [-completed]. I thus derive the VP-like behavior and the PP distribution of *ten* non-perfect participles: the verb in (61) and all similar cases is the L-head of the PP at D-S and S-S, it selects all the complements inside the PP structure with no interference by the empty N and P by virtue of *Empty Head Transparency* (chapter one, 1.2.3), and is able to assign accusative case to a potential DP complement (the *V* constitutes a sister to DP; cf. 1.2.3).

(12) I assume that the DP subject originates as an adjunction to the lower PP (the "main" VP in standard analyses), as in Koopman & Sportiche 1991), and adjoins to the VP to receive case from INFL. I have omitted the trace of the subject adjoined to the lower PP for ease of exposition.

See chapter one, sections 1.3.4 and 1.3.5 for arguments that the INFL is initial in Basque and that the unmarked order results from a substitution movement of INFL into COMP.

4.3.1.2. *Non-perfect participles cannot be clausal*

A theory like Baker's (1988) prevents deep "syntactic" and surface "morphological" subcategorization from interacting with each other in the manner described in the preceding section to satisfy subcategorization features in a minimal way. As a result, it is forced to choose between two alternatives: a) either *ten* participles are not PPs (i.e. are not formed by a nominalizing suffix and the locative morpheme) and are selected as AspPs; this runs counter the evidence from coordination presented in 4.2.1. b) Or a maximal phrase must be generated for every morpheme, and hence PP participles are of the form [PP [DP [NP [VP V] N] D] P], with all heads ending up on P as a result of head-movement or incorporation triggered by morphological subcategorization, in compliance with the Mirror Principle<sup>13</sup>. Position *b* corresponds *grosso modo* to the tree given in (60) above, which I rejected on theoretical grounds: if the  $\theta$ -role assignment of the main verb is internal to the PP-structure, we are forced to posit that periphrastic verb constructions are obligatory control structures. But in the case at hand, this kind of approach also conflicts with Subjacency. Some extraction data illustrate this point.

The verb *etzan* 'lie, consist of' subcategorizes for locative PPs (+P, LOCATION in our terms). The locative P may be a sister to a normal DP or "clausal" DP:

- (63) a. Udalaren etorkizuna [pp [DP finantzaketaren  
 local council-gen future financing-gen  
 konponketa]-a] -n] datza  
 solving -art-loc lies  
 The future of the local council lies [pp in [DP the solution of the  
 financing issue ]]
- b. Udalaren etorkizuna [pp [DP [NP *e* finantzaketaren arazoa  
 konpon-tze]-a]-n] datza  
 problem solve-TE -art-loc lies  
 The future of the local council lies [pp in [DP solving the problem  
 of financing ]]

Extraction of a complement from these clausal PPs is ungrammatical even though the PP itself is a complement to the main verb:

- (64) \* Zer<sub>i</sub> datza udalaren etorkizuna [pp [DP t<sub>i</sub> [D' [NP *e*  
 what  
 t<sub>i</sub> konpontze]-a]-n] ?  
 What<sub>i</sub> does the future of the local council lie  
 [pp in [DP [NP solving t<sub>i</sub> ]]] ?

The ungrammaticality of (64) can be accounted for along the lines of Artiagoitia (1992b). Movement from inside the NP to spec(D) is legitimate: although D, a non-lexical category, fails to L-mark NP, only one blocking category and barrier is

(13) *The Mirror Principle*: Morphological derivations must directly reflect syntactic derivations (and vice versa) (Baker 1988: 13).

crossed (=NP), which is permitted by the Subjacency Condition of Chomsky (1986b) (cf. chapter one: 1.1.4). Artiagoitia (1992b) assumes that the category P does not qualify as "lexical" in Basque, and hence fails to L-mark its DP complement. The latter becomes a blocking category and a barrier, and PP inherits barrierhood from DP. Therefore the sentence is ruled out by the Subjacency Condition: two barriers, DP and PP, are crossed (crucially, the spec(P) position is not a possible escape hatch in Basque)<sup>14</sup>.

Extraction from *ten* participles, on the other hand, is always grammatical (as though extraction were from a "bare VP"):

- (65) a. Proiektu honek [finantzaketaran arazoa konpon-tze-n] du  
 project this financing-gen problem solve-TE-loc has  
 This project solves the problem of financing  
 b. [<sub>IP</sub> Zer<sub>i</sub> [<sub>Γ</sub> konpon-tze-n<sub>i</sub>; du<sub>k</sub> [<sub>VP</sub> proiektu honek [<sub>PP</sub> t<sub>i</sub> t<sub>j</sub>] t<sub>k</sub>? ]]]  
 c. [<sub>IP</sub> Zer<sub>i</sub> [<sub>Γ</sub> du<sub>k</sub> [<sub>VP</sub> proiektu honek [<sub>PP</sub> t<sub>i</sub> konpon-tze-n] t<sub>k</sub> ]]]?  
 What does this problem solve ?

In (65b) extraction is hard to test because the participle and auxiliary verb are adjacent to the operator (= the main verb/participle is adjoined to the auxiliary *ukan* in INFL) and it could be a case of pied-piping. But in (65c) only the auxiliary is in INFL, and extraction is grammatical. This provides evidence that the PP structure of the *ten* participles doesn't contain any further phrasal structure<sup>15 16</sup>.

It should be pointed out that even if only a [<sub>PP</sub> [<sub>NP</sub> [<sub>VP</sub> V] N] P] internal phrasal structure were assumed for a PP participle (with no overt DET/DP nodes present), a Baker style analysis would still generate too much structure: granted that the nominal affix *te* may L-mark VP, NP will not be L-marked by P and will constitute a blocking category and a barrier; PP will also become a barrier, thus predicting that extraction from participles should be ungrammatical. Extraction is also possible from PP participles that are complements to other verbs:

- (66) a. Ze egunkari; dabil Ainhua [<sub>PP</sub> t<sub>i</sub> irakur-tze-n] ?  
 which paper walks read-TE-loc  
 Which paper is Ainhua reading ?

(14) Note that extraction of nominalized DPs in object position is possible in general, as discussed in chapter two. The qualification of P as "non-lexical" for Basque is amply justified in Artiagoitia (1992b). See also Johnson (1988). My regarding P as non-lexical for the purposes of L-marking does not imply that the category P is functional, but rather that it is quite unlike the major lexical categories (N, A, V). One way-out is to define L-marking as  $\theta$ -government by a lexical category which is *positively specified* for some categorial feature, thus excluding P ([-N, -V]) as an L-marker. Another variant of this position is to assume that the negative values of major categorial features are unspecified and simply filled in by default after S-S.

(15) The article, which usually appears in singular locative PPs, is absent in PP (*ten*) participles. The bare *n* postposition is traditionally taken to be a remnant of the old indefinite locative (*ta-n* in modern Basque). However, in formal terms, if only P (without D) is present, it follows that only the true (locative) postpositional element will appear, namely *n*. See note 17.

(16) The reader should bear in mind that Baker's theory of government explicitly gives up on the notion that government and subjacency can be treated in a unified manner: "the cost of this simplification... the abandoning of... a definition of barrier which will also be appropriate as a definition of "bounding node" for Subjacency" (Baker 1988: 57). As a result, Baker is forced to adopt Chomsky's (1977) and Rizzi's (1982) version of Subjacency, where bounding nodes are stipulated for each language. Under this view of Subjacency, the problem for a Baker-style approach still persists since PP and NP/DP are "bounding nodes" in Basque.

- b. Ze egunkari<sub>i</sub> has-i zara [pp t<sub>i</sub> irakur-tze-n] ?  
 start-per are-you  
 Which paper have you started reading ?
- c. Ze egunkari<sub>i</sub> ikus-i duzu Ainhoa [pp t<sub>i</sub> irakur-tze-n]?  
 see-perf have-you  
 Which paper have you seen Ainhoa reading ?
- d. Ze musika tresna<sub>i</sub> ikas-i-ko duzu [pp t<sub>i</sub> jo-tze-n] ?  
 musical instrument learn-perf-ko have-you play-TE-loc  
 Which musical instrument will you learn how to play? ("playing")

Since the PP participles are all complements of a verb, they are all L-marked in the sense of Chomsky (1986b). The only potential barrier is the main VP, but adjunction to it voids the barrierhood effect. To sum up, the possibility of extracting from PP participles supports the analysis given in (61). An analysis which assumes the existence of a phrasal node for every morpheme present in the participle would not be able to account for the grammaticality of extraction from *ten* PP participles.

#### 4.3.1.3. Non-perfect participles and grammatical pps revisited

The subcategorization frame for auxiliary verbs in (57) obviously predicts that the only complement to *izan/ukan* 'be/have' will be the non-perfect PP participle.

The question still remains as to why these PP participles *and* some locative PPs can co-occur as complements to the perception/ semiauxiliary/ aspectual/ epistemic verbs (but not as complements to the auxiliaries *izan* and *ukan*). We would like to predict this from the lexical entries for these four types of verbs. For the non-perfect participles, we can simply state that these verbs subcategorize like auxiliaries:

- (67) a. *basi* 'start', V, + V<sup>^</sup>[-completed]  
 b. *ibili* 'walk', V, + V<sup>^</sup>[-completed]  
 c. *ikusi*, 'see', V, + V<sup>^</sup>[-completed], N  
 d. *ikasi* 'learn', V, + V<sup>^</sup>[-completed]

As far as the grammatical locative PPs (where "grammatical" means "not associated with a purely semantic feature in their lexical entry"; cf. Emonds (1985) and chapter one) are concerned, we would like to capture the intuition that these PPs are "grammatical" in the sense that they form a closed class, i.e. that they have some property or feature in common with the non-perfect participle even though they lack a true verbal head. The obvious option is to assume that these nouns (and subsequently locative PPs), besides their "regular" entry, are also marked in the lexicon with some syntactic feature akin to that borne by *te*, namely [-completed]:

- (68) [*lan*], [*jolas*], [*mus*], ..., N, ([-completed])

The facts are slightly more complicated, because when functioning as grammatical PPs, each member of this closed class idiosyncratically takes the form of an indefinite locative PP or a singular locative PP, but not both. In other words, for

each grammatical use of the PP (and ultimately, the noun), we must specify whether the noun is [+definite, +singular] or [-definite]:

- (69) [*lan*], N ([-completed], [+def, +sing])
- [*dantz-a*], N, ([-completed], [+def, +sing])
- [*bertso*], N, ([-completed], [-def]) ...

Thus, (69) accounts for why, in the grammatical use with the locative postposition, we get *lane-a-n*, *dantz-a-n* (literally 'at the work', 'at the ball') but *bertso-ta-n* ('at verses'). The ending *an* is traditionally considered the singular locative and *tan* the indefinite form<sup>17</sup>.

We can now propose a subcategorization frame for aspectual/ semiauxiliary/ perception verbs that will predict the cooccurrence of non-perfect participles and locative PPs with grammatical nouns:

- (70) a. aspectual/ semiauxiliary /epistemic verbs:  
       V, + { {V} } ^[-completed]  
           { {N} }
- b. perception verbs  
       V, + { {V} } ^[-completed], N  
           { {N} }

(70a) will be minimally satisfied by a non-perfect participle as in (61) above, or else by a grammatical PP as in (71); (70b) is satisfied by a regular DP and either (61) or (71):

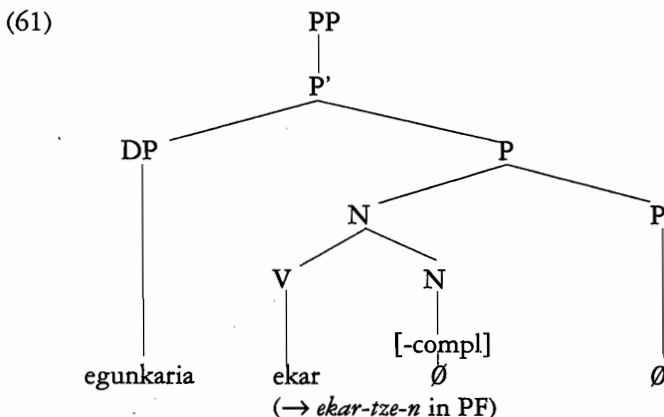

(17) It is standard to consider the *a* in *an* as the article; the locative is the only P where the singular article is overt. The definite plural form of the locative is *e-ta-n*:

i. *hiru bertso-ta-n* 'in three verses'      ii. *hiru bertso-e-ta-n* 'in the three verses'

I assume here that *ta* is of category D (for D=[-singular, -definite]). *eta* must also be of category D (when D=[+def, -sing]).



We have now derived why these verbs can indistinctively have either kind of PP as their complement, whereas *izan/ukan* can only have PP participles. Using a syntactic feature in the lexicon to represent the closed class of nouns that may form locative PPs that cooccur with participles seems to capture the notion that what is specific to Basque is the existence of a set of grammatical PPs. I have also proposed that the presence of this feature induces late insertion of the determiner and the locative postposition (if not of the entire PP). If this feature (i.e. [-completed]) is truly syntactic, it should have some different reflex for the behavior of lexical PPs and grammatical PPs. Appositive structures with the pronoun *bera* support this claim. In Basque, every non-null DP can be modified for emphatic purposes by the pronoun *bera* 'he, she, it' if the latter immediately follows the DP; if the modified DP is embedded in a PP, so must be the pronoun:

- (73) a. *Ainhoa bera ager-tu da*  
           she appear is  
           Ainhoa herself has appeared  
   b. *Liburua etxean bertan utz-i dut*  
       book home-loc it-loc leave I-have-it  
       I have left the book at home "itself" (= right at home)  
   c. *Ainhoa-k liburua etxera bertara erama-n du*  
       book home-adl it-adl bring has-it  
       Ainhoa (has) brought the book home "itself" (= right home)

However, the kind of locative PPs studied in this section are incompatible with these appositive structures:

- (74) a. \**Ainhoa lanean / dantzian bertan has-i da*  
           work-loc dance-loc it-loc start-perf is  
           Ainhoa has started at work / at the dance "itself"  
   b. \**Ainhoak lanean / dantzian bertan ikas-i du*  
       work-loc dance-loc it-loc study-perf has  
       Ainhoa has learned at the work / dance "itself"  
   c. \**Ainhoa lanean / dantzian bertan ikus-i dut*<sup>19</sup>  
       work-loc dance-loc it-loc see-perf have  
       I have seen Ainhoa at the dance/ at the work itself

If the well-formedness condition on this appositive structure requires that the modified XP have full lexical content to be a referential expression at D-S and S-S (e.g. because coindexation of the DP and the pronoun is otherwise impossible), the ungrammaticality of (74) follows since the DET node (and the P node too) under these grammatical locative PPs remains empty until PF, due to the presence of the syntactic feature [-completed]. No explanation could be simpler for the absence of appositive PPs with these kind of locative PPs and their lack of referentiality. Having fully elaborated on the issue of how *tzen* participles result in PPs even

(19) The sentences are grammatical under the lexical PP interpretation: "at the work place, at the ball", but this interpretation doesn't imply that Ainhoa was actually working or dancing.

though their L-head is indeed the verb and they are selected externally as V-projections, I now turn to the analysis of the perfect and future participles.

#### 4.3.2. *The perfect participle*

Once it has been established that projections headed by the non-perfect participle are indeed projections of lexical heads (a combination of N-P), an immediate question arises: does something similar also hold of the perfect and future participles? I suggest here that such is the case: perfect participles are projections of the category A (adjective), and future participles (to be studied in the section 4.3.3) are projections of the category P. Recall how the verb combines with the perfect participle to form the tenses that translate as the present perfect and the simple past in English:

- (2) a. Ainhoak egunkaria *ekarr-i* du  
 Ainhua-E paper bring-perf has  
 Ainhua has brought the newspaper  
 b. Ainhoak egunkaria *ekarr-i* zuen  
 had  
 Ainhua brought the newspaper

The *i* ending is one of the variants of the perfect morpheme studied in chapter three. A deep analysis of the perfect morpheme there showed the existence of a fairly abstract paradigm: the perfect morpheme may form derived nominals and derived adjectives when subject to D-S lexical insertion, in which case the morpheme absorbs the DP object of the verb to which is suffixed. The perfect morpheme may be also inserted after S-S; in this case it gives rise to nominalizations of the perfective type with internal "clausal" structure (the verb is the L-head):

(75)

|           | D-S                        | S-S                                                    |
|-----------|----------------------------|--------------------------------------------------------|
| Noun      | derived Ns<br>(absorption) | Nominalized Clauses<br>perfect morpheme = [+completed] |
| Adjective | derived As<br>(absorption) | ??                                                     |

As pointed out in chapter three, this abstract paradigm has a gap: we expect that there can be a late-insertion option of the perfect morpheme in its adjectival use. In this case, the AP will be selected externally as a V-projection, and the adjectival morpheme will not be present until PF, thus allowing the V to be the L-head of this maximal projection. Furthermore, we predict that the adjective morpheme will be associated with the same feature [+completed] as in nominalized clauses. I assume here that the examples in (2) instantiate the existence of such APs. The auxiliary verbs *izan* 'be' and *ukan* 'have' select as in (76), and the internal structure of their complement at D-S and S-S is as in (77):

- (76) *izan/ukan*, V, +V<sup>^</sup>[+completed]



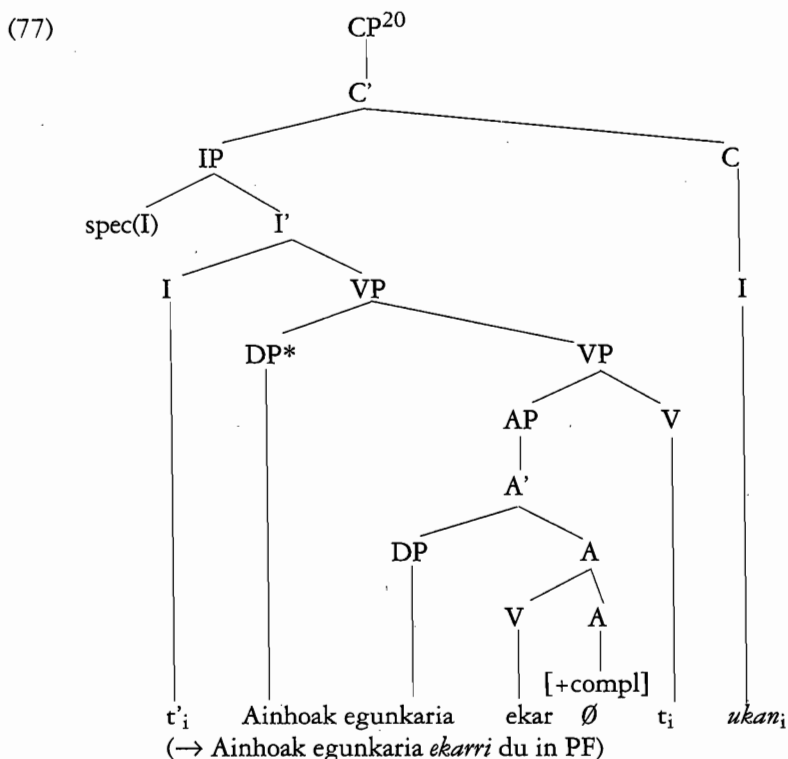

The existence of adjectival participles is a welcome prediction of the framework assumed here. Additional support for (77) is provided by the fact that in some dialects perfect participles may optionally show number agreement with the object DP when selected by *ukan* (i.e. with transitive verbs) or with the subject DP when they are selected by *izan* (i.e. with unaccusative verbs). This behavior is typical of predicative APs with the copula *izan* 'be':

- (78) a. Nire lagun-a(k) jatorr-a(k) da (dira)  
 my friend-art(pl) cool-art(pl) is (are)  
 My friend(s) is (are) cool (plural)
- b. Nire lagun-a(k) Baionan ego-n-a(k) da (dira)  
 -loc stay-perf-art(pl) is (are)  
 My friend(s) have been (plural) to Bayonne
- c. Ainhoak edalontzia(-k) apur-tu-a(-k) du (ditu)  
 glass(-es) break-perf-art(pl) has  
 Ainhoa has broken (plural) the glass(-es)<sup>21 22</sup>

(20) I assume that DP\* originates adjoined to the lower AP. Cf. note 12.

(21) This sentence can also be interpreted as meaning "Ainhoa has the glasses broken", with *du/ditu* as main verbs and *apurtua(-k)* as secondary predicates. Under this interpretation, Ainhoa has not necessarily broken the glasses herself (the implication is that the glass(es) belong(s) to her). The two readings are disambiguated with a wh-question about the subject:

If (77) is the correct structure, then, the following lexical entries (a simplified version of the ones given in chapter three) predict all the occurrences of the perfect morpheme. Moreover, they also predict the non-existence of a passive in Basque:

- (79) *Basque perfect morpheme*
- |                    |   |                                       |
|--------------------|---|---------------------------------------|
| $i/n/tu$ , A, +V__ | } | {(+N, STATE {V = +ACTIVITY /MOTION})} |
|                    |   | { A = [+completed] }                  |
| $i/n/tu$ , N, +V__ | } | {(+N, STATE {V = +ACTIVITY /MOTION})} |
|                    |   | { N = [+completed] }                  |

What is missing in the Basque adjectival value of the perfect morpheme subject to late insertion is the absorption feature that gives rise to verbal passives.

#### 4.3.3. *The future participle*

Given the analysis of the non-perfect participle in section 4.3.1, the analysis of the future participle as a projection of the category P seems unproblematic. In most dialects, the future participle is formed by attaching the perfect morpheme and the postposition *ko* to a verb stem :

- (4) a. *Ainhoak egunkaria ekarr-i-ko du*  
 Ainhoa-E paper bring-perf-KO has  
 Ainhoa will bring the newspaper
- b. *Ainhoak egunkaria ekarr-i-ko zuen*  
 bring-perf-KO had  
 Ainhoa would bring the newspaper (= was to bring the newspaper)

Recall from the previous chapter that *ko* is a grammatical postposition that attaches to postpositional phrases and *also* attributive bare NPs when they occur DP-internally:

- i. *Nork apur-tu-a du edalontzia?*  
 who-erg break-perf-art has glass  
 Who has broken the glass? (\*Who has the glass broken?)

The adjectival interpretation of the participle is ruled out because the derived adjective stands between the operator in spec(I) and the verb in INFL. The other interpretation is possible as a subcase of participial adjunction.

(22) The addition of the article to the present perfect seems to imply some difference in meaning according to Lafitte (1962: 384-5) (i.e. "achievement qualitatif", "achievement subjectif"):

- i. *Piarres ikus-i duka?* ii. *Piarres ikus-i-a duka?*  
 Have you seen Piarres? Have you already seen Piarres?

Sentence (78b) should be glossed as "... have been to Bayonne *once at least*" (= so-called *experiential perfect*). Other examples mentioned by Lafitte don't really involve the absence/presence of the article in the present perfect tense, but rather a contrast between the present perfect and the corresponding derived adjective with the copula *izan*:

- iii. *(Piarres) eror-i da* fall-perf is  
 (Piarres) has fallen ("est tombé")
- iv. *(Arbola) eror-i-a da* (The tree) fall-perf is  
 (The tree) is fallen ("es par terre")

The latter example is the equivalent of the Southern Basque *eroria/erorita dago* (cf. Spanish "está caído/por los suelos" and, especially, chapter three, section 3.3.1). In the case of the simple past, Lafitte suggests that the difference in meaning brought about by the addition of the article (= material achievement) translates best as the French pluperfect.

- (80) a. Ainhoak [*etxera-ko* autobusa] har-tu du  
           home-adl-ko bus take has-it  
           Ainhoa has taken [the bus for home]  
       b. Ainhoa [*bibotz one-ko*] emakumea da  
           heart good-ko woman is  
           Ainhoa is a woman of good heart

Crucially, the future marker *ko*, traditionally referred to as a "locative genitive" (cf. Lafitte 1962), alternates, depending on the dialect, with the other genitive postposition in Basque, namely *ren* ("possessive genitive"), which can only attach to DPs:

- (81) a. Ainhoak egunkaria *ekarr-i-ko* / *ekarr-i-ren* du  
           Ainhoa will bring the paper  
       b. Ainhoa etxean *ego-n-go* / *ego-n-en* da  
           home-loc stay is  
           Ainhoa will be/stay at home  
       c. Ainhoa etxean *geldi-tu-ko* / *geldi-tu-ren* da •  
           remain  
           Ainhoa will remain home

I take this as evidence that the future participle is a PP headed by *ren/ko*; the alternation between the two Ps shows further that the participle contains a nominal element. I propose that future participles have the structure diagrammed in (83), predicted by the subcategorization properties of the auxiliary verbs and the relevant entries for the genitives in (82):

- (82) a. *izan/ukan*, V, +V<sup>^</sup>[+future]<sup>23</sup>  
       b. *ko/ren*, P, +N(\_\_\_\_, {P = [+future]})  
           [where the parenthesized option (...) corresponds to the aspectual use of the postpositions]

(23) The qualification of the feature [+future] as aspectual is far from precise; the feature [-realized] is perhaps more accurate (cf. Eguzkitza 1986). In the Basque verbal paradigm, I take [+future] to indicate that the event denoted by the verb always takes place after the previously introduced point (whether this is in the present or the past). The event itself is unrealized (cf. Goenaga 1980, who equates the future tenses in Basque to the modal auxiliaries). I will assume here that the event designated by a single verb can be perceived as being realized (in which case it can be perfective or non-perfective) or as unrealized. A future perfect (*I will have arrived*) is basically a future tense, an unrealized event (*to have arrived* is unrealized).



- (85) a. ?Baztandarrek M. Izetari gaur omenaldia egi-*te*-ko diote  
 Baztan-people-E -D today homage do-TE-KO have  
 b. Baztandarrek M. Izetari omenaldia egi-*n*-go diote  
 -perf-KO  
 People from Baztan will pay a tribute to M. Izeta today

One possible explanation for the use of the perfect morpheme is that it is the default empty N because it is more “specific”; that is, it has three different variants depending on the verb stem (*i/n* for native stems, *tu* otherwise), whereas *te* (and its phonologically conditioned variant *tze*) is exceptionless.

It should be pointed out that neither (4) nor (84b/85b) have a perfective future interpretation. This is a consequence of the fact that the features of the structural head always prevail over the features of the non-head. I elaborate on this notion in section 4.3.4.

4.3.4. *Feature percolation: coordinating solutions*

We arrive then at the following picture: the auxiliaries *izan* and *ukan* select the three different kind of participles as V heads together with some syntactic (aspectual) feature. By the Minimal Structure Principle (*pace* the  $\theta$ -Criterion), a single maximal phrase is projected at D-S which contains a verb, the lexical heads that bear the relevant aspectual feature and, when necessary, some grammatical formatives which support the insertion of the aspectual features (the perfect nominal morpheme in the future participle)<sup>24</sup>:

- (86) *izan/ukan*, V, +V<sup>^</sup>[ $\alpha$ F(aspect)]  
 (where [ $\alpha$ F(aspect)] = [+/-completed], [+/-realized/ future])

- (87) a. Perfect Participle

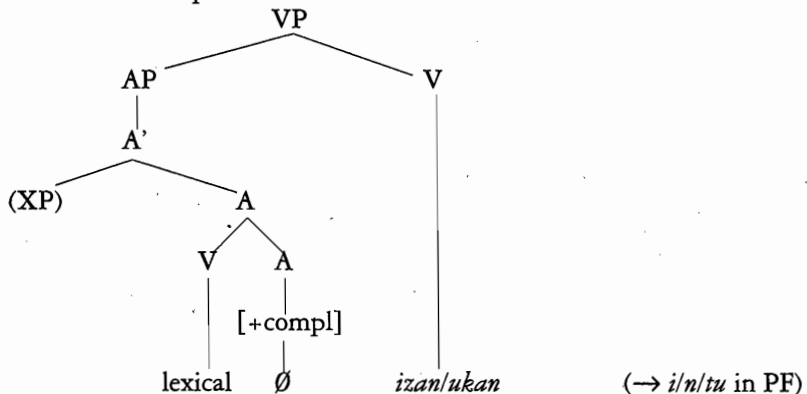

(24) This reduced to +V by the *Aspect Condition* in Arriagoitia (1992a, ch. five), a universal requirement of V-occurrences:

i. *Aspect Condition*: Every XP whose L-head is a verb must be uniquely specified for aspect features in the domain of an extended projection of X

The notion of “extended projection” was taken from Grimshaw (1992):

ii. X is the extended head of Y, and Y the extended projection of X, iff:  
 a) Y dominates X  
 b) Y and X share all categorial features  
 c) all nodes intervening between X and Y share all categorial features

## b. Non-perfect Participle

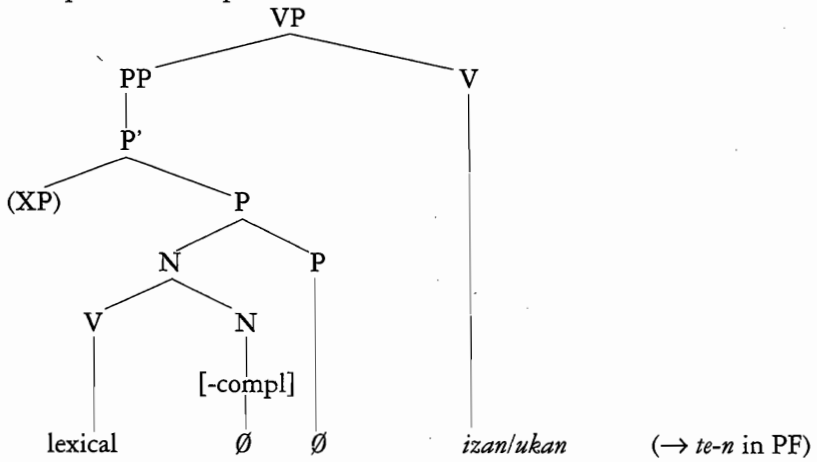

## c. Future Participle

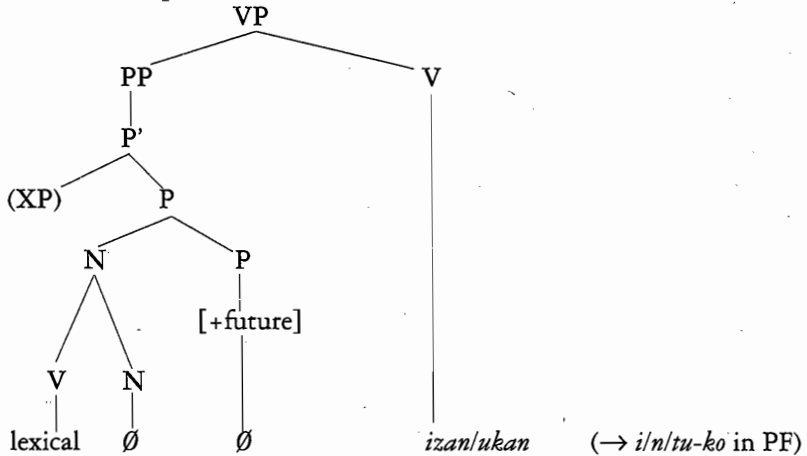

In all the cases, the double insertion level hypothesis predicts that the syntactic heads that realize the features (and the empty noun and P heads associated with them) will not be inserted until after S-S. At both D-S and S-S the verb is the L-head of the maximal phrase, and is able to select its complements and assign accusative case to a DP of which it *constitutes a sister* if required. The empty heads do not induce any minimality effect by *Empty Head Transparency*:

- (88) *Empty Head Transparency*: Under the same  $Y^2$ , empty heads induced by subcategorization distinct from the L-head are transparent in the syntax (where transparent = don't govern and don't block government)

This means e.g. that if verbal heads in aspectuals and  $V^*$  constructions all undergo *head-agreement* as proposed in Chomsky (1986b), these intervening heads will not block coindexing (cf. also Zagana 1988a):

- (89)  $[_{XP} \dots V^2_i (-[Y \emptyset]) -[X \emptyset]] V_i$   
 ( $V_i = izan$  and  $ukan$ ;  $V^2 =$  main verb;  $[Y \emptyset], [X \emptyset] =$   
 any verbal morpheme that remains null at D-S and S-S)

As for the aspectual morphemes in the configurations in (87a, b, c), only their categorial label and their syntactic feature (induced by subcategorization) are present at (D-S and) S-S; at this level, the features of the head percolate to the next node up and, ultimately, to the maximal projection, as proposed in Lieber (1992):

- (90) *Head Percolation*: Morphosyntactic features are passed from a head morpheme to the node dominating the head. Head Percolation propagates the categorial signature<sup>25</sup> (Lieber 1992: 92)

In the case of the perfect participle (=AP) and the future participle (=PP), this is straightforward. The feature [+completed] of the nominal affix in the future participle cannot percolate because the feature of the head does. In the case of the non-perfect participle (=PP), the empty P node determines the syntactic category of the XP, but since no syntactic feature is associated with the empty P at S-S, the feature [-completed] on the non-head *te* percolates to P, according to the second percolation convention of Lieber (1992):

- (91) *Backdrop Percolation*: If the node dominating the head remains unmarked for a given feature after Head Percolation, then a value for that feature is percolated from an immediately non-head branch marked for that feature. (Lieber 1992: 92)

The [-completed] feature of the non-head that has percolated to P will percolate from there to PP by (90). I assume that all XPs containing a verb which is an L-head *must* be specified for aspect<sup>26</sup>. Granted that, then the S-S representations of the participles that are input to LF will look as follows:

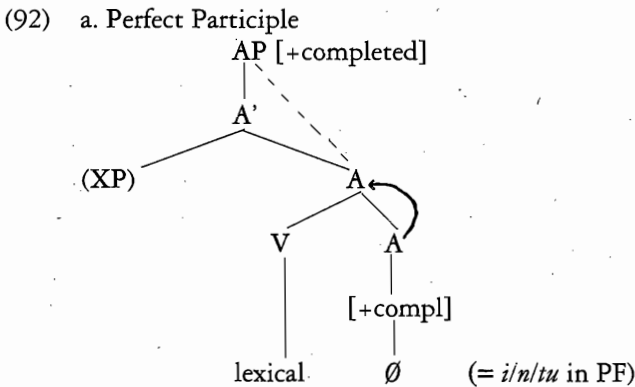

(25) By categorial signature, Lieber means the different features associated with the syntactic categories, such as [+Plural] [+/-I] (=first person) for nouns. The last statement in (90) simply means that features cannot percolate across heads of a different category. I assume here that aspect features on grammatical formatives are not part of the categorial signature *per se*; therefore they are free to percolate across a different category without violating (90).

(26) In Artiagoitia (1992a), this was derived from the *Aspect Condition*. See note 24.

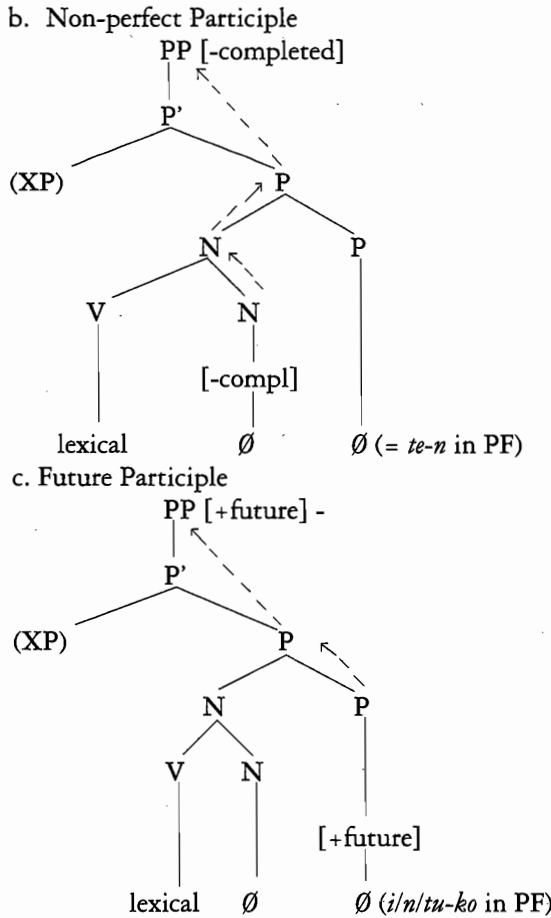

In view of (92a,b,c), the coordination facts described in section 4.2 now follow automatically. The different participles cannot be coordinated because they are dominated by different categorial nodes, AP and PP. And even though the non-perfect and the future participles are both dominated by a PP node (a necessary but not sufficient condition for coordination), they crucially differ in their aspectual feature; the impossibility of coordinating them can be attributed to this feature mismatch. No such explanation is available under Laka's Aspect Phrase hypothesis since no claim is made as to what specific features are ever associated with the different Aspect heads. The fact that locative grammatical PPs and the non-perfect participle can coordinate also follow from the analysis developed here: the feature [-completed] on (N and) DET is shared by spec(D) by spec-head agreement as in Chomsky (1986b). As demonstrated in Grimshaw (1991), a syntactic feature on DP (e.g. [+wh]) can be passed on to a PP in which the DP is embedded (as it is the case in pied-piping). Therefore, analyzing aspectual heads as grammatical formatives of category A, N, and P solves the deficiencies of the AspP hypothesis. The analysis put



forward in this section for Basque participles is based on the independently justified theoretical tools utilized throughout this article and elsewhere: Emonds' *Minimal Structure Principle*, reduction of syntactic subcategorization to selection of heads, *Empty Head Transparency*, and late insertion of grammatical formatives. It allows for a more restrictive view of the syntactic representation of "aspect-related" maximal phrases with various affixal heads than is widely assumed: no hypergeneration of XPs occurs with the subsequent subadjacency-related problems, no reduplication of morphological and syntactic selections is needed, and finally the postulation of a functional category Aspect is rendered unnecessary. Moreover, it proves that projecting the occurrence of *te* and the perfect morpheme as aspect markers reduces to, and is predictable from the lexical representations proposed in chapters two and three, thus avoiding the need to postulate that the same morphemes belong to different categories. The Aspect Phrase hypothesis is forced to duplicate the categorial status for *te* and the perfect morpheme (e.g. *te* is of category N, *te* is of category INFL, *te* is of category Asp) without capturing what is common to all the occurrences of the morpheme.

The picture emerging from chapters two and three and the analysis developed in this chapter is one where parametric variation across languages depends heavily on the lexical properties of grammatical formatives; as just seen, these don't necessarily correlate with the notion *functional* category. The morphemes *te*, *il/n/tu* and *ko*, the alleged "aspect" heads in Laka's analysis, are actually morphemes of the lexical categories Noun, Adjective and Postposition, lexically specified as having aspectual features.

## Glossary

|      |                    |      |                           |
|------|--------------------|------|---------------------------|
| A    | absolutive         | E    | ergative                  |
| abl  | ablative           | inst | instrumental              |
| adl  | adlative           | loc  | locative                  |
| aff  | affirmative marker | mot  | motative                  |
| aux  | auxiliary          | neg  | negation, negative marker |
| ben  | benefactive        | OP   | null operator             |
| com  | comitative         | part | partitive                 |
| comp | complementizer     | pl   | plural                    |
| des  | destinative        | prt  | particle                  |
| D    | dative             | sing | singular                  |

## List of references

- Abney, S., 1987, *The English Noun Phrase in its Sentential Aspect*. MIT PhD dissertation.
- Altube, S., 1929, *Erderismos*. Euskaltzaindia: Bilbao.
- Aoun, J. et al., 1987, "Two types of locality". *LI* 18. 537-577.
- Artiagoitia, X., 1991, "Aspects of tenseless relative clauses in Basque". *ASJU* xxv-3. 697-712.
- , 1991b, "The Structure of verbal projections in Basque". University of Washington Ms.
- , 1992a, *Verbal Projections in Basque and Minimal Structure*. University of Washington PhD dissertation.
- , 1992b, "Why Basque doesn't relativize everything". In J. Lakarra & J. Ortiz de Urbina (eds.), *Syntactic theory and Basque syntax*, Supplements of *ASJU* 27: Donostia. 11-35.
- Awberry, G. M., 1976, *The Syntax of Welsh. A transformational study of the passive*. Cambridge University Press: Cambridge.
- Baker, M., 1988, *Incorporation: A theory of grammatical function changing*. University of Chicago Press: Chicago.
- Baltin, M., 1989, "Heads and projections". In *Alternative conceptions of phrase structure*. M.R. Baltin and A.S. Koch eds. University of Chicago: Chicago. 1-16.
- Bartistella, E., 1983, "A subyacency puzzle". *LI* 14. 698-704
- Bollenbacher, J., 1977, "The Basque Passive". *Anglo-American Contributions to Basque Studies: Essays in Honor of Jon Bilbao*. Desert Research Institute Publications on the Social Sciences: Reno. 181-192.
- Borer, H., 1990, "V + *ing*: It walks like an adjective, it talks like an adjective". *LI* 21. 95-102.
- Bouda, K., 1973, "Berichtigungen zu einer Abhandlung ber baskische Syntax". *FLV* V. 21-36.
- Brekke, M., 1988, "The experiencer constraint". *LI* 19. 169-180.
- Bresnan, J., 1982, "The passive in lexical theory". In J. Bresnan ed. *The mental representation of grammatical relations*. MIT Press: Cambridge MA.
- Burton, S. and J. Grimshaw, 1992, "Coordination and VP-Internal Subjects". *LI* 23. 305-312.
- Burzio, L., 1986, *Italian syntax*. Reidel: Dordrecht.
- Chen, L. & Demirdash, H. 1991, "External arguments in Basque". In A. Halpen, *Proceedings of the Ninth WCCFL*. 125-139.
- Chomsky, N., 1965, *Aspects of the theory of syntax*. MIT Press: Cambridge MA.

- , 1970, "Remarks on nominalization". In Jacobos and Rosenbaum (eds.), *English transformational grammar*. 184-221.
- , 1977, "On Wh-movement". In P. Culicover, T. Wasow, and A. Akmajian (eds.) *Formal syntax*. Academic Press: New York. 71-132.
- , 1981, *Lectures on government and binding*. Foris: Dordrecht.
- , 1986a, *Knowledge of language*. Praeger: New York.
- , 1986b, *Barriers*. MIT Press: Cambridge, MA.
- , 1991, "Some notes on economy of derivation and representation". In R. Freidin ed. *Principles and parameters in comparative grammar*. MIT Press: Cambridge MA. 417-454.
- , 1992, "A minimalist program for linguistic theory". *MIT Occasional Papers in Linguistics* 1.
- , 1994, "Bare phrase structure". *MIT Occasional Papers in Linguistics* 5.
- Cinque, G., 1990, "Ergative adjectives and the lexicalist hypothesis". *NLLT* 8. 1-40.
- Comrie, B., 1976, *Aspect*. Cambridge University Press: Cambridge UK.
- Contreras, H., 1989, "On Spanish empty N and N\*". In *Studies in Romance Linguistics*, C. Kirschner & J. DeCesaris eds. John Benjamins: Amsterdam. 83-95.
- Costa, R., 1972, "A study of the SQA, NA, Y and Q nominalizing suffixes in Quechua". *Papers in Andean Linguistics* 1. 29-78.
- Diesing, M., 1990, "Verb movement and the subject position in Yiddish". *NLLT* 8. 41-80.
- Di Sciullo, A.M. & E. Williams, 1987, *On the definition of word*. MIT press: Cambridge MA.
- Eguzkitza, A., 1981, "On the so-called passive in Basque". *FLV* 37. 233-253.
- , 1986, *Topics in the syntax of Basque and Romance*. UCLA PhD dissertation. Distributed by IULC.
- , 1992, "The grammar of adnominals in Basque". In J. Ortiz de Urbina and J.I. Hualde (eds.), *Generative studies in Basque linguistics*, John Benjamins: Amsterdam. 163-187.
- Elordieta, G., 1990, "The nature of subjects in Basque tenseless clauses with an extension to Spanish". USC Ms.
- Emonds, J., 1976, *A transformational approach to English syntax*. Academic Press: New York.
- , 1978, "The Verbal complex V'-V in French". *LI* 9, 151-175.
- , 1980, "Word order in generative grammar". *Journal of Linguistic Research* 1. 33-54.
- , 1985, *A unified theory of syntactic categories*. Foris: Dordrecht.
- , 1989, "The Passive and past participle". University of Washington Ms.
- , 1990, "The autonomy of the (syntactic) lexicon and syntax: insertion conditions for Derivational and inflectional morphemes". In *Interdisciplinary approaches to language. Essays in Honor of S.-Y. Kuroda*, C. Georgopoulos and R. Ishihara eds. Kluwer Academic Publishers: Dordrecht.
- , 1991, "Subcategorization and syntax-based theta-role assignment". *NLLT* 9. 369-430.
- , 1992, "The autonomy of the (syntactic) lexicon and syntax: insertion conditions for derivational and inflectional morphemes". In *Syntactic theory and Basque syntax*. J. Laka-rra, and J. Ortiz de Urbina eds.
- Esen, I., 1973, *Sentential complementation in Turkish*. University of Washington MA thesis.
- Euskaltzaindia, 1985, *Euskal Gramatika. Lehen Urratsak-I*. Euskaltzaindia: Irunea.
- , 1987, *Euskal Gramatika. Lehen Urratsak-II*. Euskaltzaindia: Bilbao.
- Fabb, N., 1983, *Syntactic affixation*. MIT PhD dissertation.
- Fukui, N. & Speas, M., 1986, "Specifiers and projections". *MIT Working Papers in Linguistics* 8. 128-172.
- George, L. & Kornfilt, J., 1981, "Finiteness and boundedness in Turkish". in *Binding and Filtering* F. Heny ed. MIT Press: Cambridge MA.

- Giorgi, A and Longobardi, G., 1990, *The syntax of noun phrases*. Cambridge University Press: Cambridge UK.
- Grimshaw, J., 1990, *Argument structure*. MIT Press: Cambridge MA.
- , 1991, *Extended projections*. Brandeis University Ms.
- Goenaga, P., 1980, *Gramatika bideetan*. Erein: Donostia. 2nd ed.
- , 1984, *Euskal sintaxia: konplementazioa eta nominalizazioa*. University of the Basque Country PhD dissertation.
- Hornstein, N., 1990, *As time goes by*. MIT Press: Cambridge, MA.
- Horvath, J., 1986, *Focus in the theory of grammar and the syntax of Hungarian*. Foris: Dordrecht.
- Hualde, J.I., 1988, "Case assignment in Basque". *ASJU* XXII-1. 313-332.
- Huang, J., 1983, "A note on binding theory". *LI* 14. 554-561.
- , 1984, "On the distribution and reference of empty pronouns". *LI* 15. 531-574.
- , 1989, "Pro drop in Chinese: A generalized control theory". In *The null subject parameter* O.Jaeggli and K.Safir eds. Kluwer: Dordrecht.
- Irigoyen, I., 1985, *En torno a la evolución y desarrollo del sistema verbal vasco*. Irigoyen: Bilbao.
- Jackendoff, R., 1977, *X-Bar syntax: a study of phrase structure*. MIT Press: Cambridge MA.
- Johnson, K., 1988, "Clausal gerunds, the ECP, and Government". *LI* 19. 583-609.
- Kaisse, E., 1985, *Connected speech*. Academic Press: New York.
- Koopman, H., 1984, *The syntax of verbs*. Foris: Dordrecht.
- & Sportiche, D., 1991, "The position of subjects". *Lingua* 85. 211-258.
- Koster, J., 1978, "Why subject sentences don't exist". In *Recent transformational studies in European languages*. MIT Press: Cambridge MA.
- Klima, E., 1964, "Negation in English". In J. Fodor and J.Katz (eds). *The structure of language*. Prentice Hall. 246-323.
- Kuroda, S.Y., 1988, "Whether we agree or not". In W. Poser ed. *Papers from the second International Workshop on Japanese Syntax*. CSLI, Stanford University. 103-143.
- Lafitte, P., 1962, *Grammaire Basque*. [Reprinted 1979. Elkar: Baiona].
- Lafon, R., 1943, *Le système du verbe basque au XVIe siècle*. [Reprinted 1980. Elkar: Donostia].
- Laka, I., 1985, "Azpikotasunaren baldintzaz: muga adabegiak euskaraz". In P. Goenaga ed. *Euskal sintaxiaren zenbait arazo*. UPV-EHU: Bilbao. 97-127.
- , 1988, "Configurational heads in inflectional morphology: the structure of the inflected forms in Basque". *ASJU* XXII-2. 343-366.
- , 1990, *On the nature of functional categories and projections*. MIT PhD dissertation.
- , 1993, "Unergatives that assign ergative, unaccusatives that assign accusative". In J.D. Bobaljik and C. Phillips (eds.), *Papers on case and agreement I*. MIT Working Papers in Linguistics, v. 18. 149-172.
- & Uriagereka, J., 1987, "Barriers for Basque and viceversa". *Proceedings of NELS*.
- Levin, B., 1983, *On the nature of ergativity*. MIT PhD dissertation.
- & M. Rappaport, 1986, "The formation of adjectival passives". *LI* 17. 623-661.
- Lieber, R., 1980, *On the organization of the lexicon*. MIT PhD dissertation.
- , 1992, *Deconstructing morphology*. University of Chicago Press: Chicago.
- Lobeck, A., 1986, *Syntactic constraints on VP ellipsis*. University of Washington PhD dissertation.
- , 1991, "Phrase structure of ellipsis". In *Syntax and semantics*. Volume 23. S. Rothstein ed. 81-102.
- Malln, E., 1989, "Extraction from Spanish NP". Cornell University Ms.
- McNally, L., 1992, "VP coordination and the VP Internal Subject". *LI* 23. 336-341.
- Mitxelena, K., 1981, "Galdegaia eta mintzagaia euskaraz". In *Euskal linguistika eta literatura: Bide berriak*. Deustuko Unibertsitateko Argitarazioak: Bilbao. 57-81.

- Muysken, P. and Lefebvre, A., 1988, *Mixed Categories*. Reidel: Dordrecht.
- , 1989, "Predication chains: case and argument status in Quechua and Turkish". *LI* 20. 627-646.
- Olarrea, A., 1991, "Lexical subjects of infinitives in Spanish". University of Washington Ms.
- Ortiz de Urbina, J., 1989, *Parameters in the grammar of Basque*. Foris: Dordrecht.
- , 1989b, "Dislocaciones verbales en estructuras de polaridad". *ASJU* XXIII-2. 393-410.
- , 1992, "Interrogative discharge and the Wh-criterion in Basque". In J. Lakarra & J. Ortiz de Urbina (eds.), *Syntactic theory and Basque syntax*, Supplements of *ASJU* 27: Donostia. 295-308.
- , 1993, "Feature percolation and clausal pied-piping". In J. Ortiz de Urbina and J.I. Hualde (eds.), *Generative studies in Basque linguistics*, John Benjamins: Amsterdam. 189-219.
- , 1994, "Checking domains in Basque". *Lingua*.
- & J.I. Hualde., 1987, "Restructuring with ARI". *ASJU* XXI-2. 425-452.
- & M. Uribe-erxebarria, 1991. "Participial predication in Basque". In J. Lakarra ed., *Memoriae L. Mitxelena Magistri Sacrum*. Supplements of *ASJU*: Donostia. 993-1012.
- Ouhalla, J., 1991, *Functional categories and parametric variation*. Croom Helm: London.
- Oyarçabal, B., 1992, "Structural and inherent case marking: ergaccusativity in Basque". In J. Lakarra & J. Ortiz de Urbina (eds.), *Syntactic theory and Basque syntax*, Supplements of *ASJU* 27: Donostia. 309-342.
- Pesetsky, D., 1987, "Wh-in-situ: movement and unselective binding. In *The representation of (in)definiteness*. E. Reuland and A. Ter Meulen eds. MIT Press: Cambridge MA.
- Pollock, J-Y., 1989a, "Verb movement, universal grammar, and the structure of IP". *LI* 20. 365-424.
- , 1989b, "Opacity, genitive subjects...". *Probus* 1.2. 151-162.
- Plann, S., 1981, "The two *el* + infinitive constructions in Spanish". *Linguistic Analysis* 7. 203-240.
- Raposo, E., 1987, "Case theory and Infl-to-Comp: The inflected infinitive in European Portuguese". *LI* 18. 85-109.
- Rebuschi, G., 1983, *Structure de l'énoncé en basque*. Laboratoire de Linguistique Formelle, ERA 642: Paris.
- , 1984, "On the non-configurationality of Basque and some related phenomena". [Published in, *ASJU* XXIV-2, 1990, 351-384.]
- , 1986, "Théorie du liage, diachronie et énonciation: Sur les anaphores possessives du Basque". *ASJU* XX-2. 325-342.
- , 1989, "Is there a VP in Basque?". In L. Marcz and P. Muysken eds. *Configurationality. The typology of asymmetries*. Foris: Dordrecht. 85-116.
- Reuland, E., 1983, "Governing ING". *LI* 14. 101-134.
- Rijk, R. de, 1969, "Is Basque an SOV language?". *FLV* I. 319-351.
- , 1972a, *Studies in Basque syntax: relative clauses*. MIT PhD dissertation.
- , 1972b, "Partitive assignment in Basque". *ASJU* VI. 130-173.
- , 1978, "Topic fronting, focus positioning and the nature of the Verb Phrase in Basque". In F. Jansen ed. *Studies on fronting*. The Peter de Ridder Press: Lisse. 81-112.
- Rizzi, L., 1982, *Issues in Italian syntax*. Foris: Dordrecht.
- , *Relativized minimality*. MIT Press: Cambridge MA.
- , 1991, "Residual verb second and Wh-criterion". Universit de Genève Ms.
- Ross, H., 1969, "Auxiliaries as main verbs". In W. Todd ed. *Studies in Philosophical linguistics*. Great Expectations Press: Evanston, ILL.

- Sadler, L., 1988, *Welsh syntax: a GB approach*. Croom Helm: London.
- Salaburu, P., 1985, "La teora del ligamiento en la lengua vasca". *ASJU* XX-2. 359-412.
- Salvi, G., 1982, "L'infinito con l'articolo e la struttura del SN". *Rivista de Grammatica Generativa* 1. 197-225.
- Sebuktin, H., 1971, *Turkish-English contrastive analysis*. Mouton: The Hague.
- Selkirk, L., 1982, *The syntax of words*. MIT Press: Cambridge MA.
- Speas, M., 1990, *Phrase structure in natural language*. Kluwer: Dordrecht.
- Sproat, R., 1985, "Welsh syntax and VSO structure". *NLLT* 3. 173-216.
- Stowell, T., 1981, *Origins of phrase structure*. MIT PhD dissertation.
- , 1982, "The tense of infinitives". *LI* 13. 561-570.
- , 1989, "Subjects, specifiers and x-Bar Theory". In *Alternative conceptions of phrase structure*. M.R. Baltin and A.S. Koch eds. University of Chicago: Chicago. 232-262.
- Suzuki, T., 1988, *The structure of English gerunds*. University of Washington PhD dissertation.
- Travis, L., 1989, "Parameters of phrase structure". In *Alternative conceptions of phrase structure*. M.R. Baltin and A.S. Koch eds. University of Chicago: Chicago. 263-279.
- , 1991, "Parameters of phrase structure and verb-second phenomena". In R. Freidin ed. *Principles and parameters in comparative grammar*. MIT Press: Cambridge MA. 339-364.
- Torrego, E., 1987, "DPs". Boston University Ms.
- Uriagereka, J., 1992, "The syntax of movement in Basque". In *Syntactic theory and Basque syntax*, J. Lakarra and J. Ortiz de Urbina eds. *ASJU* monographs: Donostia.
- Walinska de Hackbeil, H., 1986, *The roots of phrase structure. the syntactic base of English morphology*. University of Washington PhD dissertation.
- Yoon, J.H. & Bonet-Farran, N., 1988, "The ambivalent nature of spanish infinitives". In Wanner, Dieter and Kibbee, Douglas. *New analyses in Romance linguistics*. Benjamins: Amsterdam.
- Watkins, T.A., 1960, "CC y/yn berfenwol". *Bulletin of the Board of Celtic Studies*. 18, pt 4.
- Wasow, T., 1977, "Transformations and the lexicon". In P. Culicover, T. Wasow, and A. Akmajian eds. *Formal syntax*. Academic Press: New York.
- Wilbur, T., 1979, *Prolegomena to a grammar of Basque*. John Benjamins: Amsterdam.
- Williams, E., 1977, "Discourse and logical Form". *LI* 8. 101-139.
- , 1978, "Across-the-board rule application". *LI* 9. 31-43.
- , 1981, "Argument structure and morphology". *The Linguistic Review* 1. 81-114.
- , 1981b, "On the notions 'lexically related' and 'head of a word'". *LI* 12. 245-274.
- Willis, P., 1988, "Is the Welsh verbal noun a verb or a noun?". *Word* 39. 201-224.
- Zagona, K., 1982, *Government and proper government of verbal projections*. University of Washington PhD dissertation.
- , 1988a, *Verb phrase syntax. A parametric study of English and Spanish*. Kluwer: Dordrecht.
- , 1988b, "Government and proper government of antecedentless VPs". *NLLT* 6. 95-128.
- , 1990, "Perfective *Haber* and the theory of tenses". In *Current studies in Spanish Linguistics*, H. Campos and F. Martnez Gil eds. Georgetown University Press.
- , 1991, "Tense binding and the construal of present tense". In C. Laeufer and T. Morgan eds. *Proceedings of the linguistic symposium on Romance Languages XIX*. J. Benjamins: Amsterdam.
- Zubizarreta, M.L., 1987, *Levels of representation in the lexicon and in the syntax*. Foris: Dordrecht.

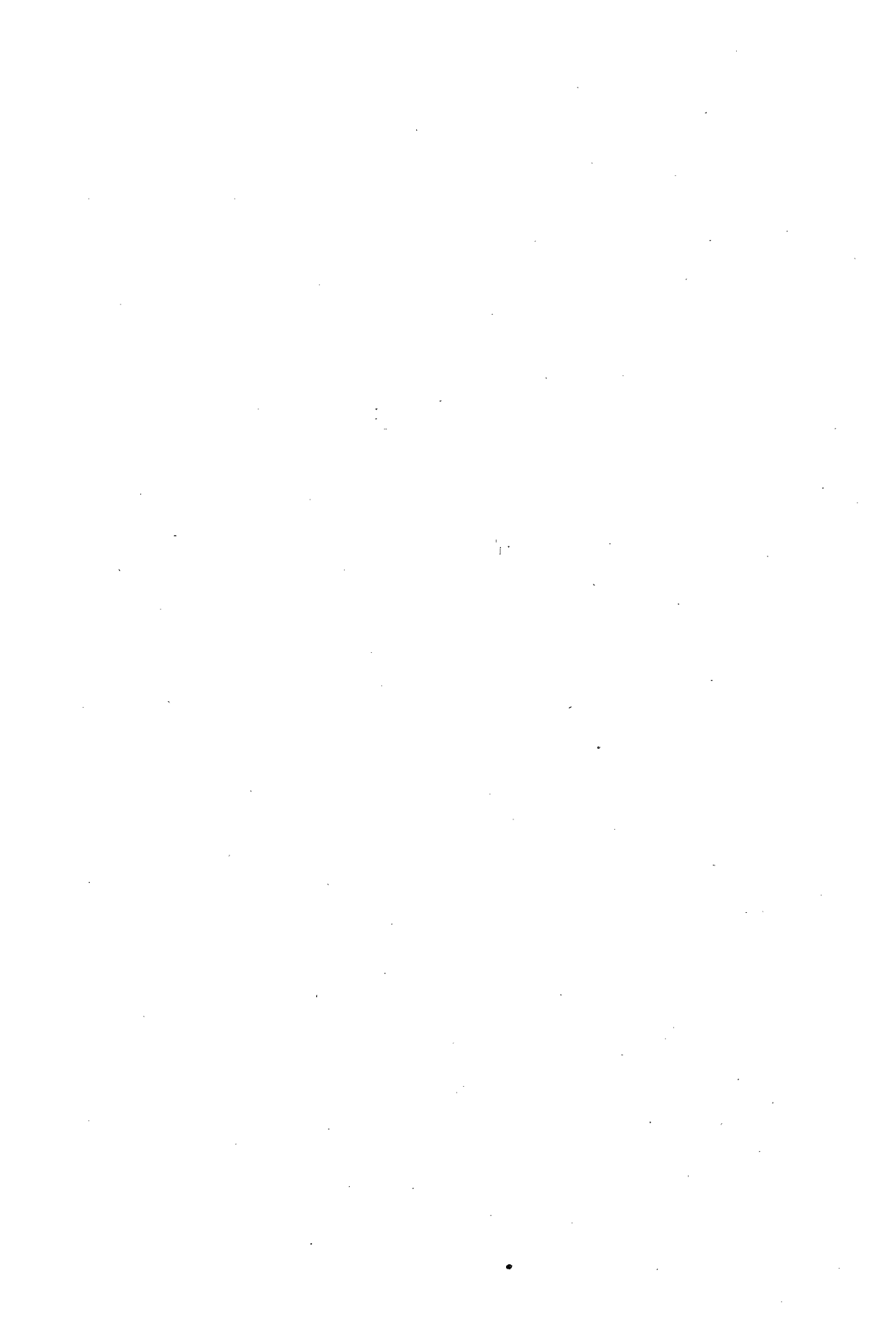









- XXII. LASZLÓ K. MARÁCZ, *Asymmetries in Hungarian*, 1991. 2.500 pta. (2.000).
- XXIII. PETER BAKKER, GIDOR BILBAO, NICOLAAS G. H. DEEN, JOSÉ I. HUALDE, *Basque pidgins in Iceland and Canada*, 1991. 1.500 pta. (1.200).
- XXIV. MANUEL AGUD - † ANTONIO TOVAR, *Diccionario etimológico vasco*, III. *Beule-Egileor, Babarraso-Bazur*, 1991. 1.000 pta. (800).
- XXV. JOSÉ M<sup>a</sup> SÁNCHEZ CARRIÓN, *Un futuro para nuestro pasado*, 1991. 2.500 pta. (2.000).
- XXVI. MANUEL AGUD - † ANTONIO TOVAR, *Diccionario etimológico vasco*, IV. *Egiluma-Galan-ga*, 1991. 1.000 pta. (800).
- XXVII. JOSEBA A. LAKARRA - JON ORTIZ DE URBINA (eds.), *Syntactic theory and Basque syntax*, 1992. 3.000 pta. (2.500).
- XXVIII. RICARDO GÓMEZ - JOSEBA A. LAKARRA (eds.), *Euskal dialektologiako kongresua (Donostia, 1991-ko irailaren 2-6)*, 1994. 3.500 pta. (3.000).
- XXIX. JOSÉ IGNACIO HUALDE - XABIER BILBAO, *A phonological study of the Basque dialect of Getxo*, 1992. 1.000 pta. (800).
- XXX. MANUEL AGUD - † ANTONIO TOVAR, *Diccionario etimológico vasco*, V. *Galani-Iloza*, 1992. 1.000 pta. (800).
- XXXI. KARLOS OTEGI LAKUNTZA, *Lizardi: lectura semiótica de Biotz-begietan*, 1993. 3.000 pta. (2.500).
- XXXII. AURELIA ARKOTXA, *Imaginaire et poésie dans Maldan behera de Gabriel Aresti (1933-1975)*, 1993, 1.500 pta. (1.200).
- XXXIII. MANUEL AGUD - † ANTONIO TOVAR, *Diccionario etimológico vasco*, VI. *Ilpiztu-Korotz*, 1993. 1.000 pta. (800).
- XXXIV. JOSÉ IGNACIO HUALDE - GORKA ELORDIETA - ARANTZAZU ELORDIETA, *The Basque dialect of Lekeitio*, 1994. 3.000 pta. (2.500).
- XXXV. GEORGES REBUSCHI, *Essais de linguistique basque*, 1994. 3.000 pta. (2.500).
- XXXVI. XABIER ARTIAGOITIA, *Verbal projections in Basque and minimal structure*, 1994. 2.000 pta. (1.600).
- XXXVII. MANUEL AGUD - † ANTONIO TOVAR, *Diccionario etimológico vasco*, VII. *Korpa Orloi*, 1994. 1.000 pta. (800).

Seminario de Filología Vasca  
 "Julio de Urquijo"  
 1.792 Apartadua  
 20080 Donostia.

