

The Syntax of Movement in Basque

JUAN URIAGEREKA
(UNIVERSITY OF MARYLAND)

1. The Puzzle¹

Traditional Basque grammars have noted the following peculiar fact about question formation in this language:² The *Wh*-phrase must be left-adjacent to the verb—we will make this more precise as we go along. This yields structures of the form *Wh-S V O*, *O Wh-S V*, *Wh-O V S*, *S Wh-O V*, and so on, in a language which underlyingly is SOV.³ Crucially, the sequence *Wh V* does not appear to be broken. For this the arguments can be displaced in different directions, left or right. They can even be dropped completely (the language is pro-drop in all major arguments, subject, object, and indirect object, since it shows verbal agreement with all three). What is not found is instances where, say, a *Wh-O S V* order arises:

- (1) *Zer zuk edango duzu
what you drink-will III-aux-II

This is much easier to describe than to explain. To see this, consider the type of account provided by Eguzkitza (1986). Following similar analyses for a comparable paradigm in Hungarian,⁴ Eguzkitza proposes that *Wh*-questions in Basque move to a special Focus position, left-adjacent to the verb. Indeed, focalization, like question formation, is subject to adjacency restrictions of the sort just pointed out. Thus, for instance, (2) is not a well-formed answer to the question raised in a grammatical version of (1) above:

(1) I am grateful to A. Barss, N. Chomsky, A. Eguzkitza, P. Goenaga, K. Hale, K. Johnson, Ch. Jones, R. Kayne, T. Kroch, H. Lasnik, J. Ormazabal, J. Ortiz de Urbina, B. Oyharçabal, G. Rebuschi, P. Salaburu, I. Sarasola, E. Torrego, M. Uribe-Extebarria, and very especially I. Laka (who is more than anything a co-author) for data, insights, discussion, scepticism, etc. Thanks also to J. Lakarra for his constant interest in getting this article in print for almost half a decade, in spite of my procrastination. As usual, I claim errors and misinterpretations.

(2) The first to study the phenomenon systematically is Altube (1929). In recent years, several accounts have been proposed, including Eguzkitza (1986), Laka and Uriagereka (1987), Uriagereka (1987), and Ortiz de Urbina (1989).

(3) This is obvious from tests on intonation patterns, and semantic considerations having to do with emphasis of marked orders, presumably arising via scrambling, dislocation, topicalization and so forth. Several syntactic arguments have been provided for the unmarked order by many, following explicitly or implicitly De Rijk (1978), Levin (1984), Salaburu (1986), Uriagereka (1987), Ortiz de Urbina (1989).

(4) See Horvath (1981), Kiss (1987).

- (2) *ARDOA zuk edango duzu
WINE you drink-will III-aux-II

First, note that this entails proposing a parameter to divide the class of natural languages between those which are like Basque (and possibly Hungarian, etc.) and those which are, say, like English. In general, we want to avoid this move whenever possible, short of reproducing the problems that systems of rules raised in the sixties. More importantly, we have to ask how it would be possible for the Basque child to set the relevant parameter. Of course, no negative description of the sort mentioned above is available to infants. Further, the actual data are compatible with an analysis that would tell the child that the language s/he is learning is, in the relevant respects, like English. Thus, as pointed out by Uriagereka (1987) the (a) examples below can be analyzed roughly as in (b), simply by using devices of Universal Grammar:

- (3) a. *Wh-S V O*
b. [_{CP} Wh-S_i [_{IP} t_i [[_{pro}_j V] O_j]]]
- (4) a. *O Wh-S V*
b. [_{TOP} O_j [_{CP} Wh-S_i [_{IP} t_i [_{pro}_j V]]]]
- (5) a. *Wh-O V S*
b. [_{CP} Wh-O_j [_{IP} pro_i [[_{VP} t_j V] S_i]]]
- (6) a. *S Wh-O V*
b. [_{TOP} S_i [_{CP} Wh-O_j [_{IP} pro_i [t_j V]]]]

This entails that, if Eguzkitza's position is to be maintained, we cannot allow UG to be as we usually assume. In other words, Basque must be the *unmarked* option, with standard Wh-movement being learned by positive data of the sort impossible in Basque (e.g., a grammatical *Wh-O S V*). Notice also that several languages in the world allow Wh-in situ. But this option will not do for Basque either, since in an SOV language that should most definitely allow, at least, *Wh-S O V* structures.⁵ In a nutshell, all the languages that we have investigated thus far are marked, and Basque (and Hungarian, etc.) provide the truly unmarked Wh-option. This seems unlikely.

Researchers aware of this fact try to link the setting of the parameter in question to an alleged non-configurationality of the language at issue.⁶ Eguzkitza does not try this for Basque for good reasons: there are innumerable tests that argue that Basque is as configurational as a language can be. Some of the tests are standard Binding, Crossover, Incorporation, Control effects.⁷ Others are more current: Laka (1988) shows that there is no simple way of explaining the morphology of the Basque auxiliary unless configurationality is assumed; Cheng and Demirdash (forthcoming) pro-

(5) In fact, these do appear in traditional Basque texts, as will be discussed below, but are ungrammatical for some modern speakers.

(6) This is clear, for instance, in the Hungarian literature mentioned above.

(7) All the references mentioned thus far either present explicit arguments for configurationality or analyses that presuppose it. Occasional evidence to the effect that Binding of anaphors in "subject" position is possible from "object" position in Western dialects is irrelevant, in light of the recent literature on binding from scrambled sites, including Weibelhuth (1988), Mahajan (1990).

vide a clausal analysis coherent with Laka's auxiliary which is crucially configurational, and directly mapped from the Thematic Hierarchy. Also, just as before, the hypothesis of non-configurationality (even if the facts did not deny it) is just impossible for the child to set, for a non-configurational analysis is entirely compatible with a configurational one which makes generous use of *pro*, in a language with rich agreement all over, a point also raised in Uriagereka (1987). Thus we would have to claim that the null hypothesis is non-configurationality. But this yields a worse result: the child learning, say, English, would hypothesize that the language *s/he* is learning is non-configurational, and no data would correct this wrong assumption. Given the freedom of word order of non-configurationality, it must be the *marked* option. This suffices for the child not to have to take it in the case that concerns us, provided that an unmarked alternative is available. To link then the Wh-facts in question to configurationality would have devastating effects, for in fact we should either not have these facts at all, or else have idiosyncratic variation among speakers (assuming some children may choose randomly the marked option).

Within current assumptions about phrase structure, movement, and so on, the analysis in question does not stand a chance, either, in as much as it entails lowering of phrases to V adjunction. That should violate at least the ECP and the Structure Preserving Hypothesis, not to go into further technical details.⁸ Also, *some kind of scopal movement* is going to have to take place prior to interpretation, short of failing to create variables for the relevant Logical Structures.⁹ Presumably, in instances of *wonder*-type verbs, selecting a Wh-phrase, this scoping would have to be to the spec of CP—unless we want to invoke a further parameter here. Then the obvious question is: why does Basque have to take the cumbersome route of lowering Wh-phrases down to the mysterious position, if in any case these elements are going to have to be moved to the regular spec of CP? Two answers only come to mind: either there is something deeply wrong with all our analyses of Wh-movement in the last twenty years, or else there is something deeply wrong with the proposal under scrutiny. At least for concreteness, here we shall entertain seriously only the second possibility.

Another analysis addresses all of the theoretical problems above, and offers an intriguing alternative that is worth exploring seriously. This is Ortiz de Urbina (1989), which describes the phenomenon in question in terms (mostly) of well-attested properties of UG. Ortiz de Urbina equates Basque to Spanish, as in Torrego's (1984) analysis of Wh-questions. For Torrego, Wh-questions in Spanish entail movement of V to the pre-sentential periphery, for reasons she does not discuss.¹⁰ This of course results in the Wh-phrase in spec CP being adjacent to the displaced V, yielding the

(8) See Chomsky (1986).

(9) This fact is indeed noted by Eguzkitza, and the solution that follows is explicitly proposed.

(10) There are at least two respects in which Torrego's specific analysis differs from Ortiz de Urbina's. First, for Torrego verb-movement is adjunction to IP, whereas for Ortiz de Urbina, it is movement to C. However, it is easy to recast Torrego's analysis in Ortiz de Urbina's terms—arguably a more principled approach. (This, of course, would entail reviewing Torrego's arguments for not having movement to C.) More complex is the fact that in Spanish, when an auxiliary is present, just the auxiliary needs to move (although the whole verb sequence, apparently, can). In Basque, in contrast, the whole verb sequence appears to be in a displaced position. Since it is not clear what motivates either process, this descriptive fact is hard to analyze coherently. I return to this below.

now familiar *Wh-V* sequence that concerns us here. That is, crucially, in a language that is head-first. A problem for Ortiz de Urbina's analysis is that Basque is head-last. This means that movement of *V* to *C*, which he explicitly proposes in fact should *maximally separate* *Wh-* from *V*. Ortiz de Urbina is well aware of this, and for it he stipulates that, in spite of the otherwise clear regularity in Basque heads, *Comp* is first. The evidence he adduces for this is scarce, and rather questionable.¹¹ Chief among his difficulties, though, is the fact that overt Basque Comps *are last*:

- (7) Zer [edango duela] esan du
 what drink III-will-III-that said III-have-III
 'what has he said that he will drink'

This is an instance of a well-known observation: *Wh*-movement is always to the left, even in head-last languages where a traditional analysis would expect it to be to the right.¹²

Ortiz de Urbina claims that the element *la*, and similar complementizers are mere features in *Infl*, which is indeed last. Somewhat mysteriously, these features surface in the right periphery of *Infl*.¹³ The child must override the obvious option of analyzing this peripheral element (which otherwise has all the properties of *Comp*) as a true *Comp*, and furthermore must *not* come up with the obvious generalization that, since Basque is uniformly head-last, it is so in this instance as well.¹⁴ The only evidence to learn said structures is the one in point. But as we have shown, said ev-

(11) For instance, he notes that certain "complementizers" may appear first, e.g., *nola* 'how'. This is not surprising: said elements are not obviously in the head of *CP*. Thus, 'how' is a typical marker in many languages of a complement clause with a *de dicto* interpretation:

(i) A student of Pitagoras demonstrated how the square root of two is not a rational number
 Typically, complement clauses of this sort are islands:

(ii) what did he demonstrate that/*how the square root of two is
 This follows if said elements are in the spec of *CP*, not in the head.

(12) Hence the proposal of having *Wh*-phrases move to the spec of *Comp*, not to *Comp* itself. See Koopman (1984) for discussion.

(13) Notice that this fact is directly explained in Baker's (1988) terms if *Comp* is last, even assuming that the element *la* is part of the morphology of the auxiliary —as it probably is. That is, for Baker *Infl* will be able to incorporate to *Comp*, leaving the latter in its periphery. This is the sort of analysis that Laka (1988) proposes for the auxiliary —and is indeed the tacit or explicit assumption for virtually everyone else in the field. Another possibility is that *Comp* lowers, in the way affix-hopping takes place, presumably, in English (see Chomsky 1989).

(14) Laka (1990), in the spirit of Pollock (1988), claims that negative elements are heads in Basque, and argues that they are furthermore head-first. It is questionable, however, whether Pollock is right in that phrases headed by *Neg* exist. Since the matter is under current scrutiny and remains highly controversial, I will not address it for now. I do believe, personally, that Negative operators are syncategorematic, and apply to any predicate (regardless of syntactic category) as modifiers. Heads are seldom, if ever, this free, having much more strict sub-categorization restrictions. For this and related discussion, see Hornstein, Rosen and Uriagereka (in progress). I should also point out that Basque is not the only known language which, being head-last uniformly, has negative and emphatic operators triggering a *V-2* effect (i.e., attracting the auxiliary to second position). For instance, some Uto-Aztecan dialects which are otherwise uniformly head-last nevertheless show sentence negation and modals regularly in second position. I suspect that a unified account should be possible without invoking the notion head (thereby breaking the otherwise clear regularity of the head parameter). What I have in mind is a semantic principle that demands of (certain) operators that they be first —with the intuitive import of "it is not the case that [sentence]". I will not pursue this here.

idence is perfectly compatible with an analysis that does not have Ortiz de Urbina's properties. Therefore his analysis would have to be the unmarked one. Again, it is hard to see how this can be the case: the prediction is that all languages should look like Basque (and perhaps Spanish), even in embedded clauses—which is clearly not true. Thus, for instance, the English child does not have the option of moving embedded verbs; the analysis with verb movement in those sites must then correspond to a marked option triggered by positive data—the paradox, then, follows.

Deeper than this paradox still is the question, again, of why Basque—or for that matter Spanish—takes peculiar routes. It should perhaps be emphasized that the structures in question are indeed more peculiar than Ortiz de Urbina (or Torrego in her article) imply. There is a vague sense in which these are equated with Verb-second phenomena. The comparison, however, is not accurate on three counts: (i) Verb-second happens only when some other process, typically Wh-movement or Topicalization, also happens, with few exceptions—in languages where verb fronting is obligatory in all declarative sentences; in contrast, what we see here is a rather *free* “verb movement”, which becomes necessary only when Wh-movement and similar processes happen. (ii) Verb-second is generally a root clause phenomenon—that is, verb movement in embedded clauses is not even an option;¹⁵ in contrast, the one in question is a “verb movement” that *can* happen in embedded clauses, again regardless of whether Wh-movement or topicalization is at issue. (iii) the “verb movement” under discussion is in fact *obligatory* in embedded questions and similar circumstances, which is rarely the case in typical Verb-second languages.¹⁶

In general, to show, even if convincingly, that a mystery that holds in a language, holds also in others, is not an explanation, and is subject to the twists and turns of new analyses of the supporting evidence. Thus, in Torrego and Uriagereka (in progress) we reanalyze the data in Torrego (1984) without making use of the Verb-movement hypothesis, by way of a generous use of *pro*, null operators, and related devices. The point is, once Torrego's analysis is recast in these terms, the weak motivation for Ortiz de Urbina's disappears. In particular, there is no reason any more why the verb should go leftwards, his main concern. In any case, one should emphasize Ortiz de Urbina's attempt as definitely the most serious ever within the grammar of Basque to provide a solution to this puzzle.

2. Extending the Data

There are at least three sets of data that escaped the consideration of traditional linguists, all of which contradict the generalization in point. Consider first (8), a kind of example observed by Mitxelena (1981), described by Laka (1985):

(15) With few exceptions. In the Germanic languages, for instance, embedded V-2 is possible in constructions of saying, and so on, when the complementizer is missing; but these constructions are presumably “root” in nature. Languages like Greek, on the other hand, are much freer, even in embedded clauses—like Spanish and Basque. Also, the phenomenon in point is rather free in relative clauses, which is another typical domain where V-2 is not apparent.

(16) All of this is not to imply, incidentally, that we have a good explanation of Verb-second; rather, the descriptive generalizations traditionally given for this phenomenon do not fit the ones in point.

- (8) zergatik zaldunak herensugea hil zuen
 why knight-the dragon-the kill III-has-III
 'Why did the knight kill the dragon'

Here we have an event adjunct not adjacent to the verb. Examples like these are hard to judge in modern dialects: they range from perfect for some speakers to marginal (or rhetorical) to others. In fact, Ortiz de Urbina does note that such exceptions exist, and compares them to similar exceptions in Spanish, noted by Torrego. Thus, a translation of (8) into Spanish is fine:¹⁷

- (8') por qué el caballero mató al dragón

Of course, lacking an explanation as to why the rule (assuming it exists) applies, it is hard to know why the exception applies.

A further wrinkle to the data above, first pointed out in Uriagereka (1987), is shown in (9):

- (9) a. zergatik P. esan du ardoa edango duela
 why P. say III-has-III wine drink-will III-aux-III-that
 'Why does P. say he will drink wine?'
 b. por qué Pedro dice que beberá vino
 why Pedro says that will-drink wine
 'Why does Pedro say he will drink wine?'

The sentences in (9) are possible only if *why* modifies the matrix, not the embedded clause in each instance. (In other words, these are questions about Pedro's reasons for saying such-and-such, not his reasons for drinking wine.) Now the presence of an intervening subject has a mysterious effect indeed, at least from the point of view of the traditional pattern and the analyses presented thus far: it does not block extraction of a matrix adjunct, but it blocks extraction of an embedded adjunct.¹⁸

Laka also notes that the presence of event adjuncts between the Wh-phrases and the verb does not seem to affect the initial generalization for many speakers:

- (10) a. nor honela etorri da
 who thus come is
 'Who has come this way?'
 b. zer adorazione-mota hemen kondenatzen da
 what adoration-kind here condemned is
 'What kind of adoration is condemned here?'
 (Leizarraga, 16th cent.)

The same hedges as above apply for modern speakers, with different speakers varying in their judgements. Again it is easy to see that this fact is not amenable to a description by either of the theories above.

(17) Uribe-Etxebarria (1990) discusses whether the presuppositions of each kind of example, with the subject intervening or not, vary in each instance. My view is that they do, but I am not convinced this affects the matter at issue.

(18) The relevant reading is possible if the matrix subject is not present.

Finally, consider (11):

- (11) a. nork ardoa edaten du
 who wine drink III-have-III
 'Who has drunk wine'
- b. nork mahaia bedeinkatuko du
 who table-the bless-fut III-aux-III
 'Who will bless the table?'
 (Mogel, 19th cent.)

(I purposely leave sentences like these, first discussed in Laka and Uriagereka (1987), without judgements.) It turns out that, at least for some speakers, (11) is far from terrible. What is more important, Ibon Sarasola (personal communication) has provided a good number of examples in the written texts of the relevant format: *Wb-S O V*. Said texts are part of the corpus of the Basque dictionary he is editing, thus belong mostly to older dialects, prior to the reunification of Basque carried on in the late sixties. I have no intention here of conducting a philological analysis of this, but simply will trust Sarasola's observation that the exception in question does not extend to the format *Wb-O S V*.¹⁹ Modern speakers do have varying judgements with respect to (8); again Sarasola notes this kind of example is more usual in modern Eastern dialects than in Western ones, where the construction is clearly stigmatized. Be that as it may, this seems like a piece of data that deserves a non-trivial explanation.

Notice, incidentally, that an incorporation analysis of the direct object in (11), of the sort proposed by Uriagereka (1987) for constructions as in (12a), is not immediately obvious across the board. Thus, whereas *lan egin* in (12a) has a compositional meaning roughly equivalent to "work", this is not the case in (12b), where *lana*, crucially, bears an article, thus is an argument of the verb:

- (12) a. nork lan egin du
 who work make III-have-III
 'Who has worked'
- b. nork lana egin du
 who work-the make III-have-III
 'Who has done the work'

(19) With the usual hedges; some examples of this sort do appear in the texts:

- (i) zer horrek esan nahi du
 what that-erg say want aux
 'what does that mean?'

(Thanks to Miriam Uribe-Etxebarria and Javier Ormazabal for bringing this instance to my attention.) This is a particularly tricky example, for it involves a modality which may be introducing —at least arguably— an embedded clause. If so, in rigor (i) may be an instance of long —distance movement, which as shall be seen below involves rather special mechanisms— see (26). At any rate, to falsify my claim something more than one counterexample has to be found: a whole tendency is necessary. Lacking explicit data in this respect, I will explore the present generalization without further comment, emphasizing that a serious philological survey is necessary.

In other words, *lana* in (12b) has not incorporated to V to form a complex predicate, which would make it lose its referential properties. It is thus clear in this instance that the direct object intervenes between the Wh-phrase and the verb. Needless to say, this kind of example cannot be explained by either of the theories above.

I am willing to accept that none of the examples presented in this section is completely perfect, or even mildly acceptable for many speakers. This is not the point. The issue is whether, even for these speakers, there are significant contrasts between examples of this sort and ungrammatical instances of the sort seen in (1) above. In as much as these exist, the account cannot be unified. This may seem unwelcome to some, particularly to those who defend models of grammar which allow for construction-specific rules. Within the GB framework, however, this array of facts is entirely plausible, and furthermore welcome. The hope of accounting for this phenomenon if traditional grammarians were right in their observations is practically null, at least within current versions of the theory. However, if the thread that Mixtelena began to pull leads somewhere, it is perfectly possible that the phenomenon under discussion results from the typical conspiracy of interacting principles, in a rich deductive way.

3. An Analysis

A natural approach to a portion of the facts above was proposed in Uriagereka (1987), some of whose mechanisms were discussed in Laka and Uriagereka (1987). The main idea comes from assuming the characterization of *barrier* explored by Fukui and Speas (1987), later on pursued by Uriagereka (1988) as in (13):

- (13) A is a blocking category only if A is a functional category morphologically specified.

This characterization is taken within the system of barriers in Chomsky (1986):

- (14) a. G is a blocking category for B [if]²⁰ G is not L-marked and G dominates B.
 b. G is a barrier for B iff (i) or (ii):
 (i) G immediately dominates D, D a blocking category for B;
 (ii) G is a blocking category for B [, G not IP].
 c. A L-marks B iff A is a lexical category that Theta-governs B.

To this, the natural assumption that *pro* is not a lexical specifier was added.²¹ For concreteness, assume that *pro* is not indexed until its reference is set, whenever and

(20) Of course, Chomsky's was an "if-and-only-if" statement, which we have to weaken now in light of the added proviso in (13). Needless to say, by incorporating (13) into (14a), we can turn the —if—, again, into an —if-and-only-if—. We will leave things as stand, though, for clarity.

(21) The first one to suggest this view is actually Chomsky (1986). When discussing the well-known paradigm in (i) and related examples, he notes:

- (i) a. ?? which car did John tell you [how Bill fixed t]
 b. which car did John tell you [how PRO to fix t]

"It may be that the [...] variation involves not the distinction tense vs. infinitive but [...] perhaps some factor involving nonrealized subject." (p. 39.)

however that happens.²² From this point of view, all that we have to do is substitute "indexed" for "morphologically specified" in (13) above. The intuition is that unspecified functional categories (and for us, categories specified by unindexed *pro* are unspecified) provide a "window in time", so to speak, for extraction across them.²³

The ungrammaticality of (15a), vis-a-vis the grammaticality of (15b) is now accounted for, assuming with many recently that IP *can* be a barrier in languages with rich inflection (contra the exception noted in (14bii)).²⁴ Notice that what this means, in effect, is that for the languages in point we can substitute the word "barrier" for "blocking category" in (14) above. The analysis is then straightforward:

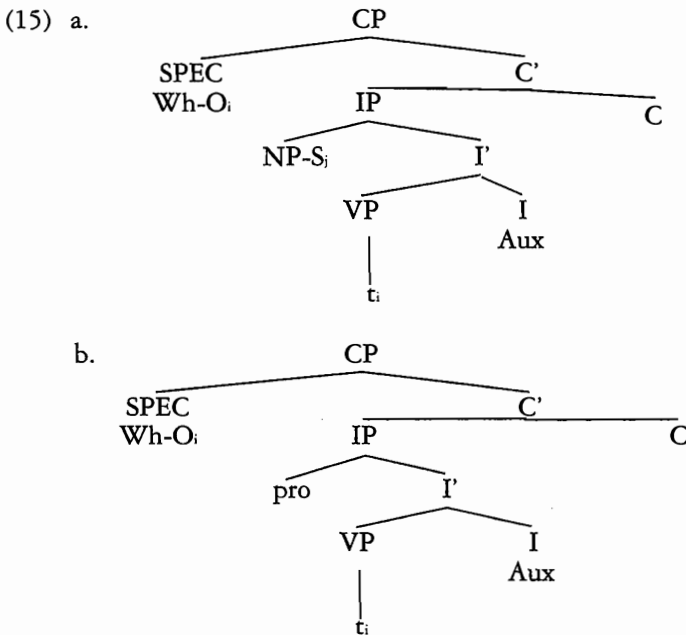

Below we return to the specific principle of grammar being violated (whether Subjacency or the ECP) —for now, assume that movement across a barrier is impossible. If this is the case, and blocking categories are taken as in (13), then IP is a barrier in (15a), not in (15b), where it is not morphologically specified.

In this account, thus, (i) a well-behaved structure for Basque phrases, coherent with what we know about them and learnable by the child, is postulated; (ii) a standard treatment of *Wh*-movement is assumed; (iii) the descriptive facts follow from

(22) Either by a generalized rule of Control, of the sort in Huang (1984), or by some sort of discourse closure, as in Heim (1982).

(23) This view of bounding (or some version of it), apart from being useful in the contexts cited, is crucial in accounting for completely unrelated sets of data, such as the ones in Fukui (1987), Tiedeman (1989), Raposo and Uriagereka (1990), Boyd (1991), and several others recently.

(24) For instance, Ambar (1989), Rizzi (1990), etc. make this point. This, of course, should be the null hypothesis, for having IP being an exception to the system of barriers needs further assumptions. In fact, Chomsky was always rather clear in pointing out the defective nature of IP *in English*, admitting that parametric variation could exist (as it obviously does, morphologically) in the IP system.

independently attested properties of the language, such as the possibility of pro arguments. The analysis is radical in that it takes the surface adjacency between the Wh-phrase and the verb to be a trivial, PF phenomenon, not a deep property of syntactic structures. But this is only radicalism from a traditional point of view; from a GB point of view, the analysis is extremely conservative and, in fact, rather standard.

For completeness, we also have to worry about examples like (16) and the like, where a direct object moves over an indirect object, also ungrammatical:

- (16) *zer pro Joni bidali dio
 what Jon sent III-have-III-III
 'What has he sent to John?'

For this we will assume current research within datives stemming from Kayne (1984), which equates them to subjects (e.g., Larson 1988). Torrego (in progress) goes even further: for her, said elements are specifiers of a functional category. Given this assumption, the rest follows. (We return below to a specific characterization of Basque VPs.)

In turn, this approach explains directly why movement across event adjuncts is fine (cf. (10)): these simply are not specifiers, hence no barrier is crossed.²⁵ As for why movement of event adjuncts is fine (cf. (9)), we will assume the analyses in Uriagereka (1988) and Hornstein, Rosen and Uriagereka (in progress), where it is argued that said elements do not involve trace variables, but rather event variables.²⁶ This, incidentally, may seem to decide that the issue at stake is the ECP, for this principle would be vacuously satisfied if no traces are at issue. However, Uriagereka (1988) argues specifically that true adjuncts do not need to undergo Wh-movement,

(25) In Hornstein, Rosen and Uriagereka (in progress) we argue that certain so-called adjuncts are specifiers of sorts, maybe differing parametrically from language to language—a view advocated, for instance, by Zagana (1988). These typically are unique, rather fixed with respect to where they are generated, and often show certain agreement with the verbal chain—e.g., temporal adverbs “agree” in tense specifications with the verb. It is possible, in fact likely, that said adverbs do induce a specificity effect of the sort noted here for subjects and indirect objects—this matter, though, is beyond my scope here.

(26) Event adjuncts do not specify the event, the way other argument-adjuncts do. (Incidentally, “Event” here is used in a vague Davidsonian way, to denote actual events, states, and so on.) Thus, if we say that John left the room at 5 o'clock, we are clearly specifying that event in a unique way. Hence, for instance, John cannot leave the room at 5 o'clock at 6 o'clock. In contrast, if we say that John left the room because he was tired, nothing prevents us from saying that he left the room because he was tired because he reached the conclusion that whenever he is tired he should leave the room (where this clause does not modify the reasons for being tired, but the leaving because John was tired). There is a beautiful infinite regress that Lewis Carroll constructed essentially this way, where the Turtle told Achilles that Socrates is mortal because Socrates is human and humans are mortal, because it is true that if Socrates is human and humans are mortal, then it is true that Socrates is mortal. If the argument seems fallacious to you (which is not, if Gödel is right!), consider the version: Socrates is mortal because Socrates is human and humans are mortal, because logic dictates that if Socrates is human and humans are mortal, then Socrates is mortal. Needless to say, we can add that it is true that logic dictates that if... and that it is true that it is true that logic dictates... And so on; all of these can be turned into causal statements, and we then have an infinite set of causes for a simple copulative statement—and the language obviously allows this. Of course, these are somewhat artificial examples, but more natural examples can be constructed whenever we have a system with rich causal implications. The point is, causal relations do not specify an event, they only add properties that this event (or this event modified by a cause, and so on) has. Thus, we want to treat them rather differently from other event dependents involving variables.

but can be base-generated in the spec CP. If this is possible, then a Subjacency explanation could also be invoked, at least in principle: there simply is no movement here. We shall return to these matters.

The most interesting case of all is now (11)—in fact a case that has not been successfully analyzed in the literature. Note, first, that our theory would seem to predict why examples of this sort are possible: the moved Wh-phrase does not appear to cross any barriers if analyzed as follows:

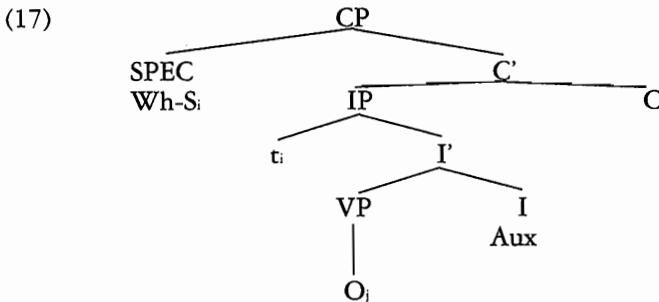

In Laka and Uriagereka, we analyzed the case in point as in (17), which created all sorts of technical problems for our analysis. This was the case, too, with minimal differences of detail, in Uriagereka (1987), again with problematic consequences.²⁷ These were all mistakes. We can show indeed that an analysis as in (17) would be incorrect, and definitely not predicted by our theory. Consider (17) *prior* to movement:

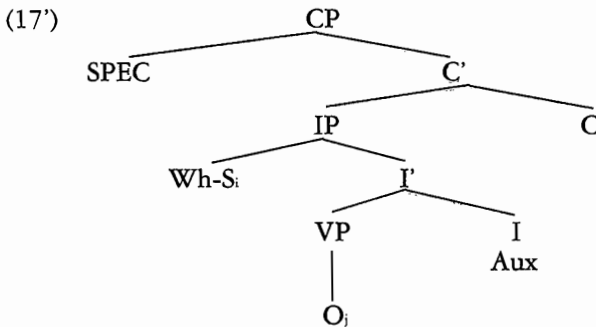

(27) Inherited in the analysis in Cheng and Demirdash, who propose exactly the same solution as the one in the paper in point. To simplify matters, the logic goes like this: Principle P demands that the verb be in a configuration that allows head government of the trace of the subject. This is, for cumbersome reasons I do not want to go into, impossible in these instances. The problem is *what follows* from this. Both Cheng and Demirdash on the one hand, and Uriagereka previously, concluded that the sentence should be marginal, since it only violates Principle P, whereas ungrammatical examples like (1) violate *both* P and whatever the relevant principle is that (1) violates anyway—ECP or Subjacency, let us say. Therefore, we all concluded, this sentence is “less bad”. Unfortunately, as Chomsky (personal communication) pointed out, this is not at all what seems to be happening. If Sarasola’s observation is correct, for some speakers, or perhaps even for some dialects, sentences of this sort are fine, not marginal. For others, they are marked—again, not bad in any clear sense. It could be added, in fact, that for some speakers, or perhaps even for some dialects, these sentences are clearly as bad as (1). No principle of grammar should yield these results. The solution below avoids these difficulties.

Here we can see that the *Wh*-phrase is clearly specifying IP. Movement from there, if IP is a barrier, should simply be impossible (essentially the same point was raised by Rizzi (Class Lectures, Fall 1987, MIT) for Italian.)

To see how the analysis now been rejected was indeed an oversight of both Uriagereka (1987) and Laka and Uriagereka (1987), consider versions of (18) in any language:

(18) *[what [did you ask [who [t wondered [who [t saw t]]]]]]

Sentences of this sort are quite bad, even in languages that allow rather free extraction. Now notice: if it is the case that IPs specified by traces cannot be blocking categories, the sentence in (18) should not violate a thing. The IPs are not blocking categories, hence cannot be barriers inherently. The CPs are L-marked, hence cannot be barriers inherently. The CPs are not barriers by inheritance either, since by hypothesis they do not immediately dominate a blocking category: IP. Of course, if IP is indeed a blocking category in these instances, then the ungrammaticality follows, with degrees varying depending on the status of IP itself, and other parametric matters having to do with CP, etc. But if IP is a blocking category, then the analysis in (17') should yield an ungrammatical result in a language where IP can be a barrier, like Basque.

Rizzi uses exactly this kind of reasoning to argue that extraction of subjects in Italian is always from a VP internal position (with an expletive *pro* being in [NP, IP] in (19) below, co-superscripted to the subject trace), and not from the specifier of IP. Suppose this is correct. Then, minimally, we should be extracting subjects from a site as in (19) for the derivation to stand a chance, details aside:

(19) $_{CP}$ [$_{Wh-S_i}$ $_{IP}$ [$_{pro^i}$ $_{VP}$ [...DO...V... t_i]] Infl] Comp]

What we have to ask ourselves now is what *exactly* is the position occupied by the direct object.

The interesting point here is that objects in Basque agree with the verb. Already in Uriagereka (1987) it was pointed out that, if agreement relations of this sort are head-spec relations, then it should be the case that objects occupy some kind of agreement marker. It was further pointed out that the shape of the auxiliary in Basque mirrored the shape of the arguments, an observation that, according to Laka (1988), is as old within Basque studies as early grammatical analyses of the 19th century. This observation is relevant because, in the spirit of Baker's (1988) work, it points out to a clear hierarchy within VP, to map the correct morphological shape. This is what Laka (1988) does. Cheng and Demirdash pursue Laka's analysis to propose an explicit syntax for clauses in Basque, which we shall review below. Suffice it to say, for now, that provided that agreement with object is shown, this element is in the specifier of an AgrP (see Chomsky 1988 for discussion of this kind of proposal).

The only point that should concern us at this stage, details aside, is that if there is indeed an AgrP of some sort, and it is lexically specified by the direct object, this phrase must constitute a potential barrier. The reason why this is relevant is that, for many speakers, the sentence in question is indeed bad. This follows if, apart from the impossible analysis in (17'), an analysis as in (20) is *also* ungrammatical:

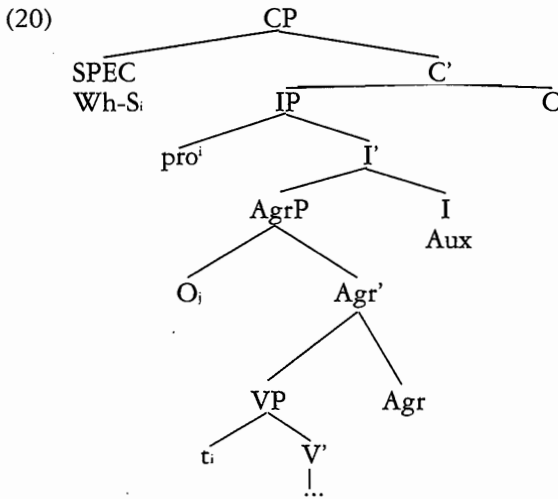

As explicitly proposed in Uriagereka (1987), and developed fully in Laka (1988), the Agr element ends up being part of the auxiliary. (The operations are even more complex in dyadic predicates; we return to the details of the whole process in the next section.) But at this level, AgrP is indeed a barrier for the trace of the subject in its VP internal site. Therefore, there is no way of generating the relevant sentence... Or is there?

4. Vacuous Movement

Well, if there is not, we are in trouble explaining the dialects or idiolects where this kind of sentence appears to be fine. The answer to this puzzle comes from the Vacuous Movement Hypothesis of George (1980), discussed in Chomsky (1986). The structure in question is as in (17'), but not at an intermediate level; rather, (17') is an *S-structure*. Chomsky (p. 48-50) raises the following issue:

...a language may have either syntactic Wh-movement (English), LF Wh-movement (Chinese, Japanese), or both (French). Considerations of language acquisition suggest another possible option. [...] Example (104b) [equivalent to S-structure (17')] ... is consistent with the assumption that [syntactic Wh-movement] does not take place. [...] We might suppose that the unmarked case for a language with overt Wh-movement is that it always takes place at S-structure, so that nonmovement of subject in English [and Basque] would have a somewhat marked character. [Underscore added.]

If this approach is correct, we expect the peculiarity and apparent randomness of these structures, and that in as much as they are possible they will appear only with declarative order. This last point turns out to be extremely hard to test. Needless to say, one obvious way, at least in principle, would be to move *long distance* a subject Wh-phrase, to make sure that actual movement has indeed taken place, thus preventing a vacuous movement analysis. As we shall see, however, this has further complications.

Notice, first, that another peculiarity of Basque can be explained in terms of the assumption about where direct objects are expanded in this language. Goenaga (1984) noted that extraction from nominals is impossible in this language, even when the nominals in question are in object position:²⁸

- (21) a. *nori esan duzu
 who-dat said III-have-II
 [t buruzko istorioak] entzun dituzuela
 about stories heard III-have-II-comp
 ‘Who have you said that you heard stories about?’
- b. *noren esan du
 who-gen said III-have-III
 [t istorioak] entzun dituzuela
 stories heard III-have-II-comp
 ‘Who have you said that you heard stories of?’

As Uriagereka (1988) notes, Goenaga’s observation follows naturally if arguments in Basque are in spec positions, therefore are “subjects” of sorts—in technical terms, explicitly advocated by Cheng and Demirdash, external arguments. As is well-known, extraction from subjects (more generally specs) is normally barred. This follows if said elements are not L-marked, unlike complements, which are directly Theta-marked by the verb.²⁹

Comparable facts hold in Spanish, and a comparable explanation is possible if Torrego (in progress) is correct that certain direct objects in this language are externalized: precisely those which are introduced by the marker *a*. Thus, we see the minimal contrasts between (22) and (23):

- (22) ?Juan es el tipo de quien conozco varios críticos t
 Juan is the guy of whom know-I several critics
- (23) ?*Juan es el tipo de quien conozco a varios críticos t
 Juan is the guy of whom know-I to several critics

It is significant (crucial in her account) that in many dialects of Spanish it is the elements which can take *a* that may invoke clitic doubling. Arguably, clitic doubling is an abstract form of agreement, and the grammar is treating both phenomena alike.

(28) Uriagereka (1988) observes that there can be nothing wrong in principle with the relevant questions, for they appear when *wh*-in-situ is invoked in multiple questions:

- (i) nork esan du
 who said III-have-III
 [noren istorioak] entzun dituzuela
 whose stories heard III-have-II-comp
 ‘who has said that you heard stories of whom?’

(29) On the other hand, Javier Ormazabal notes that the sentences in (21) are truly terrible (worse than those in (22) and (23) below in Spanish)—so it is entirely possible that, apart from the violation in point, something else is at issue as well.

This, note, should predict that extraction from *any* argument, including clausal ones, is impossible in Basque. Obviously, this is not true; just extraction from *nominal* arguments yields ungrammatical results, thus the perfect instances of extraction from completive clauses in (24):

- (24) a. nor etorri dela esan duzu
 who come II-is-comp say III-have-II
 'Who have you said has come?'
 b. nor esan duzu etorri dela

In (24a), it can be argued that the whole embedded clause has been pied-piped, a proposal made explicitly by Ortiz de Urbina (1989) —clausal pied-piping being a process that he and others motivate independently for languages like Quechua. But this analysis is impossible for (24b). There, it is only the operator *nor* that has moved, the CP having been right-dislocated prior to movement. The dislocation, per se, cannot be enough to devoid the completive clause of its barrier status, or else we will rule in the incorrect examples in (21), where some kind of right-dislocation of the object has taken place. But another question is in order: is it clear that this structure involves movement of the question element *nor*?

If Torrego and Uriagereka (in progress) are correct in their analysis of *apparent* extraction from indicative clauses, this need not be the case. In particular, we argue that an empty operator Op may move internal to islands up to their periphery, where it can hook-up to a 1-subjacent scope-marker to form an "extended X'-chain", in the sense that Chomsky (1986) gives to these elements.³⁰ This way, we analyze among several others the sort of German data discussed in McDaniel (1989):

- (25) wie hat er gesagt, wie er malen würde
 how has he said how he paint would
 'How did he say he would paint'

(25) is a matrix scope question, yet Wh-movement proper takes place only in the embedded clause. The rest is an extension of the chain (*wie, t*) to the matrix scope marker *wie*. Torrego and Uriagereka argue that this sort of analysis is always a (marked) option when extraction from islands is at issue, with many languages not displaying overtly the real operator (thus giving the illusion that actual movement out of an island has taken place). Of course, the process is not entirely free, but rather is constrained to domains where 1-subjacency between the scope marker and the real operator is possible (i.e., presence of no more than 1-barrier; —in other words, adjacent domains).

It is thus possible to analyze (24b) as in (26), the paradigmatic instance of extraction from indicative clauses in Torrego and Uriagereka:

(30) Chomsky uses this notion to account for parasitic gap constructions. Browning (1987) extends the idea to other constructions, and explores their implications. The crucial property of extended X'-chains that concerns us here is that they involve locality between the empty operator and the overt element which serves as a scope marker (and in instances of parasitic gaps is itself an overt operator).

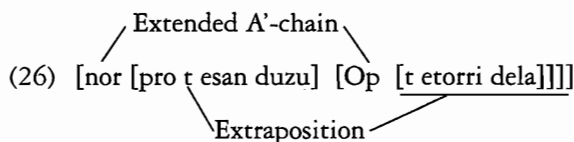

Assuming that the extraposed clause is an island, no other island can intervene between *nor* and Op; thus, we predict correctly that the subject of the matrix sentence must be *pro*, etc. The reason why this analysis does not extend to the ungrammatical (21) must be that, unlike clauses, which have the specifier of CP as an operator site, NPs lack this site. We know this to be true independently, as the contrasts in grammaticality in (27) show:

- (27) a. ?who did you hear yesterday that John will marry
 b. *who did you hear yesterday a rumor that John will marry

(27a) is, at worst, marginal. Again, the strategy proposed in Torrego and Uriagereka should be available here, even if, for whatever reason, extraposed clauses of this sort are islands.³¹ However, if this strategy were operative in a displaced NP as in (27b), then this sentence should be good, which it is not.³²

Now we are ready to construct our test Case for the Vacuous Movement analysis of (17') above. Consider first (28):

- (28) *nork esan duzu lana egin duela*
 who said III-have-II work-the make III-have-III-Comp
 'Who have you said has done the work?'

This sentence does not seem bad at all. However, we have no simple way of knowing whether *lana* has indeed stayed in its A-position, or whether, instead, it is displaced in some peripheral position. But now we can control for this. Take (29):

- (29) **nork ez dakizu nori liburua bidali dion*
 who not III-know-II who-dat book-the sent III-have-III-III
 'Who don't you know to whom sent a book?'

The key element here is *nori*. If it has moved at S-structure, the extended chain (*nork*, Op, *t*) cannot be formed, for the specifier of the embedded clause is taken by *nori*. But suppose that, as we are assuming, *nori* has indeed the option of staying put, just as we are claiming *nork* does in a sentence like (17'). Now we have trapped *liburua* in its A-position! And the sentence is quite terrible, as expected. The problem is, in particular, the one raised in the analysis of (20): *nork* is moving over an AgrP specified by *liburua* in its A-position. Therefore we conclude that Vacuous movement is

(31) See Johnson (1985) for extensive discussion.

(32) Notice that Case assignment to *rumor* cannot be an issue, for when no extraction from this element is taking place, the result is perfect:

(i) I heard yesterday a rumor that John will marry Sue

In general, heavy NP-shift seems to void the adjacency requirement for Case assignment which operates in English. Note, finally, that when the object is not dislocated, extraction out of it is only marginal:

(ii) ?who did you hear a rumor that John will marry *t*

indeed the explanation for examples like (17') (and only those), for people who allow for this strategy to begin with.³³

5. The Realization of Arguments in Basque

Crucial to the analysis above is a certain array of arguments in Basque which involves externalization of what in many languages is usually an internal argument. We should preface these comments by saying that we are only beginning to understand what constitutes an internal argument. The view that only the thematically higher argument is external is untenable in light of recent investigations, at least if by "external to XP" we mean something with the import of "not-being-governed-within-XP". This is not to say that there is no designated "highest" argument with a peculiar set of "subject" properties; whatever the answer to this is, it does not entail that the rest of the arguments are necessarily "complement"-like. Here is a domain where a great deal of linguistic variation arises, although within certain interesting limitations. For instance, for the most part it seems that languages obey the Thematic Hierarchy in terms of externalizing arguments. In turn, it appears that certain implications apply, such as: if a language externalizes a low argument, all higher arguments must be externalized as well; and so on. We study these matters in Raposo and Uriagereka (in progress).

Recently, Cheng and Demirdash have studied the properties of Basque VPs, and argued that all arguments in this language are external to this phrase. Actually, they consider two possibilities: that the arguments are indeed external at S-structure is quite straightforward; but are they also external at D-structure? Cheng and Demirdash argue that this is indeed the case, but their arguments on this are extremely theory internal and, as it turns out, rather weak. Their specific proposal goes as follows: (i) All arguments are base-generated in the specifier of AgrPs. (ii) The arguments of the verb are projected according to the Thematic Hierarchy. (iii) All arguments are indirectly Theta-marked. (iv) Case is assigned by the Agr markers.

It is easy to see that, in principle, (ii) is straightforward and (iv) can be true even if arguments, instead of being base-generated in the specifiers of AgrPs (i), move there by S-structure. Part of their motivation for keeping (iv) as such is that they are following (loosely) Levin (1984) in arguing that all Case in Basque is assigned inherently; therefore, they must find a way in which Case assigners are identified with Theta-markers (hence, (iii)). However, the spirit of Chomsky's (1986b) inherent Case is clear: this process is an implementation of the traditional idea of lexical Case; in a nutshell, certain heads bear an idiosyncratic Case relation with respect to their s-selected argument, which Chomsky wants to capture at D-structure. He explicitly proposes, following a long tradition, that only internal arguments are s-selected.³⁴

(33) This answer is of course possible within Ortiz de Urbina's analysis; it is harder to motivate for Eguzkitza's, though, since his assumptions about Wh-movement are entirely different.

(34) Chomsky goes as far as to saying that "if D-structure is to be regarded as a pure representation of theta structure, it would be reasonable to suppose that lexical items appear at this level in a "reduced" form lacking inflectional elements that do not affect theta-marking and do not enter into s-selection." (p. 157) If this is interpreted literally, as has been the case by many recently, either such elements are not present at D-structure *at all*, or if they are, they have nothing to do with thematic relations. (Of course, Chomsky's quote leaves the door open for certain inflectional elements that do in fact affect theta-marking; this, however, is not the null hypothesis, and needs independent evidence.)

This being the Case, the Cheng-Demirdash proposal of having all arguments in Basque being external at D-structure essentially entails, contrary to what they state, that no inherent Case should be assigned to verbal arguments in this language.

Facts with respect to Case turn out to be a bit more complex than what Cheng and Demirdash assume, and Levin, among others, was well aware of this. The central reason for Chomsky's having inherent Case at D-structure is that it is Theta-related. But consider the following data from Laka and Uriagereka (1987):

- (30) a. Marik atea ireki zuen
 Mari-erg door-the-abs open aux
 'Mari opened the door'
- b. giltzak atea ireki zuen
 key-the-erg door-the-abs open aux
 'The key opened the door'
- c. Marik atea giltzaz ireki zuen
 Mari-erg door-the-abs key-the-instr open aux
 'Mari opened the door with the key'
- d. Jonek pardela jaso zuen
 Jon-erg package-the-abs receive aux
 'Jon received the package'
- e. Joni pardela bidali zioten
 Jon-dat package-the-abs send aux
 '(They) sent the package to Jon'
- f. hitzaldiak Joni probetxu egin zion
 talk-the-erg Jon-dat benefit do aux
 'The talk instructed Jon'
- g. Joni hitzaldia gustatu zitzaion
 Jon-dat talk-the-abs like aux
 'Jon liked the talk'

At first glance at least, in the examples above many arguments which are arguably receiving the same Theta-role are nevertheless getting different case endings (e.g. *giltzak* 'the key-ERG' *giltzaz* 'the key-INST'); conversely, many arguments receiving the same case endings are satisfying very different Theta-roles (*Mari-K* is an agent in (20a), *giltza-K* is an instrumental in (20b), *Jone-K* is a goal in (20d), *hitzaldia-K* is a cause in (20f)). Of course, one could argue that, in spite of appearances, examples of the first sort involve *different* theta roles, whereas examples of the second sort involve *the same* theta role; this, though, apart from begging the question, would essentially render studies on Argument Structure entirely vacuous. Alternatively, one may argue that inherent Case has nothing to do with *specific* Theta-roles, but rather with the process of assigning *some* Theta-role or other to a given argument. The effects of this would render vacuous the entire motivation for inherent Case as a lexical Case. In either instance, we would also have to give up a principle implementing universal

alignment of the sort pursued by Perlmutter and Postal (1983), such as Baker's (1988) UTAH within GB.³⁵

There are other reasons to conclude that not all Cases in Basque are inherent. Consider (31), cited in Uriagereka (1988):

- (31) a. JRek Bobi Pam joerazi zion
 JR-erg Bobby-dat Pam-abs hit-cause aux
 'JR caused-hit Pam to Bobby'
 b. JRek Bobbyk Pam jo zezan egin zuen
 JR-erg Bobby-erg Pam-abs hit aux make aux
 'JR caused that Bobby hit Pam'

(31a) is a standard causative construction. There is no clear sense in which the subject *Bob-I* of the event caused by JR is theta-related to anything other than this very event. When the sentence is expressed in a bi-clausal form (31b), this fact is obvious (note that in this instance the case ending in *Bobby-K* is ergative). Yet in the Cheng-Demirdash account the element in point must be receiving dative case from the agreement element encoded in the main event auxiliary. In fact, the case received by *Bobby* in (31a) appears to have little to do with its Thematic status —either this, or we would have to give up a bi-clausal analysis of (31a) of the sort proposed elsewhere by Baker for similar instances.

There are other arguments that can be constructed against the Cheng-Demirdash interpretation of Levin's work with respect to Case; however, since a coherent picture of Case assignment is not at issue here —and at any rate, seems far from focused at this point— we should rather concentrate on what all of this tells us about the part of their account that has to do with the externalization of arguments. In essence, what we have seen vanish is part of the motivation for said externalization taking place at *D-structure*. The spirit of their proposal lives on a hunch that many have toyed with in the past: that objects in Basque are not lexically governed, which they explicitly propose. Data of the sort discussed in (12), extended now, argue against this view:

- (32) a. Jonek lana egin du
 Jon-erg work-the-abs make III-have-III
 'Jon has done the work'
 b. Jonek lan egin du
 Jon-erg work make III-have-III
 'Jon has worked'
 c. lanak nekatu nau
 work-the-erg tired I-have-III
 'Work has tired me'
 d. *lan(ek) nekatu nau
 work-erg tired I-have-III
 ('work-tiring has happened of me')

(35) Crucially, the same Thematic relations would be expressed via different D-structure positions, and the same D-structure positions would be expressing different Thematic relations.

Noun incorporation from subject position is impossible, as is usually the case. In Baker's theory of Incorporation this fact follows from the subject not being head governed by the target of its incorporation. If, in turn, the object can indeed incorporate (as shown in (32b)), then it must be that this argument is indeed head governed at the level when incorporation proceeds —i.e., presumably in the mapping from D-structure to S-structure.³⁶

The specific reasons that Cheng and Demirdash give for why arguments are not externalized only at S-structure in Basque are the following. "First, how do we ensure that the NPs end up in precisely the spec positions where they get the right Case and trigger the right agreement?" The only answer to this question that they consider is stipulating that each agreement element is restricted to the right kind of argument. Raposo and Uriagereka (in progress), following many others recently, argue that all clitic/agreement elements start within the VP projection, as determiners heading DPs of which the actual argument is the specifier and pro the complement (for the details and source of this idea, see Torrego (in progress), and below). If this is correct, the undesirable stipulation is rather a natural D-structure fact: the NPs end up in precisely the correct spec positions because *there* is precisely where they start (we will make this more precise soon). The other difficulties that they raise are essentially two technical versions of the question above. One is too cryptic even in their paper to be discussed seriously;³⁷ the other one, though, merits some careful attention.

6. Specifiers, Agreement, and Auxiliaries.

Consider the structure they discuss—and reject (their (13)):

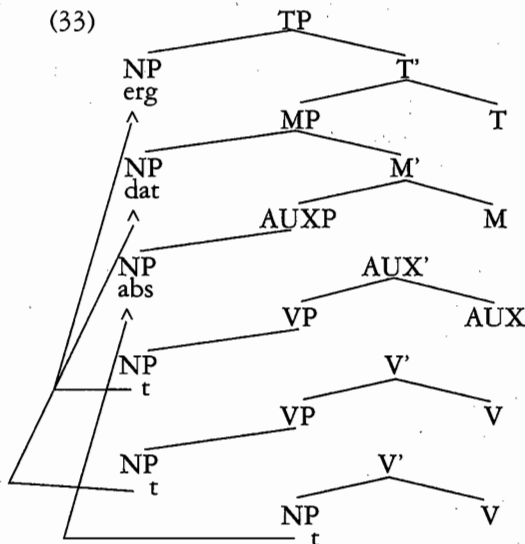

(36) Alternatively, of course, Baker may be wrong, but that needs independent evidence.

(37) "NP-movement of all the arguments leads to Crossing Paths. Pesetsky (1982) has argued that crossing paths are only relevant to A'-movement. However, with the proliferation of functional categories and the VP-internal hypothesis, we have a proliferation of A-positions (i.e., positions in which Case or a Theta-role are assigned). Hence, the question of whether crossing is relevant for A-positions only arises now." (sec. 3)

Here is their worry: "NP-movement in [33] entails ECP violations: the relations between the traces in [33] and their antecedents are not local. The intervening traces/NPs will act as specified subjects. In other words, they induce minimality violations." There is indeed an issue here, internal in fact to our analysis of (20) above. Recall that we want to prevent Wh-movement of a subject internal to VP over an object in an agreement projection (in terms of (33), Cheng and Demirdash's AUXP, following Laka); how then is it possible for the subject to A-move to subject position?

There are several matters to discuss here. First, we have to address a serious conceptual difficulty with (33) and much related work. What does it mean to say that an ergative (subject) phrase can specify a T(ense)P(hrase)? What does it entail that a dative phrase can specify a M(odal)P(hrase)? What is the mapping of the semantics going to look like in instances of this sort? The notion specifier is first used consistently for phrasal purposes in Chomsky (1970), where it has a clear (and obvious) semantic correlate. In Jackendoff (1977), there are rules of correspondence between syntactic specifiers and semantic specifiers. What the latter do, essentially, is take the reference of the XP they are related to —typically, some sort of set— and operate on it to yield a subset; thus, say, *the (unique) picture* takes the set Picture (x) and yields the singleton set ('x) [Picture (x)]. Needless to say, the more transparent the relation is between a syntactic specifier and its head, the more straightforward the mapping to a semantic specification is going to be. From this point of view, it should be obvious that a Tense Phrase, if this notion is going to carry any weight—that is, essentially, that this is a phrase and it expresses, when computed semantically, say, tensed actions— cannot be specified by an entity like *John*, although it may be specified by a temporal adverbial like *yesterday* or whatever. Similarly, a Modal Phrase may be specified by an adverb of mood, and so on. Zagana (1988), among others, takes this route recently for some auxiliaries in English.³⁸ I am not interested in questioning now whether in fact syntactic specifiers *have to be* transparent—though I think there are several arguments to this effect—and rather will simply propose that a more plausible approach to the matter at stake is that, although the geometrical shape of (33) is essentially correct, the labeling is not. In a sense, this is a minor point, then, which can be used to our benefit.

Suppose that, as hinted at above, the relevant structure is rather of the form in (34)—simplified now to transitive structures:

(38) In fact, the idea goes back to Tomas of Erfurt in the thirteenth century, who in a brilliant move argued that certain circumstantial dependents agree with the verbal projection much like adjectives agree with the nominal projection (see Covington 1984).

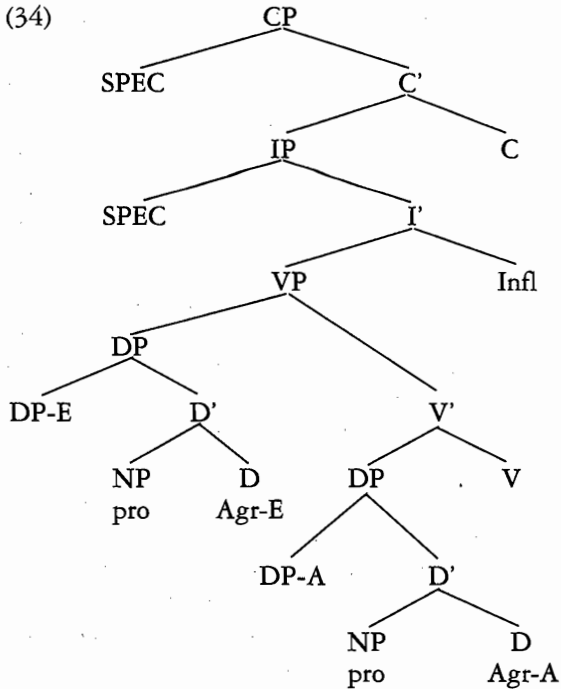

I return shortly to a more accurate representation of Infl. To have agreement markers discharging Thematic roles, following the analysis of clitics by Torrego that goes back to Postal (1969), is rather natural. Torrego, in fact, makes the insightful proposal that agreement markers seen as determiners with their own projection provide a direct solution to the difficult problem of clitic doubling: doubled phrases are occupying merely the specifier of the DP headed by the clitic. Several recently have extended this view to Agreement in general, to unify it to an analysis that was implicit in Rizzi (1982) within this framework, and is in fact in line with well-known traditional observations about clitics and agreement markers and their diachronic and synchronic correlations. (Among several discussing this approach, see Fernandez 1988, Galves 1990).

(34) is mapped into S-structure (or intermediate levels) by way of an operation of incorporation—in effect, analogous to clitic placement to Infl in Romance. If Laka is correct in her analysis of the auxiliary system, it is likely that this incorporation is going to be non-trivial, with different agreement markers landing in different functional categories. What I am not convinced about is that these categories are the ones she specifically has in mind. Let us be precise on this. The structure that Cheng and Demirdash propose differs from Laka's in that, in theirs, AGREEMENT phrases are postulated:

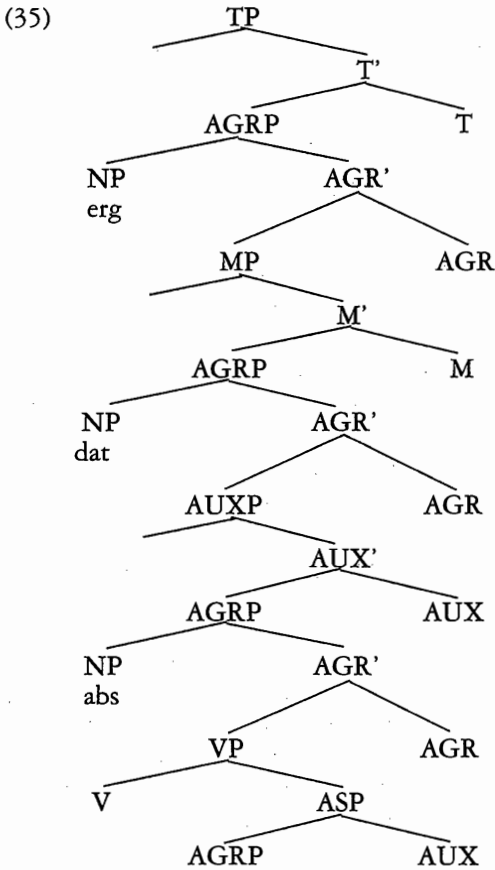

This is probably correct, except that I am suggesting these agreement phrases start not where Cheng and Demirdash expand them, but rather VP internally. Another question remains, though: what exactly are TP, MP, AuxP and the like? Laka had these categories for two reasons: (a) because they seem to play a role in determining the morphological shape of the auxiliary; (b) because she needed specifiers for her arguments. Cheng and Demirdash in a sense trivialize this last point by invoking their Agreement Phrases the way they do. If however we ship these phrases back to D-structure, then it still is an open question whether Laka's specifiers are to be used, and if so why.

The latter is a very tricky question, which sends us into a marage of proposals in the last few years concerning the "davidsonian" and/or aspectual structure of clauses. If Higginbotham (1985) is correct in bringing Davidson's (1966) proposals about events to bear on the syntax of clauses, and in particular Infl, Laka's inflectional categories may have to be evaluated within this light. Some of these categories may have nothing to do with the obligatory expansion of predicates; thus, I am suspicious that, in particular, Tense may have to be relativized to whether the sentence under analysis is in fact tensed (internally or depending on another Tense, as in comple-

ment infinitivals) or rather is somewhat nominal in character (as in subject infinitivals, and other comparable structures). The same could be said about M(odal), perhaps. At any rate, regardless of whether Laka's specific categories bear the names to be expected in an obligatory expansion of a canonical clause, *some* category must do the job. Basque is rather straightforward in invoking in productive verbs obligatory auxiliaries *have* and *be* for transitive and unaccusative structures. Therefore, at least these auxiliary elements must be there, and if they are one wonders what their task is. I do not plan to give an exhaustive answer to this here,³⁹ and rather I will simply conjecture that these obligatory functional categories in fact introduce davidsonian structure. In this, I am essentially following Higginbotham, although I will extend his proposals to claiming that n -adic predicates in Basque invoke n auxiliaries, and hence n davidsonian arguments. Intuitively, the happening structure of a clause will differ depending on the nature of the predicate. Roughly speaking, a (true) monadic predicate of an unaccusative sort will invoke a davidsonian argument introducing, say, a *situation* (which can be of different sorts, as in the ontology of Pustejovsky 1988) by way of an auxiliary like *be*.⁴⁰ In turn, a dyadic predicate will invoke a situation plus some kind of, say, *relationship* (for lack of a better term for states, events, and so forth), the latter being again another davidsonian argument introduced this time by an auxiliary like *have*. And so on; this is obviously nothing but a sketch of the notions involved, which surely will have to be explored more seriously.

Given this davidsonian structure, verbal arguments would move to the specifiers of the relevant auxiliaries; this specification would now have a straightforward semantic consequence, something I am not interested in exploring here in detail. That is, we would not be talking about weird specifiers now, but such simple-minded ones as *Nero* singling out a given *destruction of Rome* from the set of said destructions in *Nero's destruction of Rome*, etc. Essentially, then, we are dealing with structures as in (36) —again, simplified to transitive structures:

(39) But see Uriagereka (in progress).

(40) In this sense, a pure intransitive would not be monadic, which as Hale and Keyser (1986) note is easy to motivate for Basque, where these verbs show agreement with two arguments, even if the internal one is not explicit.

(36)

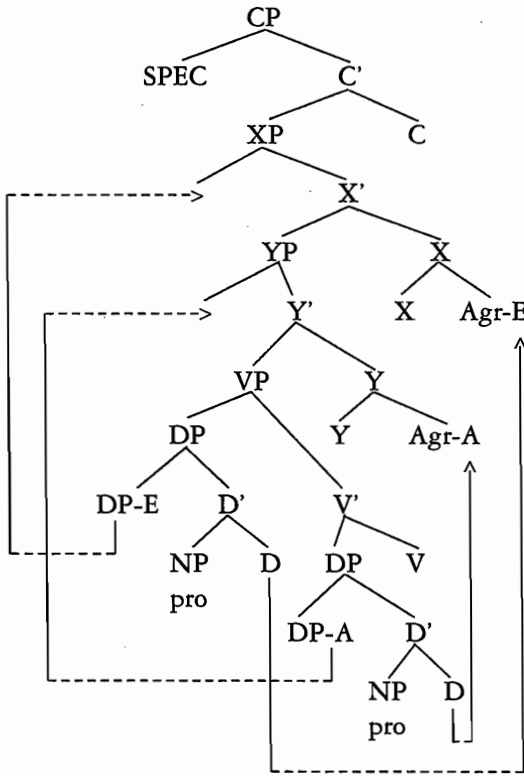

There are of course many matters here where I am not committing myself —only the obvious one being not giving specific names to auxiliaries. That can be fixed with fairly straightforward research. More challenging, it seems to me, is why it is that agreement markers (clitics in general) climb to the placement-sites they do. Or why it is that davidsonian arguments, when used sententially, appear to need to be specified (the Extended Projection Problem can be interpreted this way). Assuming there are answers to all of these intriguing questions, the structure above seems plausible. Note that the fact that what starts being a specifier of the object in D-structure ends up being in S-structure the specifier of the auxiliary to which the object has raised is natural, and probably follows from Full Interpretation (in other words, standard compositionality of the appropriate sort). Crucially, notice, all expansions above invoke reasonable types. That is, surely one can conceive of an auxiliary as something (perhaps a category shifter of the sort discussed in Partee 1988 and elsewhere) that, say, takes an action and turns it into a completed action or an action in progress, and other, more intriguing operations. It is not clear that agreement markers have any role to play in this clausal skeleton: they do not lift the type of anything, they simply encode (perhaps) the reference of the arguments that enter into the clausal skeleton.

7. Extended A-Chains

Now we are ready to answer the question that triggered all this discussion: why is the movement, for instance, of DP-E to XP permitted, even if it is presumably across YP specified by DP-A? The answer to this question is in terms of Chomsky's (1986a) analysis of A-chains. For Chomsky, there is co-indexation between V and I, as a form of what he calls head-head agreement. He needs this device to analyze, for instance, standard raising structures, as in (37):

- (37) a. John seems [t to be intelligent]
 b. John_i A[seem-I] [_{VP} t_i [_{IP} t_i to be intelligent]]

Chomsky associates the subject of IP with its head I; he then assimilates chain coindexing with the feature sharing of agreement. It then follows that $i=j$ in (37b), since *John* is co-indexed with its trace and agrees with *seem-I* (note that *seem* has raised to I from t_{-j}). The point he makes is then the following:

In [37], then, t_{-j} is governed by and coindexed with t_{-j} , the trace of the raised V. Under a slight extension of the notion of antecedent government, it would follow that t_{-i} is antecedent governed by t_{-j} , thus properly governed by it. Suppose that we now extend chain coindexing to include this case, in effect treating t_i as the final element of an extended chain—in other words, allowing the chain itself, via its terminal element, to properly govern t_i by antecedent government. We thus define "chain coindexing" as follows:

- (38) a. $C = (A_1, \dots, A_n, B)$ is an extended chain if (A_1, \dots, A_n) is a chain with index i and B has index i .
 b. Chain coindexing holds of the links of an extended chain.
 [p. 75]

Chomsky then worries (p.76-77) about NP-movement over modals and other aspectual auxiliaries; the obvious step he takes is to assume that "independent of raising, there is head-head agreement (index sharing) between I and the aspectual verbs; [...] hence, there is (indirect) agreement between the subject and each aspectual verb of VP. [...] This assumption will suffice to permit NP movement" in the instances Chomsky discusses, and obviously, in ours too, so long as the auxiliaries X, Y, etc. are equally co-indexed. For a thorough discussion of Chomsky's analysis and expansions, see in particular Zagana (1988).⁴¹

Needless to say, this extension of chains does not carry over to instances of A'-movement—in other words, C and Infl cannot be co-indexed in this extended sense, or else A-movement in Chomsky's sense would be extended all over. How and why this is is a matter which does not concern me here. I do want to point out, though, that regardless of Chomsky's technical implementation (clearly, there might be others),

(41) It might be argued that, provided that, say, DP-E ends up in the specifier of X, and DP-A, in the specifier of Y, X must bear the index of DP-E and Y, that of DP-A—presumably, these indices at least may be different. However, this is an entirely technical matter, solvable in various ways. It could be, first, that categories may bear n-tuples of indices, or that these devices are more complex than usually assumed. Alternatively, it could be that spec-head co-indexation only holds for unindexed categories.

what is at issue is rather straightforward: the verbal projection constitutes a unit of sorts, with various consequences; among these is that of allowing NP movement within it. The good instances of movement that we are forced to posit (or for that matter, anyone analyzing sentential arguments as coming from within VP) are contained within the extended projection of the verb via auxiliaries, all the way up to the top-most inflectional element. Comp has to be left aside from all of this; it clearly is the beginning of a new, independent skeleton with well known opacity characteristics, semantically and syntactically. The impossible movements to the specifier of Comp that we have seen in this paper —impossible, that is, for they are crossing lexically specified sub-projections of Infl— are nothing but garden variety instances of this opacity.

To conclude, note that taking Chomsky's approach essentially commits us to an analysis of the matters discussed in this paper in terms of the ECP, assuming that the principle at issue is something along the lines of (39):

(39) A trace is antecedent-governed.

Where government cannot proceed across any barriers, etc. This of course is also a technical issue, and there may be ways around it; for instance, one could void A-movement from being subject to the Subjacency condition, and similar results would be achieved. The important point, aside from these technicalities, is that Basque clauses are in fact rather standard, in all of their properties. Their quirks are nothing but a consequence of the parametric options they take, including, we now see, the externalization of all verbal dependents. These parameters, though, are trivial to set.

8. Conclusions.

Some researchers puzzle over facts like those presented in this paper, and try to find an answer that reduces the puzzle to the often perverse workings of universal grammar, showing through the quirks of a core-grammar set from various parameters. Others like to present facts like these as paradoxes for our present (or global) conception of principles, parameters, and so on. It takes a bit of an aesthetic impulse to choose either approach; at the present stage of our research, perhaps, little more can be presented as conclusive evidence, for evidence is easily produced in well-behaved labs... This is all to say that the present article should be taken with a grain of salt, a piece of advice which is perhaps unnecessary for some already sceptical audiences. Now, once suspension of disbelief is granted for a model instantiating universal principles and variational dimensions, it must be admitted that the approach presented here offers some progress over previously existing accounts, if these are seen in the light in question. Thus, I have tried to show that everything that is peculiar to Basque Wh-movement is peculiar to Basque in a more general way: as a result of set parametric options, where these dimensions of variation are independently attested for other languages. In turn, certain apparent peculiarities of Basque actually cease to be so when the system of universal grammar is appropriately (and somewhat naturally) modified to include these facts, in a way that does not apparently alter the predictions that we make for other languages. This is, I believe, the part of

the account which needs no more spices. But the salt is arguably to be expected in those domains which deserve further empirical investigation. For instance, a serious philological and dialectal research is needed for purely observational reasons with respect to some recalcitrant data discussed here. Descriptively, also, other complications arise in contexts where negative and emphatic operators introduce expressions, which induce further effects not explored here. After these ingredients are added to the pie, maybe some of my conclusions will have to be rethought. Nevertheless, even if new evidence points in new directions, I think that the present approach is internally consistent and elegant within the sub-theories it touches. In this respect, empiricist disclaimers aside, the analysis explores thoroughly a region of possible linguistic space —thus constituting progress even if it is only to reject contentfully an idea which is explicit, coherent, and plausible.

References

- Altube, S., 1929, *Erderismos*, Bermeo.
- Ambar, M., 1989, *Para uma Sintaxe da Inversão Sujeito Verbo em Português*, University of Lisbon, doctoral dissertation.
- Baker, M., 1988, *Incorporation*, Chicago University Press.
- Cheng, L. and H. Demirdash, (forthcoming), 'External Arguments in Basque', in *Studies in Basque Linguistics*, J.I. Hualde and J. Ortiz de Urbina, (eds.), John Benjamins.
- Chomsky, N., 1986, *Barriers*, MIT Press.
- , 1986b, *Knowledge of Language*, Praeger.
- , 1988, 'On The Economy of Derivations', *MIT Working Papers in Linguistics* reprinted in this volume.
- Covington, M., 1984, *Syntactic Theory in The High Middle Ages*, Cambridge University Press.
- Davidson, D., 1966, 'The Logical Form of Action Sentences', reprinted in, 1984, *Essays on Actions and Events*, Clarendon Press.
- Eguzkitza, A., 1986, *Topics in the Grammar of Basque and Romance*, University of California at Los Angeles, doctoral dissertation.
- Fernandez, O., 1988, 'Strong Pronouns in Null Subject Languages and The Avoid Pronoun Principle', in *Proceedings of the First Student Conference on Linguistics*, MIT.
- Fukui, N., 1987, *A Theory of Category Projection and its Applications*, Massachusetts Institute of Technology, doctoral dissertation.
- Fukui, N. and M. Speas, 1987, 'Specifiers and Projection', *MIT Working Papers in Linguistics*.
- Galves, Ch., 1989, 'Verb Movement, Levels of Representation, and The Structure of S', presented at GLOW.
- George, L., 1980, *Analogical Generalization in Natural Language Syntax*, Massachusetts Institute of Technology, doctoral dissertation.
- Goenaga, P., 1984, *Euskal sintaxia: Komplementazioa eta nominalizazioa*, University of The Basque Country, doctoral dissertation.
- Hale, K. and S. Keyser, 1986, 'Some Transitivity Alternations', *Lexicon Project Working Papers*, Center for Cognitive Science, MIT.
- Heim, I., 1982, *The Semantics of Definite and Indefinite Noun Phrases*, University of Massachusetts, doctoral dissertation.
- Higginbotham, J., 1985, 'On Semantics', *LI*.
- Hornstein, N., Rosen, S. and J. Uriagereka, (in progress) *(In)definiteness, (Un)specificity, and The Predicate/Argument Distinction*. National Science Foundation Grant Proposal.
- Horvath, J., 1981, *Aspects of Hungarian Syntax and the Theory of Grammar*, University of California at Los Angeles, doctoral dissertation.

- Huang, J., 1984, 'On The Distribution and Reference of Empty Pronouns', *LI*.
- Johnson, K., 1985, Massachusetts Institute of Technology, doctoral dissertation.
- Kayne, R., 1984, *Connectedness and Binary Branching*, Foris.
- Kiss, K., 1987, *Configurationality in Hungarian*, Reidel.
- Koopman, H., 1984, *The Syntax of Verbs*, Foris.
- Laka, I., 1985, 'Azpikotasunaren baldintzaz: muga adabegiak euskaraz', in *Euskal Sintaxiaren zenbait arazo*, University of The Basque Country.
- , 1988, 'Configurational Heads in Inflectional Morphology: The Structure of the Inflected Forms in Basque', *MIT Working Papers in Linguistics*
- , *Negation in Syntax: On the Nature of Functional Categories and Projections*, Massachusetts Institute of Technology, doctoral dissertation.
- and J. Uriagereka, 1987, 'Barriers on Basque and Vice-Versa', *Proceedings of NELS*.
- Larson, R., 1988, 'On The Double Object Construction', *LI*.
- Levin, B., 1984, *On the Nature of Ergativity*, Massachusetts Institute of Technology, doctoral dissertation.
- Mahajan, A., 1990, *On A-A' Distinction*, Massachusetts Institute of Technology, doctoral dissertation.
- McDaniel, D., 1989, *Conditions on Wh-Chains*, City University of New York, doctoral dissertation.
- Mitxelena, K., 1981, 'Galdegai eta mintzagaia euskaraz', in *Euskal Linguistika eta Literatura: bide berriak*, University of Deusto.
- Ortiz de Urbina, J., 1989, *Parameters in The Grammar of Basque*, Foris.
- Partee, B., 1988, 'Syntactic Categories and Semantic Types', ms. University of Massachusetts.
- Perlmutter, D. and P. Postal, 1983, 'The 1-Advancement Exclusiveness Law', in Perlmutter and Rosen, eds.) *Studies In Relational Grammar 2*, University of Chicago Press.
- Pollock, J., 1988, 'Verb Movement, Universal Grammar, and The Structure of IP', *LI*.
- Postal, P., 1969, 'On So-called Pronouns', in Reibel and Schane, (eds.) *Modern Studies in English*, Prentice Hall.
- Pustejovsky, J., 1988, 'The Syntax of Event Structure', ms. Brandeis University.
- Raposo, E. and J. Uriagereka, 1990, 'Long Distance Case Assignment', *LI*.
- , (in progress) *Agreement Relations in Western Romance*, NSF grant proposal.
- De Rijk, R., 1978, 'Topic Fronting, Focus Positioning, and The Nature of The VP in Basque', in Jensen, (ed.) *Studies in Fronting*.
- Rizzi, L., 1982, *Issues in Italian Syntax*, Foris.
- , 1990, *Relativized Minimality*, MIT Press.
- Salaburu, P., 1986, 'La teoria del ligamiento en la Lengua Vasca', Anuario del Seminario Julio de Urkijo.
- Tiedeman, R., 1989, *Government and Syntactic Conditions on Syntactic Relations*, University of Connecticut, doctoral dissertation.
- Torrego, E., 1984, 'On Inversion in Spanish and Some of its Effects', *Linguistic Inquiry*.
- , (in progress) *Pronouns and Determiners. A DP Analysis of Spanish Nominals*, ms. University of Massachusetts.
- Torrego, E. and J. Uriagereka, (in progress) 'Indicative Dependents', ms. University of Maryland, University of Massachusetts.
- Uriagereka, J., 1987, 'Variables in Basque and Governance', *UConn Working Papers in Linguistics*.
- , 1988, *On Government*, University of Connecticut, doctoral dissertation.
- , (in progress) *In Construction With*, ms. University of Maryland.
- Uribe-Etxebarria, M., 1990, University of Connecticut Ma. dissertation.
- Webelhuth, G., 1988, *Syntactic Saturation Phenomena in the Modern Germanic Languages*, University of Massachusetts, doctoral dissertation.
- Zagona, K., 1988, *Verb Phrase Syntax*, Kluwer.